

GENERAL PRODUCT GUIDE 2018





Caleffi S.p.A. - Corporate Headquarters - Plant 1
Fontaneto d'Agogna - ITALY



1 COMPONENTS FOR CENTRAL HEATING SYSTEMS

2 AIR AND DIRT SEPARATION DEVICES

3 VALVES AND ACCESSORIES FOR RADIATORS

4 DISTRIBUTION MANIFOLDS, ZONE VALVES, BOXES AND ACCESSORIES

5 RADIANT PANEL SYSTEM CONTROL

6 COMPONENTS FOR DOMESTIC WATER SYSTEMS

7 BACKFLOW PREVENTION DEVICES

8 BALANCING DEVICES

9 FITTINGS

10 GAS SAFETY

11 EXPANSION VESSELS, MIXING VALVES, CHRONO-THERMOSTATS

12 HEAT SYSTEMS

13A COMPONENTS FOR SOLAR THERMAL SYSTEMS

13B COMPONENTS FOR HEAT PUMP SYSTEMS

13C COMPONENTS FOR BIOMASS SYSTEMS

14 SPARE PARTS - For spare parts, please contact the appropriate department

15 FITTING COUPLING - PRODUCT DIMENSIONS are available on www.caleffi.com

GENERAL INDEX

SERIES	Page	SERIES	Page	SERIES	Page	SERIES	Page	SERIES	Page	SERIES	Page	SERIES	Page
100	187	203	55	263	255	333	136-166	4004	46-49	507	30	5334	128
103	183	204	55	264	252	334	136-166	4005	61	5080	31	5334..H	128-130
106	258-259	205	48	265	253	336	13	401	44	5081	31	5335	129
108	259	209	46-48-54	278	244-245	337	31	402	44	510	12	5335..H	131
110	260-261	210	59	279	245	338	44-49	411	60	5121	7	5336	129
111	262	210	58-59	280	246	3380	47	412	60	513	9	5336..H	131
112	261	220	52	281	267	339	44	421	45	514	9	5337	129
113	261	221	52	282	268	340	60	422	45	519	12-104-187	5337..H	131
116	150-151	222	52	2850	270	341	60	425	45	520	137-141	5338	129
120	178-182	223	52	2851	272	342	44-49-60	426	45	5200	140	5338..H	131
121	176	224	52	2853	273	343	44-60	431	44-60	5201	141	5339	129
125	179-182	225	53	2855	274	347	98-99	432	44-60	5202	113	534	153
126	177	226	53	286	271	347...S1	119	437	47-66-67	521	137	5350	132
127	174	227	52	3006	14	348	62	438	66-67	5213	139-140	5350..H	133
128	175	230100	51-65	3010	69-70	349	86-88	446	98	5217	139	5351	132
130	185	230	50	3011	69-70	350	86	447	66	5218	138	5360	134
130 _{≥ DN 65}	185	231	50	3012	69-70	351	86	4490	52	5219	138	5362	134
130	187-262	232	50	3013	69-70	354	86-88-156	4496	63	522	137	5365	134
132	184	233	50	3014	70	356	87	4499	63	5230	142	5366	134
132 _{≥ DN 65}	184	234	50	3015	70	357	87	4501	62	5231	142	5370	152
140	123-186	237	50	302	13	360	72-156	452	62-63	524	143	537	134
140 _{≥ DN 65}	186	240	246	3037	136-166	361	72	453	63	525	152	538	15-187
142	185-186	250	242	3038	136-166	362	72	454	63	5261	155	539	133
14501	171-173	251	242-243	3041	167	363	72	455	62	527 EST	6	540	11
145	172	2521	250	3045	167	3640	87	456	61	528	154	541	10
145 _{≥ DN 32}	173	2522	251	3046	167	3641	87-156	459	63	5280	154	542	11-264
146	173	2523	250	3047	167	3642	87-96-156	472	55	5281	154	543	11-264
149	171	2527	251	3048	167	3642...S1	119	475	55	529	12-265	544	11-265
1520	25-105-217	253	242	305	13	381	64	501	28	530	8	5451	42
1522	275	2540	247	309	9-153-256	382	64-95	5020	28-119	531	8	5453	40-41
161	25-105-107-217-231	2543	247	311	7	383	47-64-95	5021	28-29	5320	7	546	34-35
165	24-102-104	2544	247	312	7-9	384	64-95	5022	29	5321	8	5461	34
166	24-102	2545	247	313	7	385	95	5024	29	5322	8	5462	36
167	24-103-104	2546	247	314	7	386	95-97-122	5025	29	5327	8	5463	37
171	106	2547	247	315	15	3871	64	5026	29	5328	8	5466	37
172	109	2548	247	319	155	3872	65	5027	29	5330	128-129	5468	37
182	110-112-117	255	246	3230	136-166	391	93-122	503	18	5330..H	130-131	547	12
200	46-54	258	248	324	135-165	391...S1	119	504	30	5331	128	547 _{≥ DN 100}	12
201	54	259	246	327	12	392	96	505	31	5331..H	130	548	20
202	55	262	254	328	63	4001	46-48	5054	31	5332	128	5495	21
		2620	249	332	136-166	4003	46-49	5055	31	5332..H	128-130	550	23

THE CALEFFI GROUP



Caleffi S.p.A. - Corporate Headquarters - Plant 1
Fontaneto d'Agogna - ITALY



Caleffi S.p.A. - Plant 2
Fontaneto d'Agogna - ITALY



Caleffi S.p.A. - Plant 3
Gattico - ITALY



PRESSCO S.p.A. - Hot pressing and mechanical processing of brass components
Invorio - ITALY

GENERAL INDEX

SERIES	Page	SERIES	Page	SERIES	Page	SERIES	Page	SERIES	Page	SERIES	Page	SERIES	Page
551	28-32-33	584	97	626	15	661	111-124	70026	223	8562	208	914	195
5520	6	585	97	627	219	662	90-91-120-122	70028	223	8563	209	930	191-195
552080	6	586	97	628	219	6620	91	70029	223	8565	209	933	191
5521	6	588	190-247	630	77	6621	91	738	218	860 \geq DN75	196	936	49-64-191
553	14	5881	190	632	77	663	92-93	739	218	860	196	940	192
554	14	5890	73	633	77	6630	93	740	220	861 \geq DN 75	196	941	192
5557	153-212	5891	73	635	77	6631	93	741	220	861	196	942	64-192
556	212	591	99	636	84	664	120	75025	248	862	197	943	192
5560	18	592	88	6370	214	665	121	7504	237	863 \geq DN 75	197	944	192
557	18	598	89	637	84	666...S1	118	7507	237	863	197	945	192
5580	16-213	5991	96-156	638	82-83	667...S1	118	7550	147	864	197	946	192
558	16-213	5993	96-156	639	85	668...S1	118-119	765	231	865	197	947	192
559	22-23	5994	96	641	79	669	96	766	231	866	198	948	192
560	31-64	5995	96	642	79	670	116	767	231	867	198	960	199
561	29	5996	91-119	643	79	671	116	789	233-234-239	868	198	961	199
5620	30	6000	145-147	6440	76-80-81	675	112-117-122-	789110	234	869	198	962	199
5621	30	6000 EST	144	6442	76-80	677	124	789603	233	870	198	963	199
5622	30	6001	146	6443	81-249	676	78	7900	230	871	198-261	964	199
568	212	6002	149	6443 3BY	76	677	78	7940	238	875	196	966	200
5709	40	6005	148	6444	76	678	78	7941	238	876	196	967	200
570	161-162	603	157-256	6450	75	679	68	7942	238	877	202	968	200
570 \geq DN 150	162	610	215	6452	75	679	66-67-98-99	7945	236	878	202	970	200
572	160-234	611	215	6453	75	680	98-99-122	7949	236	879	202	975	199
573	160	612	215	6459	75	681	47-66-67	796	229	886	202	980	200
573001	14	6120	214	6460	74	683	12	798	239	887	202	986	200
574	160-161	613	17-213	6470	74	687	18	799	228	888	197	R59681	30
574000	15	615	89	6480	74	688	18-96	837	207	890	201	R59720	30
574001	15	6150	213	6489	74	689	18	838	208	891	201	R96006	191
574011	14	6151	213	6490	74	690	16	839	206	893	201	SATK10	234
575	161	6152	213	650	89	691	16	841	205	894	201	SATK12	235
575 \geq DN150	162	616	216	6509	155	692	16	842	205	900	193	SATK15	235
5750	162	617	185-216	6561	56-78-94-125-172	693	16	8460	205	903	193	SATK16	235
576	135	618	218	6562	57-78-94-125-171	694	16	8461	205	904	193	SATK20	232
577	19-162	619	219	6563	56-78-94-125	695	16	847	204	9050	193	SATK30	233
578	135	620	219	6564	57-78-94-125	7000	222-224-227-238	848	204	9057	194	SATK32	234
5790	38-39	6205	125-219	657	96	70006	225	850	204	9058	194	SATK40	233
579	19-162	621	17	658	73-91-119	70008	225	852	205	9060	194	SATK50	236
580010	15	622	17	659	73-124	70009	225	8540	206	9067	194	KIT54534	40
580	164	623	17	660	124	7001	226-227	8541	207	9068	195		
5812	99	624	17			7002	222-223	855	209	910	195		
583	97	625	17-213					8561	208	913	195		

THE CALEFFI GROUP

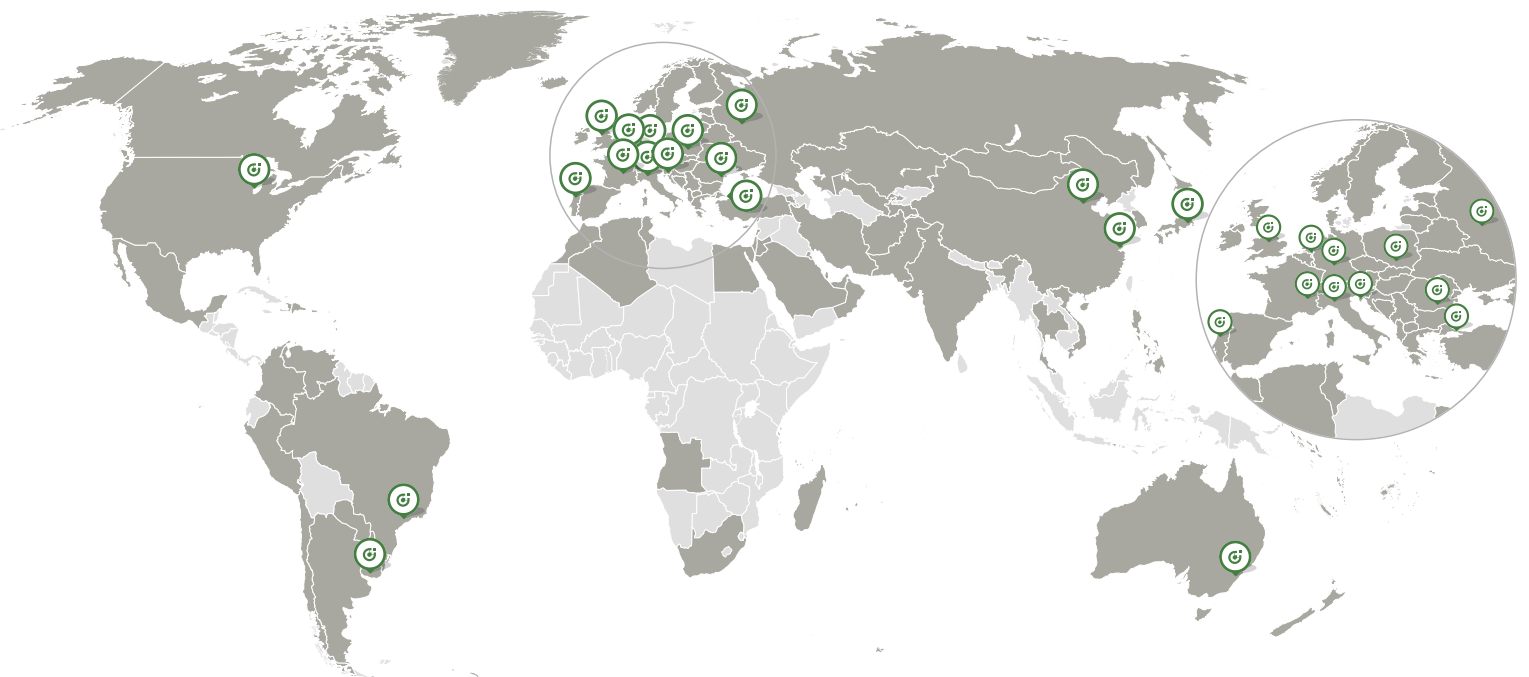

COMPONENTS FOR CENTRAL HEATING SYSTEMS

This diagram is just an indication

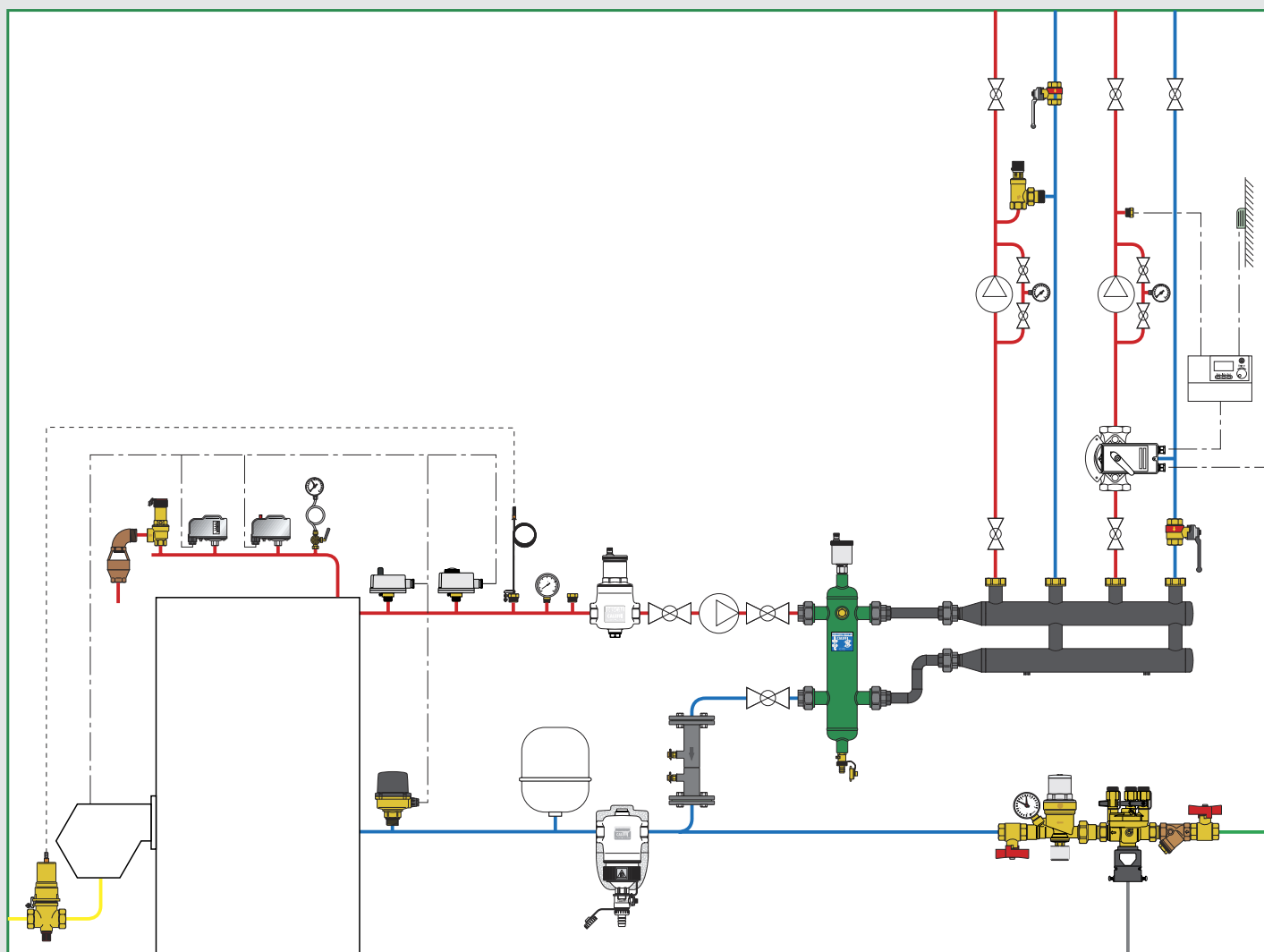

- Safety relief valves**
- Fuel shut-off valves**
- Temperature relief valves**
- Differential by-pass valve**
- Air separators**
- Automatic filling units**
- Thermostats, pressure switches, flow switches**
- Pressure gauges and temperature gauges**
- Strainers**
- Hydraulic separators**
- Manifolds for central heating system**
- Distribution units**
- Temperature regulators**



527 EST

tech. broch. 01253

Safety relief valve.
Female connections.
Discharge overpressure 10%.
Closing differential 20%.
PN 10.
Temperature range: 5–110°C.
Settings: 2,25 - 2,5 - 2,7 - 3 - 3,5 - 4 - 4,5 -
5 - 5,4 - 6 bar.



Code

5274 ●●EST	1/2" x 3/4"	1	-
5275 ●●EST	3/4" x 1"	1	-
5276 ●●EST	1" x 1 1/4"	1	-
5277 ●●EST	1 1/4" x 1 1/2"	1	-



**527 EST
Special settings**

tech. broch. 01253

Safety relief valve.
Female connections.
Discharge overpressure 10%.
Closing differential 20%.
PN 10.
Temperature range: 5–110°C.
Non-standard pressure settings available
on request: 1 - 1,5 - 2 - 7 - 8 bar.



Code

5274 ●●EST	1/2" x 3/4"	1	-
5275 ●●EST	3/4" x 1"	1	-
5276 ●●EST	1" x 1 1/4"	1	-
5277 ●●EST	1 1/4" x 1 1/2"	1	-



5521

tech. broch. 01053

Elbow tundish.

Code

552140	1/2" M x 3/4" F	1	-
552150	3/4" M x 3/4" F	1	-
552160	1" M x 1 1/4" F	1	-
552170	1 1/4" M x 1 1/4" F	1	-

5520

tech. broch. 01053

Straight tundish.



Code

552050	3/4" F x 3/4" F	1	25
552070	1 1/4" F x 1 1/4" F	1	-

5520

tech. broch. 01053

Pre-formed "special" tundish.



Code

552080	1 1/2" F	1	-
---------------	----------	---	---

●● Code completion

bar	●●	bar	●●	bar	●●
1	10	2,7	27	5	50
1,5	15	3	30	5,4	54
2	20	3,5	35	6	60
2,25	22	4	40	7	70
2,5	25	4,5	45	8	80



311

tech. broch. 01253

Safety relief valve.
Female connections.
Discharge overpressure 20%.
Closing differential 20%.
PN 10.
Temperature range: 5–110°C.
Settings:
1,5 - 2 - 2,5 - 3 - 3,5 - 4 - 5 - 5,5 - 6 - 7 - 8 - 9 bar
(1,5 bar for only 1/2" size,
2 - 5,5 - 9 bar for only 3/4" size).



Code				
3114 ●●	1/2"		1	50
3115 ●●	3/4"		1	50



311

tech. broch. 01253

Safety relief valve.
Female connections.
Discharge overpressure 20%.
Closing differential 15%.
Power rating: 110 kW.
Temperature range: 5–110°C.
Certified to NF P 52-001 - Class 2.



Code				
311431	1/2" 3 bar		1	50



312

tech. broch. 01253

Safety relief valve.
Male - female connections.
Discharge overpressure 20%.
Closing differential 20%.
PN 10.
Temperature range: 5–110°C.
Settings: 1,8 - 2,5 - 3 - 3,5 - 4 - 5 - 6 - 7 - 8 bar.



Code				
3124 ●●	1/2"		1	50



313

tech. broch. 01253

Safety relief valve.
Female connections.
With pressure gauge connection.
Discharge overpressure 20%.
Closing differential 15%.
Power rating: 110 kW.
Temperature range: 5–110°C.
Certified to NF P 52-001 - Class 2.



Code				
313433	1/2" 3 bar		50	-



313

tech. broch. 01253

Safety relief valve.
Female connections.
Discharge overpressure 20%.
Closing differential 20%.
PN 10.
Temperature range: 5–110°C.
Max. pressure gauge temperature: 90°C.
Settings: 2,5 - 3 - 6 - 7 - 8 bar.



Code				
3134 ●●	1/2"	with pressure gauge	1	50
3135 ●●	3/4"	with pressure gauge	1	50
313432	1/2" 3 bar	with pressure gauge connection	1	50
313532	3/4" 3 bar	with pressure gauge connection	1	50



5121

Safety relief valve.
Male - female connections.
Discharge overpressure 20%.
Closing differential 15%.
Power rating: 110 kW.
Temperature range: 5–110°C.
Certified to NF P 52-001 - Class 2.



Code				
512131	1/2" 3 bar		50	-



314

tech. broch. 01253

Safety relief valve.
Male - female connections.
Discharge overpressure 20%.
Closing differential 20%.
PN 10.
Temperature range: 5–110°C.
Max. pressure gauge temperature: 90°C.
Settings: 2,5 - 3 - 6 - 7 - 8 bar.



Code				
3144 ●●	1/2"	with pressure gauge	1	50
314432	1/2" 3 bar	with pressure gauge connection	1	50
314462	1/2" 6 bar	with pressure gauge connection	1	50



5320

Safety relief valve.
Female connections.
Discharge overpressure 20%.
Closing differential 20%.
Power rating: 50 kW.
Max. percentage of glycol: 50%.
Temperature range: 5–120°C.



Code				
532042	1/2" x 3/4"	2,5 bar	1	50
532043	1/2" x 3/4"	3 bar	1	50



5321

Safety relief valve.
Female connections. With pressure gauge.
Discharge overpressure 20%.
Closing differential 20%.
Power rating: 50 kW.
Max. percentage of glycol: 50%.
Temperature range: 5–120°C.
Max. pressure gauge temperature: 90°C.



Code			
532142	1/2" x 3/4" 2,5 bar	1	50
532143	1/2" x 3/4" 3 bar	1	50



5322

Safety relief valve. Female connections.
With pressure gauge connection.
Discharge overpressure 20%.
Closing differential 20%.
Power rating: 50 kW.
Max. percentage of glycol: 50%.
Temperature range: 5–120°C.



Code			
532242	1/2" x 3/4" 2,5 bar	1	50
532243	1/2" x 3/4" 3 bar	1	50



5327

Safety relief valve.
Male - female connections.
Discharge overpressure 20%.
Closing differential 20%.
Power rating: 50 kW.
Max. percentage of glycol: 50%.
Temperature range: 5–120°C.



Code			
532742	1/2" x 3/4" 2,5 bar	48	–
532743	1/2" x 3/4" 3 bar	48	–



5328

Safety relief valve.
Male - female connections.
With pressure gauge connection.
Discharge overpressure 20%.
Closing differential 20%.
Power rating: 50 kW.
Max. percentage of glycol: 50%.
Temperature range: 5–120°C.



Code			
532842	1/2" x 3/4" 2,5 bar	1	50
532843	1/2" x 3/4" 3 bar	1	50



530

Safety relief valve. Female connections.
Discharge overpressure 20%.
Closing differential 20%.
Max. percentage of glycol: 50%.
Temperature range: 5–120°C.



Code			
530525	3/4" x 1" 2,5 bar	1	25
530530	3/4" x 1" 3 bar	1	25

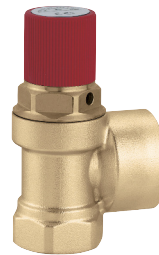

530

Safety relief valve. Female connections.
Discharge overpressure 20%.
Closing differential 20%.
Max. percentage of glycol: 50%.
Temperature range: 5–120°C.
Settings: 2,5 - 3 - 4 - 5 - 6 - 7 - 8 - 9 bar.
Settings 4 - 5 - 6 - 7 - 8 - 9 bar without TÜV certification.



Code			
5306 ●●	1" x 1 1/4"	1	25
5307 ●●	1 1/4" x 1 1/2"	1	10



531

Safety relief valve for domestic water systems.
Female connections.
Discharge overpressure 20%.
Closing differential 20%.
Medium: water.
Temperature range: 5–95°C.
Settings: 4 - 6 - 8 - 10 bar.



Code			
5314 ●●	1/2" x 3/4"	1	50
5315 ●●	3/4" x 1"	1	25



531

Safety relief valve for domestic water systems.
Female connections.
Discharge overpressure 20%.
Closing differential 20%.
Medium: water.
Temperature range: 5–95°C.
Settings: 4 - 6 - 8 - 10 bar.



Code			
5316 ●●	1" x 1 1/4"	1	25
5317 ●●	1 1/4" x 1 1/2"	1	10



513

tech. broch. 01253

Safety relief valve.
Female connections.
Discharge overpressure 20%.
Closing differential 20%.
PN 10.
Temperature range: 5–110°C.
Settings: 1,5 - 2 - 2,5 - 3 - 3,5 - 6 - 7 - 8 bar.



Code				
5134 ●●	1/2"		1	50



513

tech. broch. 01253

Safety relief valve.
Female connections.
Discharge overpressure 20%.
Closing differential 20%.
PN 10.
Temperature range: 5–110°C.
Settings:
1,5 - 2 - 2,5 - 3 - 3,5 - 4 - 5,5 - 6 - 7 - 8 - 9 bar
(1,5 - 2 - 4 - 5,5 - 9 bar only for 1" x 1 1/4" size).



Code				
5136 ●●	1" x 1 1/4"		1	25
5137 ●●	1 1/4" x 1 1/2"		1	10



514

tech. broch. 01253

Safety relief valve.
Male - female connections.
Discharge overpressure 20%.
Closing differential 20%.
PN 10.
Temperature range: 5–110°C.
Settings: 2 - 2,5 - 3 - 3,5 - 4 - 5 - 6 - 7 - 8 bar.



Code				
5144 ●●	1/2"		1	50



312

Safety relief valve.
CR dezincification resistant alloy body.
For domestic water systems.
M x Ø 15 compression end.
With stainless steel seat.
Discharge overpressure 20%.
Closing differential 20%.
Temperature range: 5–110°C.
Settings: 100 - 200 - 400 - 600 kPa.
5 - 8 bar.



Code				
312417	1/2" M x Ø 15 - 100 kPa		50	-
312406	1/2" M x Ø 15 - 200 kPa		50	-
312405	1/2" M x Ø 15 - 400 kPa		50	-
312407	1/2" M x Ø 15 - 600 kPa		50	-
312415	1/2" M x Ø 15 - 5 bar		50	-
312418	1/2" M x Ø 15 - 8 bar		50	-



309

tech. broch. 01130

Temperature and pressure relief valve.
CR dezincification resistant alloy body.
For domestic water system, to protect the hot water storage.
Set temperature: 90°C.
Discharge rating: 1/2" - 3/4" x Ø 15: 10 kW.
3/4" x Ø 22: 25 kW.
Settings: 3 - 4 - 6 - 7 - 10 bar.
Settings certified to EN 1490: 4 - 7 - 10 bar.



Code			Probe length (mm)		
309430	1/2" M x Ø 15	3 bar	100	1	20
309440	1/2" M x Ø 15	4 bar	100	1	20
309460	1/2" M x Ø 15	6 bar	100	1	20
309470	1/2" M x Ø 15	7 bar	100	1	20
309400	1/2" M x Ø 15	10 bar	100	1	20
309542	3/4" M x Ø 15	4 bar	100	1	20
309530	3/4" M x Ø 22	3 bar	100	1	20
309560	3/4" M x Ø 22	6 bar	100	1	20
309570	3/4" M x Ø 22	7 bar	100	1	20
309500	3/4" M x Ø 22	10 bar	100	1	20
309435	1/2" M x Ø 15	3 bar	200	1	20
309445	1/2" M x Ø 15	4 bar	200	1	20
309465	1/2" M x Ø 15	6 bar	200	1	20
309475	1/2" M x Ø 15	7 bar	200	1	20
309405	1/2" M x Ø 15	10 bar	200	1	20
309547	3/4" M x Ø 15	4 bar	200	1	20
309535	3/4" M x Ø 22	3 bar	200	1	20
309565	3/4" M x Ø 22	6 bar	200	1	20
309575	3/4" M x Ø 22	7 bar	200	1	20
309505	3/4" M x Ø 22	10 bar	200	1	20



309

Temperature and pressure relief valve.
CR dezincification resistant alloy body.
For domestic water system, to protect the hot water storage.
Set temperature: 95°C.
Discharge rating: 25 kW.
Setting: 6 bar.
For systems with nominal pressure of 400 kPa.



Probe length (mm)

Code			Probe length (mm)		
309563	3/4" M x Ø 22	6 bar	100	1	20

•• Code completion

bar	••	bar	••	bar	••
1,5	15	3,5	35	7	70
1,8	28	4	40	8	80
2	20	5	50	9	90
2,5	25	5,5	55	10	10
3	30	6	60		

FUEL SHUT-OFF VALVES

541

tech. broch. 01046

Fuel shut-off valve.
Brass body.
Female threaded connections.
Max. working pressure: 50 kPa.
Capillary length: 5 or 10 m.
Settings: 98°C, 110°C, 120°C, 140°C,
160°C, 180°C.



Code	Settings		
54104 •	1/2" ...°C	1	-
54105 •	3/4" ...°C	1	-
54106 •	1" ...°C	1	-
54107 •	1 1/4" ...°C	1	-
54108 •	1 1/2" ...°C	1	-
54109 •	2" ...°C	1	-
541140*	1/2" 110°C	1	-
541150*	3/4" 110°C	1	-
541160*	1" 110°C	1	-
541170*	1 1/4" 110°C	1	-
541180*	1 1/2" 110°C	1	-
541190*	2" 110°C	1	-

* Capillary length 5 m only

541

tech. broch. 01046

Fuel shut-off valve
for high pressure use.
Bronze body.
Flanged connections PN 16.
To be coupled
with flat counterflanges EN 1092-1.
Max. working pressure: 50 kPa.
Capillary length: 5 or 10 m.
Settings: 98°C, 110°C, 120°C, 140°C,
160°C, 180°C.



Code	Settings		
54161 •	DN 65 ...°C	1	-
54181 •	DN 80 ...°C	1	-
541630*	DN 65 110°C	1	-
541830*	DN 80 110°C	1	-

* Capillary length 5 m only

541

tech. broch. 01046

Fuel shut-off valve.
Bronze body.
Flanged connections PN 16.
To be coupled
with flat counterflanges EN 1092-1.
Max. working pressure: 11 kPa.
Capillary length: 5 or 10 m.
Settings: 98°C, 110°C, 120°C, 140°C,
160°C, 180°C.



Code	Settings		
54160 •	DN 65 ...°C	1	-
54180 •	DN 80 ...°C	1	-
541620*	DN 65 110°C	1	-
541820*	DN 80 110°C	1	-

* Capillary length 5 m only

● Code completion

	541	540	capillary 5 m	capillary 10 m
setting	98°C	97°C	0	1
	120°C	120°C	2	3
	140°C	140°C	4	5
	160°C	160°C	6	7
	180°C	180°C	8	9

FUEL SHUT-OFF VALVES



540

tech. broch. 01074

Fuel shut-off valve.
Aluminium body.
Female threaded connections.
Max. working pressure: 50 kPa.
Capillary length: 5 m.
Setting: 98°C.



Code	Setting		
540040	1/2"	98°C	1 -
540050	3/4"	98°C	1 -
540060	1"	98°C	1 -
540070	1 1/4"	98°C	1 -
540080	1 1/2"	98°C	1 -
540090	2"	98°C	1 -

540

tech. broch. 01074

Fuel shut-off valve.
Aluminium body.
Flanged connections PN 16.
To be coupled
with flat counterflanges EN 1092-1.
Max. working pressure: 50 kPa.
Capillary length: 5 or 10 m.
Settings: 97°C, 110°C, 120°C, 140°C,
160°C, 180°C.



Code	Settings		
54060 ●	DN 65 ...°C		1 -
54080 ●	DN 80 ...°C		1 -
54010 ●	DN 100 ...°C		1 -
540610*	DN 65 110°C		1 -
540810*	DN 80 110°C		1 -
540110*	DN 100 110°C		1 -

* Capillary length 5 m only

TEMPERATURE RELIEF VALVES



542

tech. broch. 01001

Temperature relief valve, with fail-safe action.
Manual reset for burner switch off
or alarm activation.
Working pressure: 0,3 bar ≤ P ≤ 10 bar.
Temperature range: 5–100°C.
Setting temperature: 98°C and 99°C.
Discharge rating:
1 1/2" x 1 1/4" - 136 kW.
1 1/2" x 1 1/2" - 419 kW.



Code	Setting		
542870	1 1/2" M x 1 1/4" F	98°C	1 10
542880	1 1/2" M x 1 1/2" F	99°C	1 10

543

tech. broch. 01057

Temperature safety relief valve,
with double safety sensor,
for solid fuel generators.
Brass body. Chrome plated.
Max. working pressure: 10 bar.
Temperature range: 5–110°C.
Setting temperature: 98°C (0/-4°C).
Discharge flow rate with Δp of 1 bar
and T=110°C: 3000 l/h.
Capillary length: 1300 mm.
Certified to EN 14597.

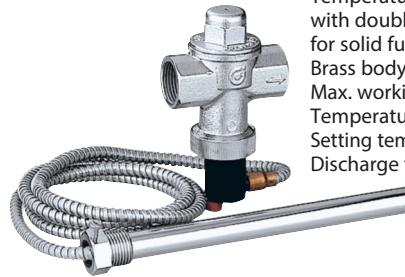

Code	Setting		
543513	3/4" F	98°C	1 10
543503	3/4" F	98°C yellow brass body	1 10

544

tech. broch. 01058

Temperature relief valve, with positive action
with automatic filling.
For solid fuel generators.
Max working pressure: 6 bar.
Max. working temperature: 110°C.
Temperature range: 5–110°C.
Ambient temperature range: 1–50°C.
Setting temperature: 100°C (0/-5°C).
Discharge flow rate with Δp of 1 bar
and T=110°C: 1600 l/h.
Capillary length: 1300 mm.

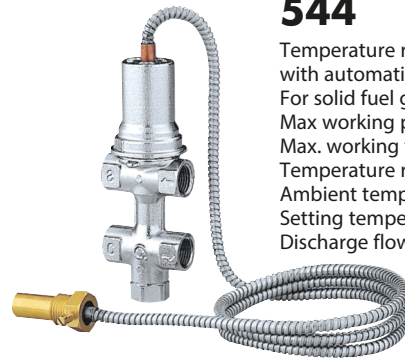

Code	Setting		
544400	1/2"	100°C	1 10

544

Temperature relief valve
with automatic filling for solid fuel generators,
with knob for manual discharge.
Max. working pressure: 6 bar.
Max. working temperature: 120°C.
Setting temperature: 100°C (0/-5°C).
Discharge flow rate with Δp of 1 bar
and T=110°C: 1800 l/h.



Code	Setting		
544501	3/4"	100°C	1 -



529

tech. broch. 01226

Draught regulating valve.
Male threaded connection.
Adjustment temperature range: 30–90°C.
Certified to EN 14597.



Code		Pocket length (mm)		
529050	3/4" M ISO 7/1	58	1	10
529150	3/4" M ISO 7/1	58	1	10
529151	3/4" M ISO 7/1	78	1	10



327 BALLSTOP

tech. broch. 01021

Ball valve with built-in check valve for heating systems.
Low head losses.
Max. working pressure: 16 bar.
Temperature range: 5–110°C.

Code				
327400	1/2"	butterfly handle	10	–
327500	3/4"	butterfly handle	10	–
327600	1"	lever handle	4	–
327700	1 1/4"	lever handle	4	–
327800	1 1/2"	lever handle	2	–
327900	2"	lever handle	1	–



510

tech. broch. 01045

Anti-thermosiphon check valve to prevent natural circulation of water.
Removable cap allows straight or angled installations.
Max. working pressure: 10 bar.
Temperature range: 5–110°C.

Code				
510500	3/4"		1	20
510600	1"		1	20
510700	1 1/4"		1	20



519

tech. broch. 01007

Differential by-pass valve, adjustable with graduated scale.
Max. working pressure: 10 bar.
Temperature range: 0–110°C.
Max. percentage of glycol: 30%.



Code		Setting range m.w.g.		
519500	3/4"	1–6	1	50
519504	3/4"	10–40	1	50
519700	1 1/4"	1–6	1	10



547

Air separator.
Cast iron body.
Female connections.

Code				
547060	1"		1	10
547070	1 1/4"		1	10
547080	1 1/2"		1	10
547090	2"		1	10
547200	2 1/2"		1	–
547300	3"		1	–



547

Air separator.
Steel body.
Flanged connections PN 16.
To be coupled with flat counterflanges EN 1092-1.

Code				
547400	DN 100		1	–
547500	DN 125		1	–



683

tech. broch. 01040

Flow rate metering device.
Female connections.
Equipped with pressure test ports.
Max. working pressure: 10 bar.
Temperature range: -5–110°C.

Code				
683005	3/4"		1	–
683006	1"		1	–



683

tech. broch. 01040

Flow rate metering device.
Steel body. Flanged connections.
To be coupled with flat counterflanges EN 1092-1 DN 32–DN 100, PN 6; DN 125–DN 200, PN 16.
Temperature range: -5–110°C.
Equipped with pressure test ports, counterflanges, bolts and seals.

Code				
683030	DN 32		1	–
683040	DN 40		1	–
683050	DN 50		1	–
683060	DN 65		1	–
683080	DN 80		1	–
683100	DN 100		1	–
683120	DN 125		1	–
683150	DN 150		1	–
683170	DN 175		1	–
683200	DN 200		1	–

For flow rate measurement, the electronic measuring station 130 series (page 187), can be used.

336

Instrument holder for heating systems. Equipped with automatic shut-off cock for expansion vessel and male connection for safety valve 531 series.

Max. working temperature: 110°C. Up to 50 kW.



Code			
336600	3/4"	2	10

336

Assembled instrument holder for heating systems. Equipped with air vent, safety relief valve, pressure gauge and automatic shut-off cock for expansion vessel.

Max. working temperature: 110°C. Up to 50 kW.



Code			
336630	3/4" 3 bar with automatic shut-off cock	1	5
336631	3/4" 3 bar with automatic ball shut-off cock	1	5

302

Combined air separator with heating system accessories. Equipped with air vent, safety relief valve and pressure gauge.

Max. working temperature: 110°C. Up to 50 kW.

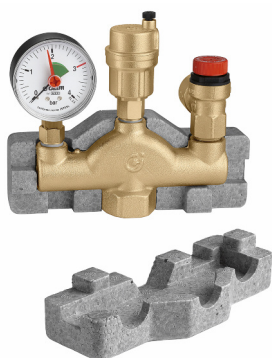

Code			
302630	1" 3 bar	1	10
302631	1" 3 bar with pre-formed insulation	1	10

305

Instrument holder kit in composite material for heating systems.

Equipped with air vent, safety relief valve in composite material, pressure gauge, automatic shut-off cock for expansion vessel and fixing bracket.

With insulation.

Temperature range: 5–90°C. Up to 50 kW.

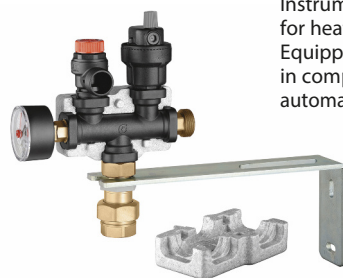

Code			
305503	3/4" 3 bar TÜV	1	10

305

Instrument holder in composite material for heating systems.

Equipped with air vent, safety relief valve in composite material and pressure gauge.

With insulation.

Temperature range: 5–90°C. Up to 50 kW.



Code			
305663	1" 3 bar TÜV	1	5

305

Instrument holder in composite material for heating systems.

Equipped with air vent in composite material, safety relief valve and pressure gauge.

With insulation.

Temperature range: 5–90°C. Up to 50 kW.



Code			
305572	3/4" 2,5 bar TÜV	1	5
305671	1" 1,8 bar	1	5
305673	1" 3 bar NF	1	5
305674	1" 4 bar without insulation	1	5

3006 ROBOFIL

Boiler filling loop.
CR dezincification resistant alloy body.
 Equipped with double check valve with shut-off valve, hose connection and shut-off valve.

Max. working pressure: 10 bar.
 Max. working temperature: 95°C.
 Flexible hose length: 400 mm.



Code		
300600	1	10

553

tech. broch. 01061

Pre-adjustable automatic filling unit, anti-scale, inspectionable, with pressure setting indicator, manual cock, strainer, check valve.
 Setting pressure range: 0,2–4 bar.
 Max. inlet pressure: 16 bar.
 Max. working temperature: 65°C.



Code		
553540	1/2" with pressure gauge connection	1 10
553640	1/2" with pressure gauge	1 10

553

Pre-adjustable automatic filling unit, anti-scale, inspectionable, with pressure setting indicator, manual cock, strainer and check valve. With hose connection.
 Setting pressure range: 0,2–4 bar.
 Max. inlet pressure: 16 bar.
 Max. working temperature: 65°C.



Code		
553740	1/2" with pressure gauge connection	1 10
553840	1/2" with pressure gauge	1 10

553

tech. broch. 01025

Automatic filling unit, with manual cock, strainer, check valve.
 Setting pressure range: 0,3–4 bar.
 Max. inlet pressure: 16 bar.
 Max. working temperature: 70°C.



Code		
553040	1/2" with pressure gauge connection	1 10
553140	1/2" with pressure gauge	1 10

554

tech. broch. 01125

Pre-adjustable automatic filling unit for high flow rates, with double shut-off valve, check valve. Self-contained replaceable cartridge.

Setting pressure range: 1–6 bar.
 Max. inlet pressure: 16 bar.
 Max. working temperature: 60°C.



Code		
554040	1/2" with pressure gauge connection	1 -
554140	1/2" with pressure gauge	1 -
554150	3/4" with pressure gauge	1 -

573001

tech. broch. 01061

Automatic charging unit with **CAa type** backflow preventer and shut-off valve. Filling unit setting pressure range: 0,2–4 bar.
 Max. working pressure: 10 bar.
 Max. working temperature: 65°C.
 Backflow preventer certified to EN 14367 standard.

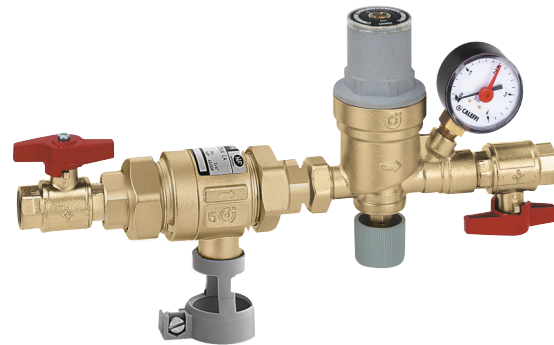

Code		
573001	1/2"	1 5

574011

tech. broch. 01161

Compact automatic charging unit with **BA type** backflow preventer, shut-off valve and strainer. **With pre-formed insulation.**
 Filling unit setting pressure range: 0,2–4 bar.
 Max. working pressure: 10 bar.
 Max. working temperature: 65°C.

Backflow preventer certified to EN 12729 standard.



Code		
574011	1/2"	1 5

574000

tech. broch. 01061

Automatic charging unit with **BA type** backflow preventer, Y-strainer and shut-off valve. Filling unit setting pressure range: 0,2–4 bar. Max. working pressure: 10 bar. Max. working temperature: 65°C. Backflow preventer certified to EN 12729 standard.



Code			
574000	1/2"	1	5

574001

tech. broch. 01125

Automatic charging unit with **BA type** backflow preventer, Y-strainer and shut-off valve. Pressure reducing valve setting pressure range: 1–6 bar. Max. working pressure: 10 bar. Max. working temperature: 60°C. Backflow preventer certified to EN 12729 standard.



Code			
574001	3/4"	1	-

NEW

580010

tech. broch. 01333

Automatic compact charging unit to EN 1717 standard with **BA type** backflow preventer, shut-off valve, strainer, pressure test ports for controlling the backflow preventer, pressure reducing valve.

For horizontal or vertical installations. dezincification resistant alloy body.

With insulation.

Filling unit setting pressure range: 0,8–4 bar.

Max. working pressure: 10 bar.

Max. working temperature: 65°C.

Backflow preventer certified to EN 12729 standard.

Pressure reducing valve certified to EN 1567 standard.



Code			
580010	1/2"	1	5

315

Flow switch with magnetically operated contacts. 230 V - 0,02 A (an appropriate relais must be used in case of higher power consumption). Max. working pressure: 6 bar. Temperature range: -15–100°C.

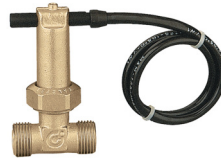

Contact closing with

increasing flow rate at: 156 l/h (1/2")
456 l/h (3/4")

Contact opening with

decreasing flow rate at: 108 l/h (1/2")
348 l/h (3/4")



Code			
315400	1/2"	1	50
315500	3/4"	1	25

626

tech. broch. 01052

Flow switch. Suitable for 1" to 8" pipes. 250 V (ac) - 15 (5) A. Max. working pressure: 10 bar. Temperature range: -30–120°C. Protection class: IP 54.

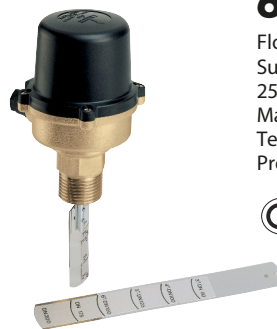

Code			
626600	1"	1	5
626009	set of blades	1	-

538

Drain cock with hose connection and cap. Max. working pressure: 10 bar. Max. working temperature: 110°C.



Code			
538201	1/4" M	1	-
538400	1/2" M	1	100



558

Automatic shut-off cock, for expansion vessels.
For domestic water circuit.
 Max. working pressure: 10 bar.
 Max. working temperature: 110°C.

Code			
558500	3/4"	1	50



558

Automatic shut-off cock, for expansion vessel, with drain cock.
For domestic water circuit.
 Max. working pressure: 6 bar.
 Max. working temperature: 85°C.

Code			
558510	3/4"	1	50



5580

Ball shut-off valve, for expansion vessels, with drain cock.
For domestic water circuit.
 Max. working pressure: 6 bar.
 Max. working temperature: 85°C.

Code			
558050	3/4"	1	20
558060	1"	1	20
558070	1 1/4"	1	20

Application diagram of shut-off valve 5580 series

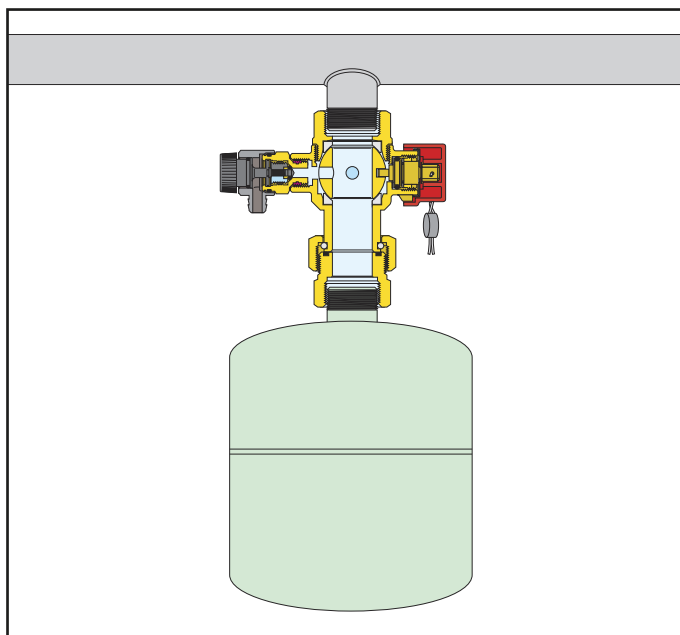

690

Three way tap for INAIL master pressure gauge.
 Max. working pressure: 15 bar.
 Temperature range: 5–90°C.

Code			
690200	1/4"	5	–
690300	3/8"	5	–
690400	1/2"	5	–



691

Water hammer reducing loop. In chrome plated copper.

Code			
691200	1/4"	5	–
691300	3/8"	5	–
691400	1/2"	5	–



692

Thermometer in sleeve. 1/2" pocket connection.

Code	Pocket length	°C		
692000	45 mm	0–120	1	–



693

Bulb thermometer.

Code	°C		
693000	0–120	1	–



694

INAIL test pocket, 1/2" connection.

Code	Pocket length		
694045	45 mm	1	–
694100	100 mm	1	–

695

System filling test pump. Complete with pressure gauge and hose for connection to the system.

Max. working pressure: 50 bar.
 Water content: 12 l.
 Pressure gauge scale: 0–60 bar.
 Hose connection: 1/2".
 Hose length: 1,5 m.

Can be used also with glycol solutions for solar thermal systems.



Code		
695000	1	–

THERMOSTATS AND PRESSURE SWITCHES



621

Adjustable contact thermostat.
Temperature range: 20–90°C.
Protection class: IP 20.



Code		
621000	1	10

625

Safety pressure switch, with manual reset.
250 V - 16 (10) A.
Max. working pressure: 5 bar.
Ambient temperature range: 0–50°C.
Medium temperature range: 20–110°C.
1/4" female connection.
Protection class: IP 44.



Code	Setting range		
625000	2–4,5 bar	1	50

622

Adjustable immersion thermostat.
Temperature range: 0–90°C.
With 1/2" connection pocket.
Protection class: IP 40.



Code		
622000	1	10

625

Minimum pressure safety switch,
with manual reset.
250 V - 16 (10) A.
Max. working pressure: 5 bar.
Ambient temperature range: 0–50°C.
Medium temperature range: 20–110°C.
1/4" female connection.
Protection class: IP 44.



Code	Setting range		
625100	0,5–1,7 bar	1	10

623

Double immersion thermostat:
- safety thermostat with manual reset,
setting 100°C (+0°C -6°C),
setting 110°C (+0°C -6°C)
- adjustment thermostat,
temperature range: 0–90°C,
temperature range: 0–100°C.
With 1/2" connection pocket.
Protection class: IP 40.



Code	Safety setting	Adjustment range		
623000	100°C	0–90°C	1	5
623100	110°C	0–100°C	1	5

625

Pressure switch for boosting sets and
domestic water applications.
Up to 500 V three-pole - 16 (10) A.
Ambient temperature range: 0–55°C.
Medium temperature range: 0–55°C.
1/4" female connection.
Protection class: IP 44.



Code	Setting range	Max. pressure		
625005	1– 5 bar	5 bar	1	10
625010	3–12 bar	12 bar	1	10

624

Immersion safety thermostat,
with manual reset,
- setting 100°C (+0°C -6°C),
- setting 110°C (+0°C -6°C).
With 1/2" connection pocket.
Protection class: IP 40.



Code	Safety setting		
624000	100°C	1	10
624100	110°C	1	10

613

Float switch,
250 V - 10 A.
Heavy duty approved.



Code	Cable length		
613030	3 m	1	5
613050	5 m	1	5



557

Pressure gauge.
Accuracy class: UNI 2,5.
Temperature range: -20-90°C.

Code	bar		Position	Ø		
557104	0-4	1/4"	central back conn.	50	1	-
557204	0-4	1/4"	"off-centred" back conn.	50	1	-
557304	0-4	1/4"	bottom conn.	50	1	-
557106	0-6	1/4"	central back conn.	50	1	-
557306	0-6	1/4"	bottom conn.	50	1	-
557310	0-10	1/4"	bottom conn.	50	1	-
557410	0-10	1/4"	central back conn.	63	1	-
557425	0-25	1/4"	central back conn.	63	1	-
557704	0-4	3/8"	bottom conn.	80	1	-
557706	0-6	3/8"	bottom conn.	80	1	-
557710	0-10	3/8"	bottom conn.	80	1	-



503

Temperature/pressure gauge.
1/2" central back connection.
With shut-off pocket.
Ø 80 mm.
Accuracy class:
- temperature gauge UNI 2;
- pressure gauge UNI 2,5.

Code	bar	°C		
503040	0-4	0-120	1	10
503060	0-6	0-120	1	10



503

Temperature/pressure gauge.
1/2" bottom connection.
With shut-off pocket.
Ø 80 mm.
Accuracy class:
- temperature gauge UNI 2;
- pressure gauge UNI 2,5.

Code	bar	°C		
503140	0-4	0-120	1	20
503160	0-6	0-120	1	20



5560

Pressure gauge
for expansion vessel pressure test.
Accuracy class: UNI 2,5.

Code	bar		
556000	0-10	1	-



688

Temperature gauge.
1/2" central back connection.
With pocket.
Ø 80 mm.
Accuracy class: UNI 2.

Code	Pocket length	°C		
688000	45 mm	0-120	1	10
688010	100 mm	0-120	1	5
688011	without pocket	0-120	1	5



688

Temperature gauge.
1/2" bottom connection.
With pocket.
Ø 80 mm.
Accuracy class: UNI 2.

Code	Pocket length	°C		
688100	45 mm	0-120	1	10



687

Temperature gauge for cooling systems.
1/2" central back connection.
With pocket.
Ø 80 mm.
Accuracy class: UNI 2.

Code	Pocket length	°C		
687000	45 mm	-30-50	1	-
687010	100 mm	-30-50	1	-



687

Temperature gauge for cooling.
1/2" bottom connection.
With pocket.
Ø 80 mm.
Accuracy class: UNI 2.

Code	Pocket length	°C		
687110	100 mm	-30-50	1	10



689

Flow gauge.
3/8" bottom connection.
Ø 80 mm.
Accuracy class: UNI 2,5.
Temperature range: -20-90°C.

Code	m w.g.		
689010	0-10	1	20
689016	0-16	1	20
689025	0-25	1	30



For higher pressures see pressure gauges 557 series.

STRAINERS



577



Y-strainer.
Bronze body,
1/2"-2": PN 16,
2 1/2" - 3": PN 10.
Female connections.
Temperature range: -20-110°C.
Max. percentage of glycol: 30%.
Strainer on stainless steel stretched plate.

Code		Mesh size Ø (mm)	Kv (m³/h)		
577004	1/2"	0,40	3,4	1	-
577005	3/4"	0,40	7	1	-
577006	1"	0,40	10	1	-
577007	1 1/4"	0,47	16	1	-
577008	1 1/2"	0,47	24	1	-
577009	2"	0,53	35	1	-
577020	2 1/2"	0,53	57	1	-
577030	3"	0,53	73	1	-

579

Y strainer for heating systems.
Grey cast iron body.
Max. working pressure: 16 bar.
Temperature range: -10-100°C.
Max. percentage of glycol: 50%.
Flanged connections PN 16.
To be coupled with flat counterflanges EN 1092-2.
Filtering mesh in stainless steel AISI 304.



Code		Mesh size Ø (mm)	Kv (m³/h)		
579051	DN 50	0,87	54	1	-
579061	DN 65	0,87	76	1	-
579081	DN 80	1,55	108	1	-
579101	DN 100	1,55	170	1	-
579121	DN 125	1,55	295	1	-
579151	DN 150	1,55*	408	1	-
579201	DN 200	1,55*	725	1	-
579251	DN 250	1,55*	938	1	-

*Rhomboidal reinforcing mesh



HYDRAULIC SEPARATORS

548

tech. broch. 01076



Hydraulic separator.
Epoxy resin coated steel body.
With pre-formed insulation.
Female union connections.
Max. working pressure: 10 bar.
Temperature range: 0–100°C.
Complete with:
air vent with automatic shut-off cock,
drain cock.

Code		Max. recommended flow rate m ³ /h		
548006	1"	2,5	1	–
548007	1 1/4"	4	1	–
548008	1 1/2"	6	1	–
548009	2"	8,5	1	–

Choice of hydraulic separator 548 series



The hydraulic separator should be sized according to the **maximum flow rate value at the inlet**. The selected design value must be the greatest between the primary circuit and the secondary circuit.

548

tech. broch. 01076



Hydraulic separator.
Epoxy resin coated steel body.
With pre-formed insulation.
Flanged connections PN 16.
To be coupled with flat counterflanges EN 1092-1.
Max. working pressure: 10 bar.
Temperature range:
0–105°C (DN 50–DN 100),
0–100°C (DN 125 - DN 150).
Temperature probe connection: 1/2" F.
Complete with:
automatic air vent, shut-off valve,
drain valve.



Code		Max. recommended flow rate m ³ /h		
548052	DN 50	9	1	–
548062	DN 65	18	1	–
548082	DN 80	28	1	–
548102	DN 100	56	1	–
548122	DN 125	75	1	–
548152	DN 150	110	1	–

548

tech. broch. 01076



Hydraulic separator.
Epoxy resin coated steel body.
Flanged connections PN 16.
To be coupled with flat counterflanges EN 1092-1.
Max. working pressure: 10 bar.
Temperature range: 0–110°C.
Temperature probe connection: 1/2" F.
Complete with:
automatic air vent, shut-off valve,
drain valve.



Code		Max. recommended flow rate m ³ /h		
548050	DN 50	9	1	–
548060	DN 65	18	1	–
548080	DN 80	28	1	–
548100	DN 100	56	1	–
548120	DN 125	75	1	–
548150	DN 150	110	1	–

548

tech. broch. 01076



Hydraulic separator.
Epoxy resin coated steel body.
Flanged connections PN 10.
To be coupled with flat counterflanges EN 1092-1.
Max. working pressure: 10 bar.
Temperature range: 0–110°C.
Temperature probe connection: 1/2" F.
Complete with:
automatic air vent, shut-off valve,
drain valve.

Code		Max. recommended flow rate m ³ /h		
548200	DN 200	180	1	–
548250	DN 250	300	1	–
548300	DN 300	420	1	–

MULTIFUNCTION HYDRAULIC SEPARATOR



5495 SEP4

tech. broch. 01249

Multifunction hydraulic separator. Epoxy resin coated steel body.

With pre-formed insulation.

Female union connections.

Max. working pressure: 10 bar.

Temperature range: 0–100°C.

Complete with:

- hydraulic separator,
- automatic air vent,
- dirt separator,
- magnetic ring,
- drain cock with hose connection.

PCT
INTERNATIONAL
APPLICATION
PENDING

Function

The multifunction hydraulic separator combines different functional components, each of them to satisfy specific needs of air conditioning system circuits.

It is supplied complete with hot pre-formed shell insulation to ensure perfect thermal insulation when used with both hot and chilled water.

The device is designed to carry out the following functions:

- Hydraulic separation

To keep connected hydraulic circuits totally independent from each other.

- Deaeration



Utilises the combined action of several physics principles: the widening of the cross section decreases the flow velocity and the technopolymer mesh creates whirling movements so as to facilitate the release of micro-bubbles. The bubbles, fusing with each other, increase in volume and, rising towards the top of the unit, are released through a float-operated automatic air vent.

- Dirt separation

The dirt separator separates and collects any impurities in the circuits as they collide with the surface of the internal element.

- Removal of magnetic particles

The special patented magnetic system also attracts ferromagnetic impurities in the water: the ferromagnetic particles are trapped in the collection zone, meaning they are prevented from being recirculated.

Code		Max. recommended flow rate m ³ /h		
549506	1"	2,5	1	-
549507	1 1/4"	4	1	-
549508	1 1/2"	6	1	-
549509	2"	8,5	1	-

Hydraulic separation

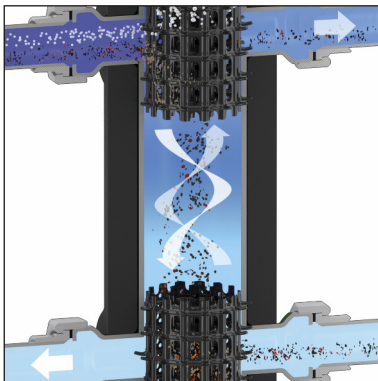

Dirt removal

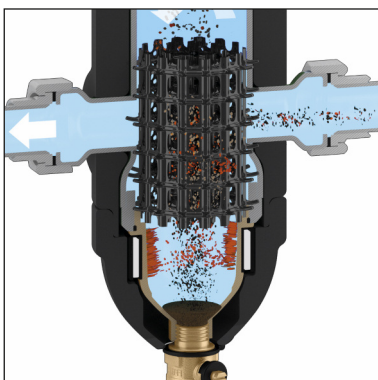

Deaeration

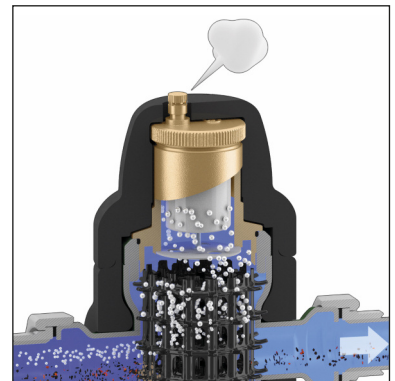

Removal of magnetic particles

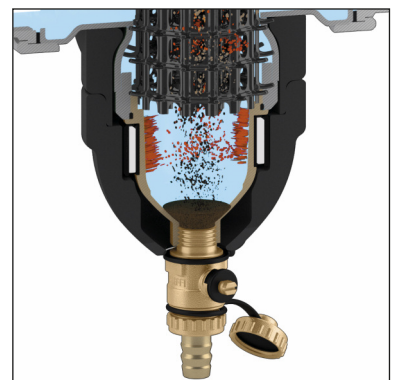

HYDRAULIC SEPARATORS-MANIFOLDS



559 SEPCOLL 2+2. tech. broch. 01084

Hydraulic separator-manifold for heating systems. Steel body, PN 6. **With pre-formed insulation.**
 1 1/4" F main connections.
 1 1/2" outlet connections with captive nut: two at the top and two at the bottom.
 Temperature range: 0–110°C.
 Complete with mounting brackets.

Code	Outlet centre distance		
559222	125 mm	1	–



559 SEPCOLL 2. tech. broch. 01084

Hydraulic separator-manifold for heating and air conditioning systems. Steel body, PN 6. **With pre-formed insulation.**
 1" F main connections.
 Outlet connections: two 1 1/2" at the top with captive nut.
 Temperature range: 0–100°C.
 Complete with mounting brackets.

Code	Outlet centre distance		
559320	125 mm	1	–



559 SEPCOLL 3+1. tech. broch. 01084

Hydraulic separator-manifold for heating systems. Steel body, PN 6. **With pre-formed insulation.**
 1 1/4" F main connections.
 1 1/2" outlet connections with captive nut: three at the top and one at the bottom (can be inverted).
 Temperature range: 0–110°C.
 Complete with mounting brackets.

Code	Outlet centre distance		
559231	125 mm	1	–



559 SEPCOLL 3+1. tech. broch. 01084

Hydraulic separator-manifold for heating and air conditioning systems. Steel body, PN 6. **With pre-formed insulation.**
 1 1/4" F main connections.
 1 1/2" outlet connections with captive nut: three at the top and one at the bottom (can be inverted).
 Temperature range: 0–100°C.
 Complete with mounting brackets.

Code	Outlet centre distance		
559331	125 mm	1	–



559 SEPCOLL 2+1. tech. broch. 01084



Hydraulic separator-manifold for heating systems. Steel body, PN 6. **With pre-formed insulation.**
 1" F main connections.
 Outlet connections: two 1 1/2" at the top with captive nut and one 1" F at the side.
 Temperature range: 0–110°C.
 Complete with mounting brackets.

Code	Outlet centre distance		
559221	125 mm	1	–

Maximum recommended flow rate at inlets of SEPCOLL separator 559 series		
Outlets	Primary	Secondary (total)
2+1 / 2	2 m ³ /h	5 m ³ /h
2+2	2,5 m ³ /h	6 m ³ /h
3+1	2,5 m ³ /h	6 m ³ /h



559 Pair of plugs with gaskets for unused outlets. For 559 and 550 series.

Code	Outlet centre distance		
559001		1	–



559 SEPCOLL 2. tech. broch. 01084

Hydraulic separator-manifold for heating systems. Steel body, PN 6. **With pre-formed insulation.**
 1" F main connections.
 Outlet connections: two 1 1/2" at the top with captive nut.
 Temperature range: 0–110°C.
 Complete with mounting brackets.



Code	Outlet centre distance		
559220	125 mm	1	–

NEW

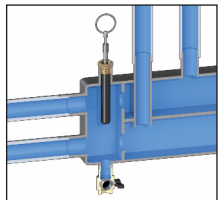

559 Pocket with magnetic insert. For 559 series.



Code	Outlet centre distance		
559003	1/2" M	1	–

MANIFOLDS FOR CENTRAL HEATING SYSTEM

550 2

tech. broch. 01261

Manifold for heating and air conditioning systems.
Steel body.
1 1/4" M main connections.
Outlet connections: 1 1/2" F with captive nut.
Max. working pressure: 10 bar.
Temperature range: 5–110°C.

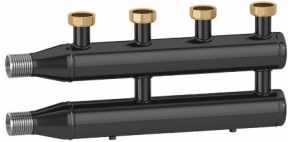

Code	Outlet centre distance		
550020	125 mm	1	–

550 2+1

tech. broch. 01261

Manifold for heating and air conditioning systems.
Steel body.
1 1/4" M main connections.
Outlet connections: 1 1/2" F with captive nut.
Max. working pressure: 10 bar.
Temperature range: 5–110°C.

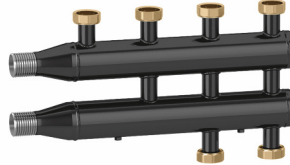

Code	Outlet centre distance		
550021	125 mm	1	–

550 3

tech. broch. 01261

Manifold for heating and air conditioning systems.
Steel body.
1 1/2" M main connections.
Outlet connections: 1 1/2" F with captive nut.
Max. working pressure: 10 bar.
Temperature range: 5–110°C.

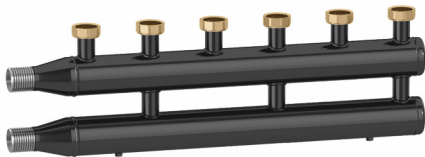

Code	Outlet centre distance		
550030	125 mm	1	–

550 3+1

tech. broch. 01261

Manifold for heating and air conditioning systems.
Steel body.
1 1/2" M main connections.
Outlet connections: 1 1/2" F with captive nut.
Max. working pressure: 10 bar.
Temperature range: 5–110°C.

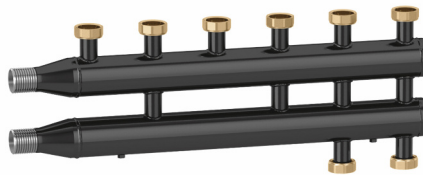

Code	Outlet centre distance		
550031	125 mm	1	–

550 4

tech. broch. 01261

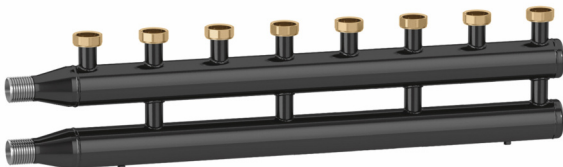

Manifold for heating and air conditioning systems.
Steel body.
1 1/2" M main connections.
Outlet connections: 1 1/2" F with captive nut.
Max. working pressure: 10 bar.
Temperature range: 5–110°C.



Code	Outlet centre distance		
550040	125 mm	1	–

Insulation for manifolds for central heating system 550 series. For heating and air conditioning systems.





Code			
CBN550020	for manifold 2	1	–
CBN550021	for manifold 2+1	1	–
CBN550030	for manifold 3	1	–
CBN550031	for manifold 3+1	1	–
CBN550040	for manifold 4	1	–

559

Pair of fittings with gaskets. For 550 and 559 series.





Code			
559002	1 1/2" M x 1" M	1	–

550

Kit for 550 series manifold pipe connection to 548 series hydraulic separator.



Code			
550001	1 1/4" x 1 1/4"	1	–
550002	1 1/2" x 1 1/4"	1	–
550003	1 1/2" x 1 1/2"	1	–
550004	2" x 1 1/2"	1	–

DIRECT SUPPLY UNITS



165

tech. broch. 01237

Direct supply unit for heating systems.
With pre-formed insulation.
 Max. working pressure: 10 bar.
 Max. working temperature: 100°C.
 Supply: 230 V - 50/60 Hz.
 System side connection: 1" F.
 Boiler side connection: 1 1/2" M.
Centre distance:
125 mm fitted for SEPCOLL.



RH to LH convertible



Code	Connection	Pump		
165600A2L	1" F	UPM3 Auto L 25-70	1	-
165601UPM	1" F	UPML 25-95	1	-



165

tech. broch. 01255

Direct supply unit for heating and air conditioning systems.
With pre-formed insulation.
 Max. working pressure: 10 bar.
 Primary inlet temperature range: 5-100°C.
 Supply: 230 V - 50/60 Hz.
 System side connection: 1" F.
 Boiler side connection: 1 1/2" M.
Centre distance:
125 mm fitted for SEPCOLL.



Upward flow - flow on RH side
 Downward flow - flow on LH side



Code	Connection	Pump		
165640WYP	1" F	YONOS PARA 25/6 RKA	1	-
165641UPM	1" F	UPML 25-95	1	-

Upward flow - flow on LH side
 Downward flow - flow on RH side



Code	Connection	Pump		
165650WYP	1" F	YONOS PARA 25/6 RKA	1	-
165651UPM	1" F	UPML 25-95	1	-

THERMOSTATIC REGULATING UNIT

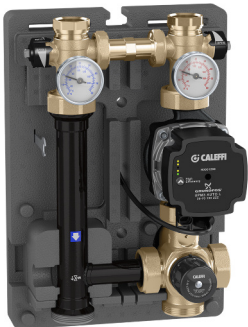

166

tech. broch. 01238

Thermostatic regulating unit for heating systems.
With pre-formed insulation.
 Max. working pressure: 10 bar.
 Max. working temperature: 100°C.
 Supply: 230 V - 50/60 Hz.
 System side connection: 1" F.
 Boiler side connection: 1 1/2" M.
Centre distance:
125 mm fitted for SEPCOLL.



RH to LH convertible



Code	Connection	Pump	Temperature adjustment range		
166600A2L	1" F	UPM3 Auto L 25-70	25-50°C	1	-
166601UPM	1" F	UPML 25-95	25-50°C	1	-
166605A2L	1" F	UPM3 Auto L 25-70	40-70°C	1	-

MOTORISED REGULATING UNITS



167

tech. broch. 01239

Motorised regulating unit for heating systems.
With pre-formed insulation.
 Regulation with sector three-way valve and 3-point actuator.
 With auxiliary microswitch.
 Can be connected to digital regulators code 161010 and 1520 series.
 Max. working pressure: 10 bar.
 Max. working temperature: 100°C.
 Supply: 230 V - 50/60 Hz.
 Operating time: 50 s (90° rotation).
 System side connection: 1" F.
 Boiler side connection: 1 1/2" M.
Centre distance:
125 mm fitted for SEPCOLL.



Upward flow - flow on RH side
 Downward flow - flow on LH side



Code	Connection	Pump		
167600A2L	1" F	UPM3 Auto L 25-70	1	-
167601UPM	1" F	UPML 25-95	1	-

Upward flow - flow on LH side
 Downward flow - flow on RH side



Code	Connection	Pump		
167610A2L	1" F	UPM3 Auto L 25-70	1	-
167611UPM	1" F	UPML 25-95	1	-



167

tech. broch. 01254

Motorised regulating unit for heating and air conditioning systems.
With pre-formed insulation.
 Regulation with sector three-way valve and 3-point actuator.
 With auxiliary microswitch.
 Can be connected to digital regulators code 161010 and 1520 series.
 Max. working pressure: 10 bar.
 Primary inlet temperature range: 5-100°C.
 Supply: 230 V - 50/60 Hz.
 Operating time: 50 s (90° rotation).
 System side connection: 1" F.
 Boiler side connection: 1 1/2" M.
Centre distance:
125 mm fitted for SEPCOLL.



Upward flow - flow on RH side
 Downward flow - flow on LH side



Code	Connection	Pump		
167640WYP	1" F	YONOS PARA 25/6 RKA	1	-
167641UPM	1" F	UPML 25-95	1	-

Upward flow - flow on LH side
 Downward flow - flow on RH side



Code	Connection	Pump		
167650WYP	1" F	YONOS PARA 25/6 RKA	1	-
167651UPM	1" F	UPML 25-95	1	-

TEMPERATURE REGULATORS

NEW



161

Digital regulator with synoptic diagram for heating and cooling complete with immersion flow probes with pocket and Pt1000 Ø 6 mm return probe. Optional outside compensated probe. Temperature adjustment range: 5–95°C. Supply: 230 V - 50/60 Hz. Protection class: IP 20 / EN 60529. Probe cable length: 1,5 m.



Code

161010



1 -

For accessories see page 107



1520

Digital temperature controller for heating and cooling. Complete with flow probe, outside probe and max. relative humidity probe. Supply: 230 V - 50/60 Hz. Power consumption: 5,5 VA. Protection class: IP 40.



Code

152021 1 channel



1 -



1520

Outside compensated digital temperature regulator. Complete with contact flow probe and outside probe. Adjustment range: 20–90°C. Supply: 230 V - 50/60 Hz. Protection class: IP 40.



Code

152001 1 channel

152002 2 channels

152003 3 channels



1 -

1 -

1 -

The diagram is just an indication

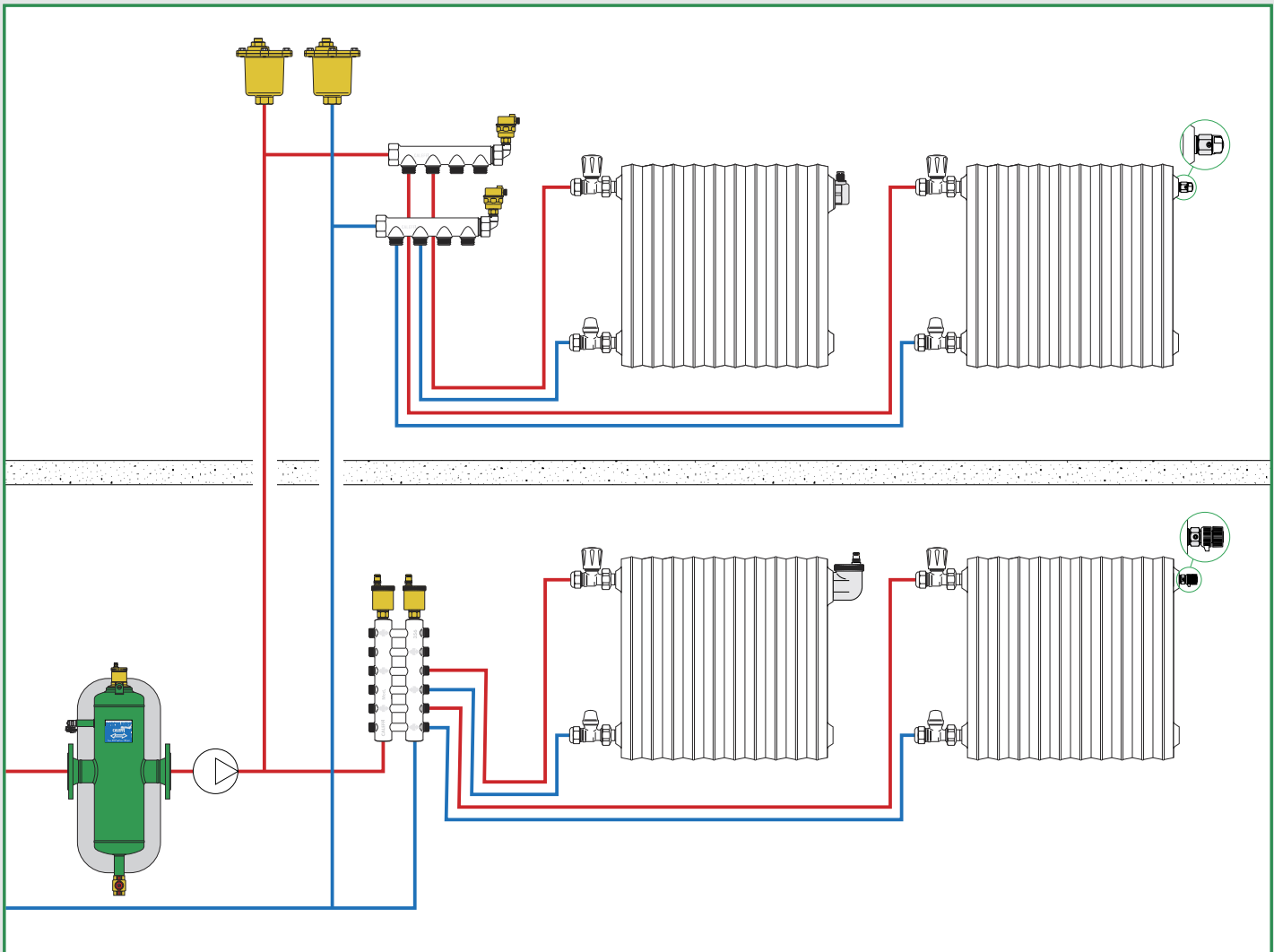

Automatic air vents

End plug for radiators with automatic air vent, AERCAL

Manual air vents

Drain cocks

Deaerators in composite, DISCALSLIM®

Deaerators, DISCAL®

Deaerators-dirt separators, DISCALDIRT®

Dirt separators, DIRTCAL®

Dirt separators with magnet, DIRTMAG®

Self-cleaning dirt separator filter with magnet, DIRTMAGCLEAN®

Manual cleaning dirt separator filter with magnet, DIRTMAGCLEAN®

Dirt separators in composite with magnet, DIRTMAG®

Multifunction device in composite with dirt separator and strainer, DIRTMAGPLUS®

Composite under-boiler dirt separators with magnet, DIRTMAGSLIM®



**501
MAXCAL**

tech. broch. 01031

Automatic air vent for heating, air conditioning and refrigeration. High discharge capacity. Brass body and cover, stainless steel internal components. Max. working pressure: 16 bar. Max. discharge pressure: 6 bar. Temperature range: -20-120°C.



Code



501500	3/4" F x 3/8" F	1	5
---------------	-----------------	---	---



**5020
MINICAL**

tech. broch. 01054

Automatic air vent. In hot-stamped brass. Chrome plated. Max. working pressure: 10 bar. Max. discharge pressure: 2,5 bar. Max. working temperature: 120°C.



Code



502031	3/8" M	10	50
502041	1/2" M	10	50



**551
DISCALAIR®**

tech. broch. 01124

High performance automatic air vent. Brass body. **Female connection.** Max. working pressure: 10 bar. Max. discharge pressure: 10 bar. Temperature range: 0-110°C.



Code



551004	1/2"	1	10
---------------	------	---	----



**5020
MINICAL**

tech. broch. 01054

Automatic air vent. In hot-stamped brass. Chrome plated. With hygroscopic safety cap. Max. working pressure: 10 bar. Max. discharge pressure: 2,5 bar. Max. working temperature: 120°C.



Code



502051	3/4" M	2	50
502061	1" M	2	50



**5020
MINICAL**

tech. broch. 01054

Automatic air vent. In hot-stamped brass. Max. working pressure: 10 bar. Max. discharge pressure: 2,5 bar. Max. working temperature: 120°C.



Code



502030	3/8" M	10	50
502040	1/2" M	10	50



**5021
MINICAL**

tech. broch. 01054

Automatic air vent. In hot-stamped brass. With automatic shut-off cock. Max. working pressure: 10 bar. Max. discharge pressure: 2,5 bar. Max. working temperature: 110°C.



Code



502130	3/8" M	10	100
502140	1/2" M	10	100



**5020
MINICAL**

tech. broch. 01054

Automatic air vent. In hot-stamped brass. With hygroscopic safety cap. Max. working pressure: 10 bar. Max. discharge pressure: 2,5 bar. Max. working temperature: 120°C.



Code



502050	3/4" M	2	50
502060	1" M	2	50



**5021
MINICAL**

tech. broch. 01054

Automatic air vent. In hot-stamped brass. Chrome plated. With automatic shut-off cock. Max. working pressure: 10 bar. Max. discharge pressure: 2,5 bar. Max. working temperature: 110°C.



Code



502131	3/8" M	10	100
502141	1/2" M	10	100



**5021
MINICAL**

tech. broch. 01054

Automatic air vent.
In hot-stamped brass.
Chrome plated.
With automatic shut-off cock and
hygroscopic safety cap.
Max. working pressure: 10 bar.
Max. discharge pressure: 2,5 bar.
Max. working temperature: 110°C.



Code			
502132	3/8" M	10	100
502142	1/2" M	10	100



**5024
ROBOCAL**

tech. broch. 01033

Automatic air vent.
In hot-stamped brass.
Max. working pressure: 10 bar.
Max. discharge pressure: 4 bar.
Max. working temperature: 115°C.



Code			
502420	1/4" M	112	-
502430	3/8" M	1	50



**5022
VALCAL**

tech. broch. 01054

Automatic air vent.
In hot-stamped brass.
Chrome plated.
Max. working pressure: 10 bar.
Max. discharge pressure: 4 bar.
Max. working temperature: 120°C.

Code			
502221	1/4" M	1	25
502231	3/8" M	1	25
502241	1/2" M	1	25



**5025
ROBOCAL**

tech. broch. 01033

Automatic air vent.
In hot-stamped brass.
With automatic shut-off cock.
Max. working pressure: 10 bar.
Max. discharge pressure: 4 bar.
Max. working temperature: 110°C.



Code			
502533	3/8" M	10	100
502543	1/2" M	10	100



561

tech. broch. 01054

Automatic shut-off cock.
For automatic air vents 502. series.
PTFE seal on thread.
Max. working pressure: 10 bar.
Max. working temperature: 110°C.

Code			
561230	1/4" x 3/8" M	50	500
561300	3/8" x 3/8" M	10	-
561340	3/8" x 1/2" M	10	-
561400	1/2" x 1/2" M without PTFE seal on thread	10	-



**5026
ROBOCAL**

tech. broch. 01033

Automatic air vent.
In hot-stamped brass.
Max. working pressure: 10 bar.
Max. discharge pressure: 6 bar.
Max. working temperature: 115°C.



Code			
502630	3/8" M	10	50
502640	1/2" M	10	100



561

tech. broch. 01054

Automatic shut-off cock.
For automatic air vents 5020 and
5022 series.
Chrome plated.
PTFE seal on thread.
Max. working pressure: 10 bar.
Max. working temperature: 110°C.

Code			
561301	3/8" x 3/8" M	10	-
561401	1/2" x 1/2" M without PTFE seal on thread	10	-



**5027
ROBOCAL**

tech. broch. 01033

Automatic air vent.
In hot-stamped brass.
With automatic shut-off cock.
Max. working pressure: 10 bar.
Max. discharge pressure: 6 bar.
Max. working temperature: 110°C.



Code			
502730	3/8" M	10	100



**507
AERCAL**

tech. broch. 01032

End plug for radiators with automatic air vent. In hot-stamped brass. Chrome plated. With hygroscopic safety cap. With rubber seal. Max. working pressure: 10 bar. Max. discharge pressure: 6 bar. Max. working temperature: 100°C.

Code			
507611	1" M right	1	25
507621	1" M left	1	25
507711	1 1/4" M right	1	25
507721	1 1/4" M left	1	25



**504
AERCAL**

tech. broch. 01055

Automatic air vent for radiators. In hot-stamped brass. Chrome plated. With hygroscopic safety cap. Max. working pressure: 10 bar. Max. discharge pressure: 2,5 bar. Max. working temperature: 100°C.

Code			
504401	1/2" M	1	25
504501	3/4" M	1	25
504611	1" M right	1	25
504621	1" M left	1	25



**R59720
AQUASTOP**

tech. broch. 01032

Hygroscopic safety cap. For end plugs 507 series. Chrome plated.

Code		
R59720	1	-



**R59681
AQUASTOP**

tech. broch. 01054

Hygroscopic safety cap. For automatic air vents 5020 and 5021 series.

Code		
R59681	1	-



**5620
AQUASTOP**

tech. broch. 01054

Hygroscopic safety cap. For automatic air vents 5020, 5021, 5022 and 504 series. Chrome plated.

Code		
562000	50	-



5621

tech. broch. 01054

Anti-vacuum cap. For automatic air vents 5020, 5021 and 5022 series.

Code		
562100	100	-



5622

tech. broch. 01033

Anti-vacuum cap. For automatic air vents 5024, 5025, 5026 and 5027 series.

Code		
562200	100	-



505

tech. broch. 01056

Manual air vent for radiators.
Chrome plated.
White POM (acetal resin) knob.
PTFE seal on thread.
Max. working pressure: 10 bar.
Max. working temperature: 90°C.

Code

505111	1/8" M	50	-
505121	1/4" M	50	500
505131	3/8" M	50	500



5055

tech. broch. 01056

Manual air vent for radiators.
Rubber seal.
Chrome plated.
White POM (acetal resin) knob.
PTFE seal on thread.
Max. working pressure: 10 bar.
Max. working temperature: 90°C.

Code

505511	1/8" M	10	100
505521	1/4" M	10	100
505531	3/8" M	10	100
505541	1/2" M	10	50

Manual air vent for radiators 5055 series

The identifying detail of this valve is an internal seal in a special elastic material which provides a tight seal in relation to limited tightening of the knob and possible temperature changes.

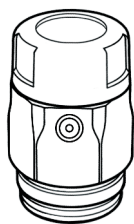
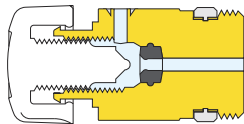

The knob of the valve is shaped so as to be similar in appearance to Caleffi thermostatic valve heads, which enhances the uniformity of the radiator component range.

For all the radiator air vents, the knob should be tightened with the system still cold.



5054

tech. broch. 01056

Manual air vent for radiators.
Chrome plated.
White POM (acetal resin) knob.
Adjustable outlet.
PTFE seal on thread.
Max. working pressure: 10 bar.
Max. working temperature: 90°C.

Code

505411	1/8" M	50	-
505421	1/4" M	50	-
505431	3/8" M	50	-
505441	1/2" M	50	-



5080

tech. broch. 01056

Automatic hygroscopic air vent for radiators. Chrome plated.
White POM (acetal resin) knob.
PTFE seal on thread.
Max. working pressure: 10 bar.
Max. working temperature: 100°C.

Code

508011	1/8" M	25	-
508021	1/4" M	25	-
508031	3/8" M	25	-
508041	1/2" M	25	-



5081

tech. broch. 01056

Spare hygroscopic cartridge for 5080 series.

Code

508100	12 p.1,5	25	-
--------	----------	----	---



337

Drain cock.
Adjustable outlet.
PTFE seal on thread.
Max. working pressure: 6 bar.
Max. working temperature: 85°C.
Medium: water, glycol solutions.
Max. percentage of glycol: 30%.



Code

337121	1/4"	50	200
337131	3/8"	50	200



337

Drain cock with metal seal.
Adjustable outlet.
PTFE seal on thread.
Max. working pressure: 10 bar.
Max. working temperature: 100°C.



Code

337221	1/4"	80	400
337231	3/8"	50	250



560

tech. broch. 01056

Drain cock for radiators and wall-mounted boilers.
Chrome plated.
Max. working pressure: 10 bar.
Max. working temperature: 100°C.

Code

560421	1/2"	10	-
560000	extractor drain hose	25	-

◆ One extractor drain hose code 560000 is included in each 10-item package

DEAERATORS

NEW



551 DISCALSLIM®

tech. broch. 01337

Deaerator. Technopolymer body.
Female connections.
Adjustable for horizontal and vertical pipes.
 With hygroscopic safety cap.
 Max. working pressure: 3 bar.
 Max. working temperature: 110°C.
 PATENT PENDING.

Code

551805	3/4" F	1	10
551806	1" F	1	10

NEW



551 DISCALSLIM®

tech. broch. 01337

Deaerator. Technopolymer body.
Ø 18 and Ø 22 mm with compression ends.
Adjustable for horizontal and vertical pipes.
 With hygroscopic safety cap.
 Max. working pressure: 3 bar.
 Max. working temperature: 110°C.
 PATENT PENDING.

Code

551801	Ø 18	1	10
551802	Ø 22	1	10

NEW



Insulation for deaerators
 DISCALSLIM® 551 series.

Code

CBN551805		1	-
------------------	--	---	---

Operating principle

Thanks to its special internal configuration, DISCALSLIM® has a very low pressure drop.

The internal shape deviates a part of flow in the deaeration chamber. In the above mentioned chamber the flow slows down and is subdivided by the fins present in secondary chambers which cause appropriate turbulences. Thanks to these mini-vortices, the micro bubbles of air present in the flow are separated, collected in the lower part of the chamber, and after aggregating into larger bubbles, they rise upwards through the drain ducts located aside the float.

Once the top of the valve is reached, the aggregate bubbles push the float downwards, causing the air vent to open and therefore to discharge the air.

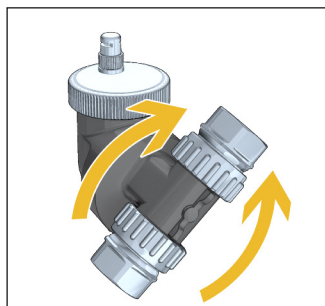
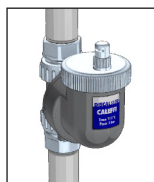
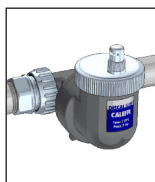
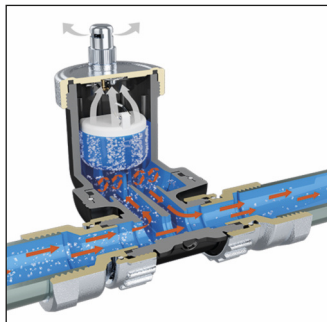

551 DISCAL®

tech. broch. 01060

Deaerator. Brass body.
Female and male connections and Ø 22 and Ø 28 mm with compression ends.
Adjustable for horizontal and vertical pipes.
 Max. working pressure: 10 bar.
 Max. discharge pressure: 10 bar.
 Temperature range: 0-110°C.



Code

551705	3/4" F	1	-
551706	1" F	1	-
551716	1" M	1	-
551702	Ø 22	1	-
551703	Ø 28	1	-



551 DISCAL®

tech. broch. 01060

Deaerator. Brass body.
Female connections and Ø 22 mm with compression ends.
 Max. working pressure: 10 bar.
 Max. discharge pressure: 10 bar.
 Temperature range: 0-110°C.



Code

551003	3/4" F	1	10
551002	Ø 22	1	10



551 DISCAL®

tech. broch. 01060

Deaerator. Brass body.
Female connections. With drain.
 Max. working pressure: 10 bar.
 Max. discharge pressure: 10 bar.
 Temperature range: 0-110°C.



Code

551005	3/4" F	1	6
551006	1" F	1	6
551007	1 1/4" F	1	6
551008	1 1/2" F	1	6
551009	2" F	1	-



Insulation for deaerators
 DISCAL® 551 series.

Code

Use

CBN551005	551005-551006	1	-
CBN551007	551007-551008	1	-
CBN551009	551009	1	-

DEAERATORS





551 DISCAL®

tech. broch. 01060

Deaerator.
Epoxy resin coated steel body.
Flanged connections PN 16.
To be coupled with flat counterflanges EN 1092-1.
With insulation.
Max. working pressure: 10 bar.
Max. discharge pressure: 10 bar.
Temperature range:
0–105°C (DN 50–DN 100),
0–100°C (DN 125–DN 150),
0–110°C (without insulation).

Code

Code	DN			
551052	DN 50		1	–
551062	DN 65		1	–
551082	DN 80		1	–
551102	DN 100		1	–
551122	DN 125		1	–
551152	DN 150		1	–
551050	DN 50	without insulation	1	–
551060	DN 65	without insulation	1	–
551080	DN 80	without insulation	1	–
551100	DN 100	without insulation	1	–
551120	DN 125	without insulation	1	–
551150	DN 150	without insulation	1	–





551 DISCAL®

tech. broch. 01060

Deaerator.
Epoxy resin coated steel body.
Flanged connections PN 10.
To be coupled with flat counterflanges EN 1092-1.
Max. working pressure: 10 bar.
Max. discharge pressure: 10 bar.
Temperature range:
0–110°C.
Temperature probe connection: 1/2" F.

Code

Code	DN			
551200	DN 200		1	–
551250	DN 250		1	–
551300	DN 300		1	–





551 DISCAL®

tech. broch. 01060

Deaerator.
Epoxy resin coated steel body.
Weld ends.
With insulation.
Max. working pressure: 10 bar.
Max. discharge pressure: 10 bar.
Temperature range:
0–105°C (DN 50–DN 100),
0–100°C (DN 125–DN 150),
0–110°C (without insulation).

Code

Code	DN			
551053	DN 50		1	–
551063	DN 65		1	–
551083	DN 80		1	–
551103	DN 100		1	–
551123	DN 125		1	–
551153	DN 150		1	–
551051	DN 50	without insulation	1	–
551061	DN 65	without insulation	1	–
551081	DN 80	without insulation	1	–
551101	DN 100	without insulation	1	–
551121	DN 125	without insulation	1	–
551151	DN 150	without insulation	1	–

DEAERATORS-DIRT SEPARATORS



546
DISCALDIRT®

tech. broch. 01123

Deaerator-dirt separator.
Brass body.
Female connections and Ø 22 mm with compression ends.
Drain cock with hose connection.
Max. working pressure: 10 bar.
Max. discharge pressure: 10 bar.
Temperature range: 0–110°C.
Particle separation rating down to 5 µm.



Code			
546005	3/4"	1	–
546006	1"	1	–
546007	1 1/4"	1	–
546002	Ø 22	1	–



5461
DISCALDIRTMAG

tech. broch. 01123

Deaerator-dirt separator **with magnet**.
Brass body.
Female connections.
Drain cock with hose connection.
Max. working pressure: 10 bar.
Max. discharge pressure: 10 bar.
Temperature range: 0–110°C.
Particle separation rating down to 5 µm.



Code			
546105	3/4"	1	–
546106	1"	1	–
546107	1 1/4"	1	–



Insulation
for deaerators-dirt separators 546 series.

Code	Use		
CBN546002	546002-546005-546006	1	–
CBN546007	546007	1	–



5461
DISCALDIRTMAG

tech. broch. 01123

Deaerator-dirt separator **with magnet**.
Epoxy resin coated steel body.
Female union connections.
With insulation.
Drain cock with hose connection.
Max. working pressure: 10 bar.
Max. discharge pressure: 10 bar.
Temperature range: 0–100°C.
Particle separation rating down to 5 µm.



Code			
546118	1 1/2"	1	–
546119	2"	1	–

Operating principle

The deaerator-dirt separator uses the combined action of several physical principles. The active part consists of an assembly of concentric metal mesh surfaces. These elements create the whirling movement required to facilitate the release of micro-bubbles and their adhesion to these surfaces. The bubbles, fusing with each other, increase in volume until the hydrostatic thrust is such as to overcome the adhesion force to the structure. They rise towards the top of the unit from which they are released through a float-operated automatic air release valve. The impurities in the water, colliding with the metal surfaces of the internal element, are separated out and fall to the bottom of the valve body.

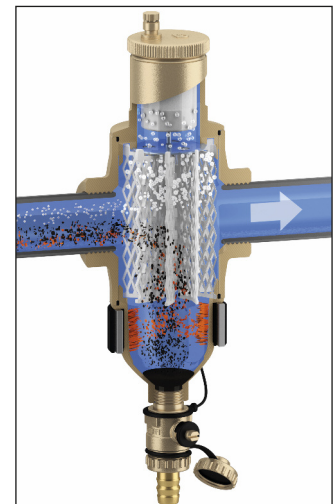
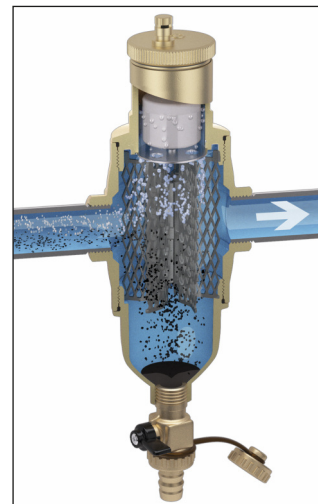



DEAERATORS-DIRT SEPARATORS



546 DISCALDIRT®

tech. broch. 01123

Deaerator-dirt separator.
Epoxy resin coated steel body.
Weld ends.
With insulation.
Max. working pressure: 10 bar.
Max. discharge pressure: 10 bar.
Temperature range:
0–105°C (DN 50–DN 100),
0–100°C (DN 125–DN 150),
0–110°C (without insulation).
Particle separation rating
down to 5 µm.

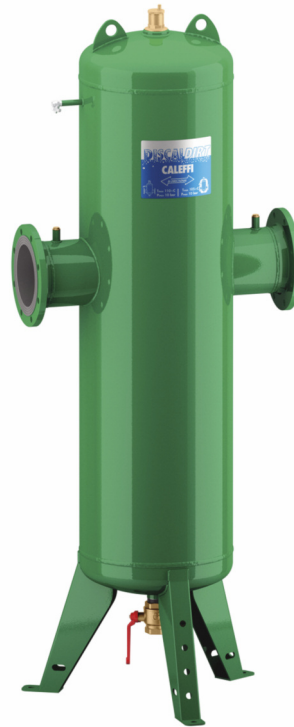

Code				
546053	DN 50		1	–
546063	DN 65		1	–
546083	DN 80		1	–
546103	DN 100		1	–
546123	DN 125		1	–
546153	DN 150		1	–
546051	DN 50	without insulation	1	–
546061	DN 65	without insulation	1	–
546081	DN 80	without insulation	1	–
546101	DN 100	without insulation	1	–
546121	DN 125	without insulation	1	–
546151	DN 150	without insulation	1	–



546 DISCALDIRT®

tech. broch. 01123

Deaerator-dirt separator.
Epoxy resin coated steel body.
Flanged connections PN 10.
To be coupled with flat
counterflanges EN 1092-1.
Max. working pressure: 10 bar.
Max. discharge pressure: 10 bar.
Temperature range: 0–110°C.
Temperature probe connection: 1/2" F.
Particle separation rating
down to 5 µm.



Code				
546200	DN 200		1	–
546250	DN 250		1	–
546300	DN 300		1	–



546 DISCALDIRT®

tech. broch. 01123

Deaerator-dirt separator.
Epoxy resin coated steel body.
Flanged connections PN 16.
To be coupled with flat
counterflanges EN 1092-1.
With insulation.
Max. working pressure: 10 bar.
Max. discharge pressure: 10 bar.
Temperature range:
0–105°C (DN 50–DN 100),
0–100°C (DN 125–DN 150),
0–110°C (without insulation).
Particle separation rating
down to 5 µm.

Code				
546052	DN 50		1	–
546062	DN 65		1	–
546082	DN 80		1	–
546102	DN 100		1	–
546122	DN 125		1	–
546152	DN 150		1	–
546050	DN 50	without insulation	1	–
546060	DN 65	without insulation	1	–
546080	DN 80	without insulation	1	–
546100	DN 100	without insulation	1	–
546120	DN 125	without insulation	1	–
546150	DN 150	without insulation	1	–

DIRT SEPARATORS



5462 DIRTICAL®

tech. broch. 01137



Dirt separator. Brass body.
Female connections.
 Drain cock with hose connection.
 Top connection with plug.
 Max. working pressure: 10 bar.
 Temperature range: 0–110°C.
 Particle separation rating down to 5 µm.

Operating principle

The separating action performed by the dirt separator is based on using the internal element with reticular surfaces in place of the ordinary filter. The screen, by its nature, offers little resistance to the flow of medium while ensuring separation.

This occurs due to the particles colliding with the reticular surfaces and then settling, and not by filtration; an action by which the filter, over time, gets progressively clogged by the sludge it removes.



Code			
546205	3/4"	1	6
546206	1"	1	6
546207	1 1/4"	1	6
546208	1 1/2"	1	6
546209	2"	1	6



Insulation for dirt separators 5462 and 5463 series.



Particle separation rating - Dirt separator efficiency

The Caleffi DIRTICAL® and DIRTMAG® dirt separators, thanks to the special design of its internal element, are able to completely separate the impurities in the circuit down to a minimum particle size of 5 µm.

Following tests carried out at a specialized laboratory (TNO - Science and Industry - NL) it was found that the DIRTICAL® dirt separator (5462, 5463 and 5466 series) is able to quickly separate nearly all the impurities after only 50 recirculations, approximately one day of operation.

They are effectively removed from the circuit for particles of diameter greater than 100 µm and on average up to 80% taking account of the smallest particles.

The continual passing of the medium during normal operation of the system gradually leads to complete dirt removal.

Code	Use		
CBN546205	546205-546306-546305-546306	1	–
CBN546207	546207-546308-546307-546308	1	–
CBN546209	546209-546309	1	–

DIRT SEPARATORS WITH MAGNET



5463 DIRTMAG®

tech. broch. 01137

Dirt separator **with magnet**.
Brass body.
Female connections.
Drain cock with hose connection.
Top connection with plug.
With insulation.
Max. working pressure: 10 bar.
Temperature range: 0–110°C.
Particle separation rating down to 5 µm.



PCT INTERNATIONAL APPLICATION PENDING

Code			
546315	3/4"	1	–
546316	1"	1	8
546317	1 1/4"	1	–
546318	1 1/2"	1	–
546319	2"	1	–
546305	3/4" without insulation	1	6
546306	1" without insulation	1	6
546307	1 1/4" without insulation	1	5
546308	1 1/2" without insulation	1	5
546309	2" without insulation	1	5



5466 DIRTMAG®

tech. broch. 01137

Dirt separator **with magnet**.
Epoxy resin coated steel body.
Flanged connections PN 16.
To be coupled with flat counterflanges EN 1092-1.
With insulation.
Max. working pressure: 10 bar.
Temperature range: 0–100°C.
Temperature probe connection: 1/2" F.
Particle separation rating down to 5 µm.

Code			
546650	DN 50	1	–
546660	DN 65	1	–
546680	DN 80	1	–
546610	DN 100	1	–
546612	DN 125	1	–
546615	DN 150	1	–



5468 DIRTMAG®

tech. broch. 01137

Dirt separator **with magnet** for vertical pipes.
Brass body.
Female connections and Ø 22 and Ø 28 mm with compression ends.
Drain cock with hose connection.
Max. working pressure: 10 bar.
Temperature range: 0–110°C.



PCT INTERNATIONAL APPLICATION PENDING

Code			
546805	3/4"	1	5
546806	1"	1	5
546802	Ø 22	1	5
546803	Ø 28	1	5



5466 DIRTMAG®

tech. broch. 01137

Dirt separator **with magnet**.
Epoxy resin coated steel body.
Flanged connections PN 10.
To be coupled with flat counterflanges EN 1092-1.
Max. working pressure: 10 bar.
Temperature range: 0–100°C.
Temperature probe connection: 1/2" F.
Particle separation rating down to 5 µm.

Code			
546620	DN 200	1	–
546625	DN 250	1	–
546630	DN 300	1	–

Operating principle

The magnetic dirt separator, in addition to the traditional dirt separation function, is equipped with a patented device to collect ferrous impurities contained within the system water. For the threaded version a specific ring, featuring two slots for housing the magnets, is placed outside the body in the part for collecting the impurities while, for the flanged version, the magnet is inserted in a specific pocket positioned inside the body, extractable for cleaning from magnetic dirt particles. The ferrous particles are trapped in this way in the collection zone, thus avoiding they return in circulation.

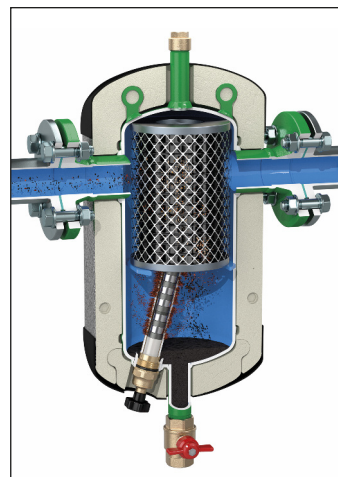
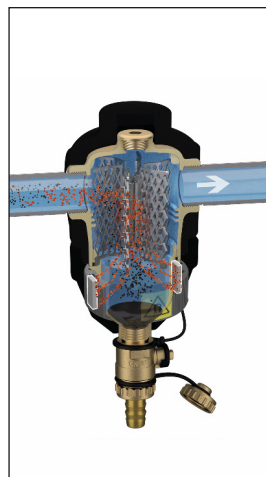

SELF-CLEANING DIRT SEPARATOR FILTER WITH MAGNET

NEW

5790
DIRTMAGCLEAN®

Self-cleaning dirt separator filter with magnet.
Body and support feet in stainless steel AISI 304.
Connections: inlet 2" M with union,
outlet 2" F,
drain 1" M with union,
flushing 1" F.

Max working pressure: 10 bar.
Temperature range: 0-85°C.
Supply: 230 V.
Particle separation rating down to 2 µm.
Fitted for inserting chemical additives.
Fitted for MODBUS-RTU management.
PATENT PENDING.

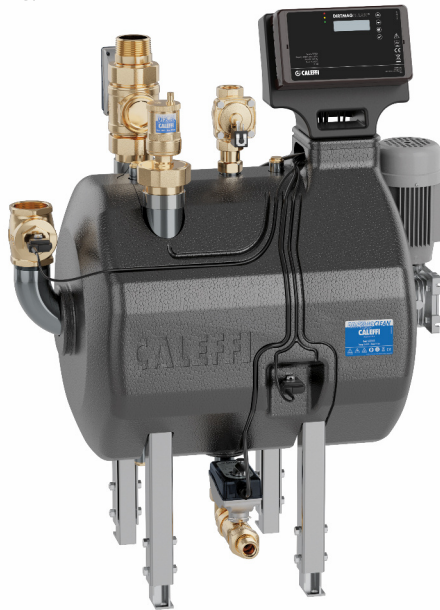

Operating principle

The device is used in heating systems controllers to remove dirt and impurities from the circuit progressively and completely. This prevents potential functional faults from occurring in the components and the flow rate regulation valves on the terminals.

The device operates through the continuous action of special filtering elements, located in a chamber through which the system water flows. The extremely fine filter mesh progressively blocks particles down to 2 µm in diameter. At the same time, ferrous particles are separated out by the magnets on the surface of the filter element. Pressure drops are kept to a minimum due to the large area of the filter mesh.

Automatic cleaning of the filtering elements takes place mechanically by means of washing with pressurised mains water while the filtering elements rotate. In all its functional phases - operation, cleaning, filling and draining - the device is controlled by a special digital regulator, which can also be managed remotely using a BMS system running MODBUS-RTU protocol.

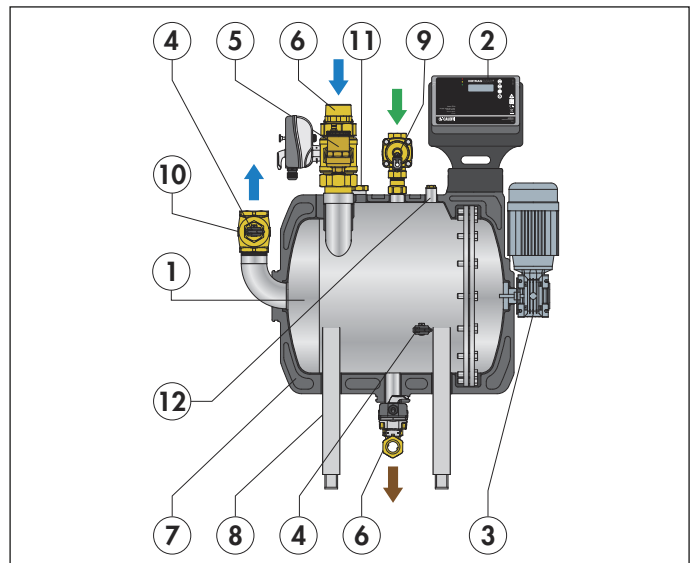

Characteristics components

- 1) Filter unit with magnet
- 2) Controller
- 3) Motorised self-cleaning unit
- 4) Pressure and temperature sensors
- 5) Air vent
- 6) Automatic motorised valves
- 7) Insulation
- 8) Adjustable support feet
- 9) Solenoid valve
- 10) Check valve
- 11) Vacuum breaker
- 12) Cap for additives addition

Code	Kv (m³/h)		
579000	45	1	-

Application diagrams

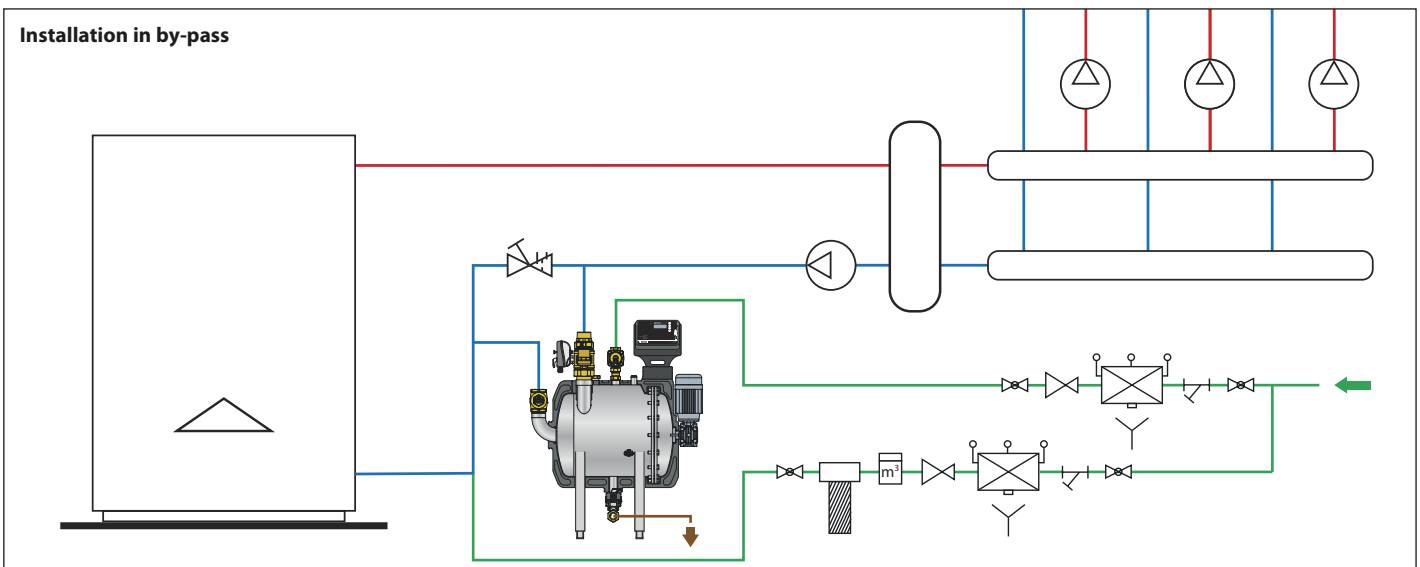

MANUAL CLEANING DIRT SEPARATOR FILTER WITH MAGNET

NEW

5790
DIRTMAGCLEAN®

Manual cleaning dirt separator filter with magnet.
Body and support feet in stainless steel AISI 304.
Connections: inlet 2" F,
outlet 2" F,
drain 1" M with union,
flushing 1" F.
Max working pressure: 10 bar.
Temperature range: 0-85°C.
Particle separation rating down to 2 µm.
PATENT PENDING.

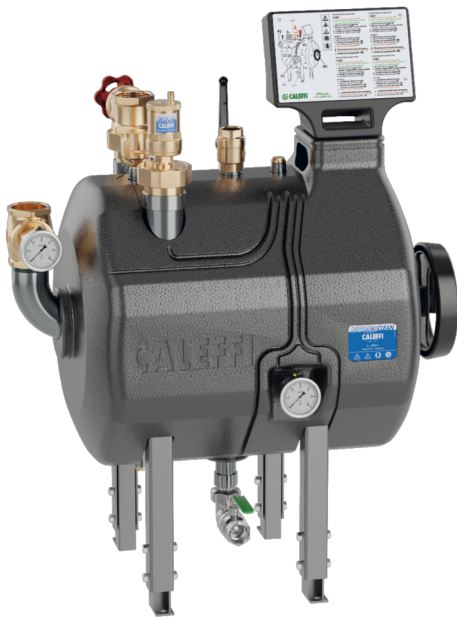

Operating principle

The device allows the removal of dirt and impurities from central heating system controllers. In the same way as its motorised version code 579000, this manual version code 579001 works by means of the continuous action of special filtering elements located in a chamber, blocking particles up to 2 µm. Ferrous particles are separated out by the special magnets on the surface of the filter element.
Periodic cleaning takes place after the heating circuit has been shut off, by means of high-pressure nozzles, while the corresponding knob is used to carry out the necessary rotation. The medium containing the impurities is then drained and normal operation is restored.
As there are no electrical connections, the device is easy to install while maintaining the same filtering efficiency as the motorised version of the same product.

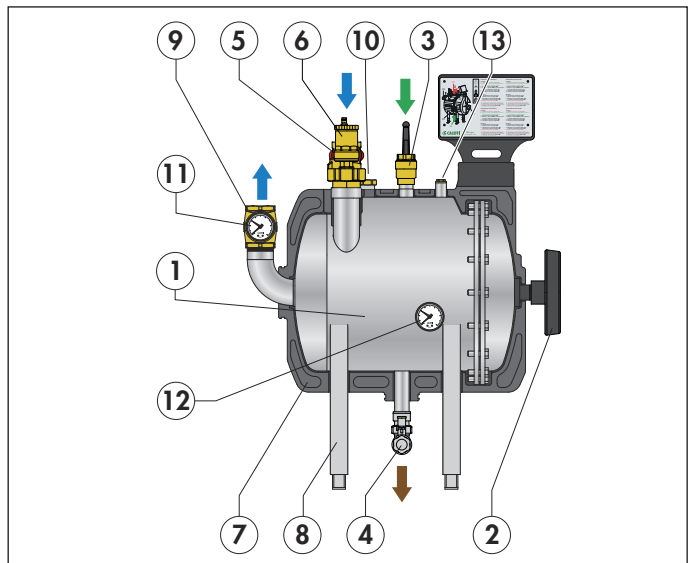

Code	Kv (m³/h)		
579001	45	1	-

Characteristics components

- 1) Filter unit with magnet
- 2) Handwheel for manual cleaning
- 3) Inlet valve for cleaning with nozzles
- 4) Drain valve
- 5) Inlet ball valve
- 6) Automatic air vent with built-in filter
- 7) Insulation
- 8) Adjustable support feet
- 9) Swing check valve
- 10) Vacuum breaker
- 11) System pressure gauge
- 12) Filter pressure gauge
- 13) Cap for additives addition

Application diagrams

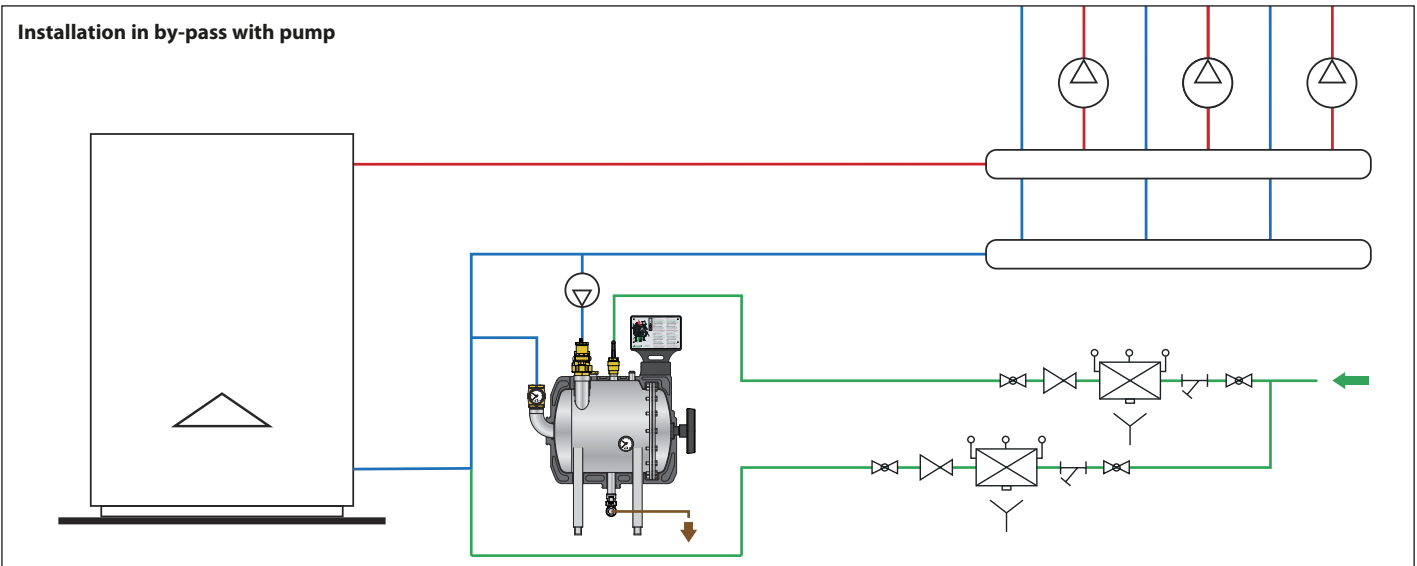

DIRT SEPARATORS IN COMPOSITE WITH MAGNET



5453 DIRTMAG®

tech. broch. 01240

Dirt separator **with magnet**.
Technopolymer body.
Female connections and Ø 22 and Ø 28 mm with compression ends.
Adjustable for horizontal and vertical pipes.
Drain cock with hose connection.
Max. working pressure: 3 bar.
Temperature range: 0–90°C.



Code

545305	3/4"	1	5
545306	1"	1	5
545302	Ø 22	1	5
545303	Ø 28	1	5



Insulation for dirt separators 5453 series.

Code

CBN545305		1	-
------------------	--	---	---



5453 DIRTMAG®

tech. broch. 01240

Dirt separator with shut-off valves **and magnet**.
Technopolymer body.
Female connections.
Adjustable for horizontal, vertical or 45° pipes.
Drain cock with hose connection.
Max. working pressure: 3 bar.
Temperature range: 0–90°C.



Code

545345	3/4"	1	5
545346	1"	1	5
545347	1 1/4"	1	5

Insulation for dirt separators codes 54534..

Code

CBN545345		1	-
------------------	--	---	---



Maintenance kit

Consisting of:
- dirt separator with shut-off valves **and magnet**;
- C3 CLEANER;
- C1 INHIBITOR.



Code

KIT545345	with dirt separator 3/4"	1	-
KIT545346	with dirt separator 1"	1	-

NEW



5709

C3 CLEANER.
Removes dirt, limescale and debris.
Dose: 0,5 litres of product every 150 litres of water in the system.

Code

570911	0,5 litres	1	12
---------------	------------	---	----

NEW



5709

C1 INHIBITOR.
Protects against corrosion and deposits.
Dose: 0,5 litres of product every 150 litres of water in the system.

Code

570912	0,5 litres	1	12
---------------	------------	---	----

Additives dosing

The dirt separator can be used as an access point to inject chemical additives into the circuit for the cleaning and the protection of the system.

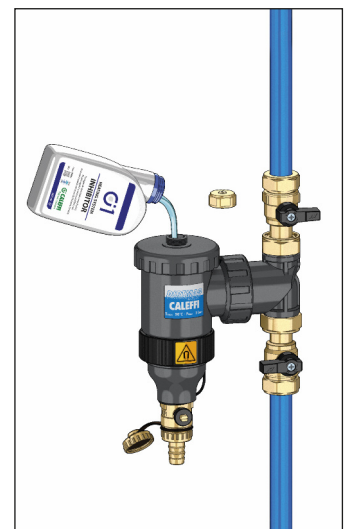
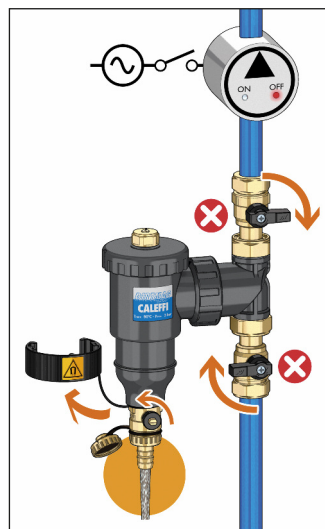

MULTIFUNCTION DEVICE IN COMPOSITE WITH DIRT SEPARATOR AND STRAINER



5453
DIRTMAGPLUS®

tech. broch. 01258

Multifunction device with dirt separator and strainer. Specific for the complete cleaning of the hydraulic circuit, to protect continuously generator and components.

Technopolymer body. Dirt separator with tecnopolimer internal element, **with magnet.**

Two inspectable strainers with stainless steel mesh: 1 for initial cleaning (blue colour) already installed, 1 for maintenance (grey colour) in package. Shut-off valves with nuts, brass body.

Female connections and Ø 22 and Ø 28 mm with compression ends.

Adjustable for horizontal, vertical or 45° pipes.

Drain cock with hose connection. Max. working pressure: 3 bar. Temperature range: 0–90°C.

PCT
INTERNATIONAL
APPLICATION
PENDING

Code			
545375	3/4"	1	5
545376	1"	1	5
545372	Ø 22	1	5
545373	Ø 28	1	5

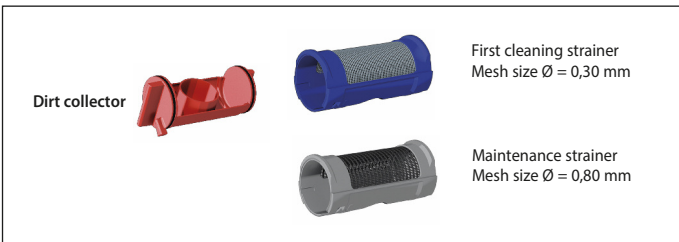

Dirt collector

First cleaning strainer
Mesh size Ø = 0,30 mm

Maintenance strainer
Mesh size Ø = 0,80 mm



Accessory kit for circuit filling and flushing and strainer accessories for device DIRTMAGPLUS® 5453 series.

Code			
F49476	accessory kit	1	10
F49474/BL	first cleaning strainer (blue colour)	1	10
F49474/GR	maintenance strainer (grey colour)	1	10

Operating principle

The multifunction device is obtained by coupling a dirt separator and a cartridge strainer arranged in series.

The water circulating in the system flows, in sequence, first through the dirt separator and then through the cartridge strainer. The dirt separator separates the impurities contained in the water by means of the action of the internal element.

Ferrous impurities are also trapped inside the body of the device thanks to the action of the two magnets inserted in a special removable outer ring.

The first passage through the dirt separator makes it possible to separate a high percentage of the impurities in the circulating water, down to minimal particle sizes.

The cartridge strainer separates impurities by means of mechanical selection of the particles in accordance with their size, by means of a special metal mesh.

All the particles with diameter bigger than the mesh size are automatically stopped and separated, **with maximum separation efficiency at the first passage.**

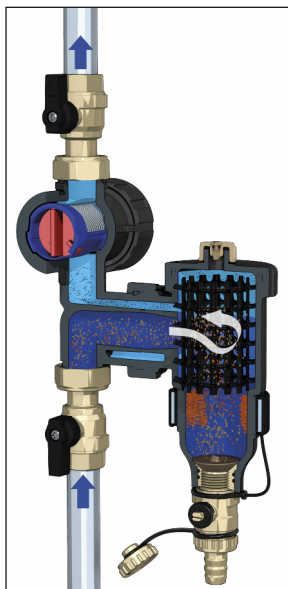

Additives dosing

The multifunction device can also be used as an access point to inject into the circuit chemical additives designed to protect the system.



Circuit cleaning and maintenance

The strainer (blue colour) downstream of the dirt separator and fitted with a specific strainer mesh is able to intercept all particles remaining in circulation, thereby ensuring optimal initial cleaning of the pipe, to protect generator and system components. The strainer is available also with a second cartridge (grey colour) fitted with a filtering mesh of bigger passage cross-section, which can be used **during maintenance phase after the first cleaning.**

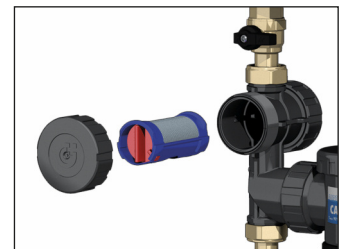

Cartridge strainer

The high-capacity strainer cartridge consists of two parts: an outer body with stainless steel mesh and a specially shaped internal element for collecting impurities.

The complete collection of impurities is always optimal, whether the installation is vertical, horizontal or 45°.

Accessory kit for circuit filling and flushing

A specific accessory kit (F49476), composed of a plug with a drain cock and an internal element for flow separation (black colour), allows the connection to an external machine for system flushing.

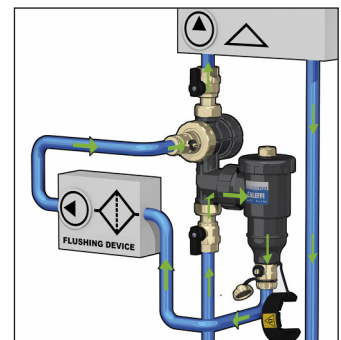
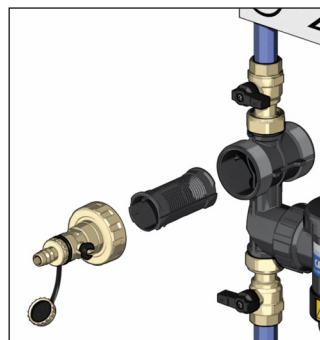

COMPOSITE UNDER-BOILER DIRT SEPARATORS WITH MAGNET



5451
DIRTMAGSLIM®

tech. broch. 01327

Dirt separator **with magnet** for under-boiler installation. Technopolymer body. Drain cock with hose connection. Fitting for wall connection: 3/4" M. Fitting for connection pipe: 3/4" F. Max. working pressure: 3 bar. Temperature range: 0-90°C.

PCT
INTERNATIONAL
APPLICATION
PENDING



Code

545105 3/4" M x 3/4" F

1 6

Installation
of code 545105

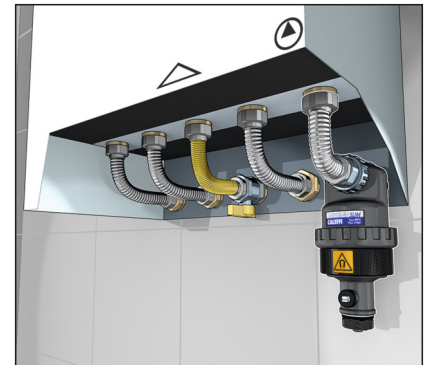

5451
DIRTMAGSLIM®

tech. broch. 01327

Dirt separator **with magnet** for under-boiler installation. Technopolymer body. Drain cock with hose connection. Fitting for wall connection: 3/4" M. Fitting for copper pipe Ø 18 mm and Ø 22 mm. Max. working pressure: 3 bar. Temperature range: 0-90°C.

PCT
INTERNATIONAL
APPLICATION
PENDING



Code

545101 3/4" M - Ø 18

1 6

545102 3/4" M - Ø 22

1 6

Installation
of code 545101

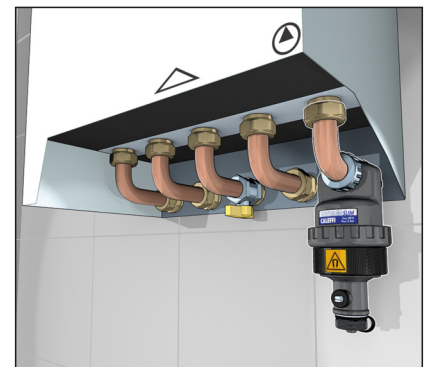

5451
DIRTMAGSLIM®

tech. broch. 01327

Dirt separator **with magnet** for under-boiler installation. Suitable for non-linear installations. Technopolymer body. Drain cock with hose connection. Fitting for wall connection: 3/4" M. Fitting for flexible pipe: 3/4" F. Max. working pressure: 3 bar. Temperature range: 0-90°C.

PCT
INTERNATIONAL
APPLICATION
PENDING



Code

545135 3/4" M x 3/4" F captive nut

1 -

Installation
of code 545135

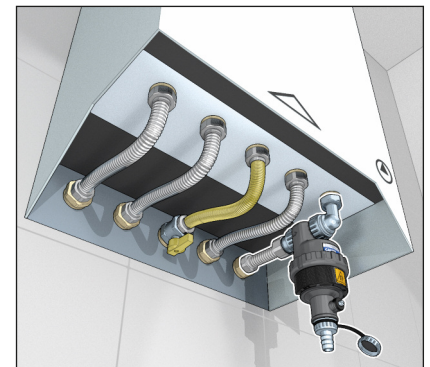

5451
DIRTMAGSLIM®

tech. broch. 01327

Dirt separator **with magnet** for under-boiler installation. Suitable for non-linear installations. Technopolymer body. Drain cock with hose connection. Fitting for wall connection: 3/4" M. Fitting for flexible pipe: 3/4" F. Max. working pressure: 3 bar. Temperature range: 0-90°C.

PCT
INTERNATIONAL
APPLICATION
PENDING



Code

545155 3/4" M x 3/4" F captive nut

1 -

Installation
of code 545155

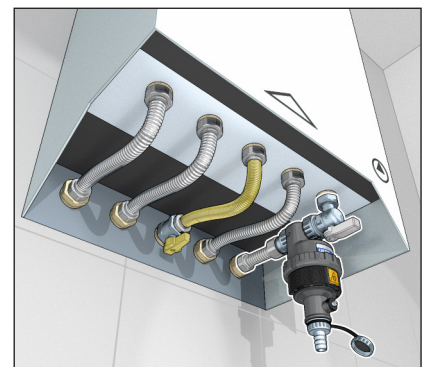

VALVES AND ACCESSORIES FOR RADIATORS

This diagram is just an indication

3

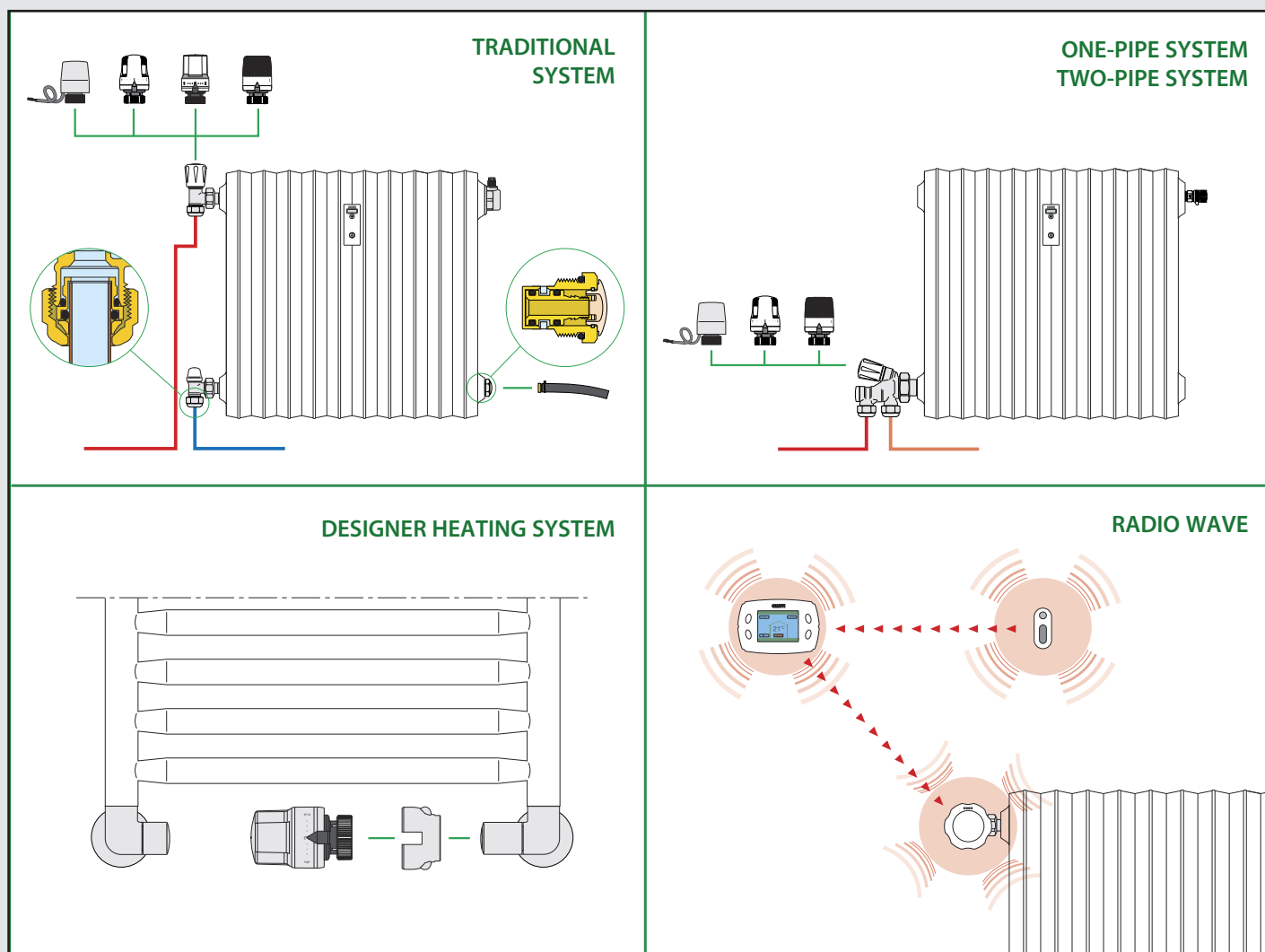

- Convertible radiator and lockshield valves
- Convertible radiator valves with pre-setting
- Convertible radiator valves for designer heating systems
- Dynamic thermostatic radiator valves
- Thermostatic radiator valves
- Double-angled thermostatic radiator and lockshield valves
- Thermostatic control heads
- Thermo-electric actuators
- Electronic thermal control system for radiators
- Manual radiator and lockshield valves
- One-pipe and two-pipe radiator valves
- Wall-covering plates
- Drain cock
- Fittings
- Calibrator for multilayer pipes
- Valves for panel radiators

CONVERTIBLE RADIATOR AND LOCKSHIELD VALVES



338

tech. broch. 01009

Angled convertible radiator valve fitted for thermostatic control heads and thermo-electric actuators. Chrome plated. For copper, single and multilayer plastic pipes. Max. working pressure: 10 bar. Temperature range: 5–100°C.

Code	Radiator connection	Pipe connection	Kv (m ³ /h)		
338302	3/8"	23 p.1,5	2,22	10	50
338402	1/2"	23 p.1,5	2,70	10	50
338452	1/2"	3/4"	2,70	10	50



342

tech. broch. 01009

Angled lockshield valve. Chrome plated. For copper, single and multilayer plastic pipes. Max. working pressure: 10 bar. Temperature range: 5–100°C.

Code	Radiator connection	Pipe connection	Kv (m ³ /h) fully open		
342302	3/8"	23 p.1,5	2,42	10	50
342402	1/2"	23 p.1,5	3,99	10	50
342452	1/2"	3/4"	3,99	10	50



339

tech. broch. 01009

Straight convertible radiator valve fitted for thermostatic control heads and thermo-electric actuators. Chrome plated. For copper, single and multilayer plastic pipes. Max. working pressure: 10 bar. Temperature range: 5–100°C.

Code	Radiator connection	Pipe connection	Kv (m ³ /h)		
339302	3/8"	23 p.1,5	1,35	10	50
339402	1/2"	23 p.1,5	1,79	10	50
339452	1/2"	3/4"	1,79	10	50



343

tech. broch. 01009

Straight lockshield valve. Chrome plated. For copper, single and multilayer plastic pipes. Max. working pressure: 10 bar. Temperature range: 5–100°C.

Code	Radiator connection	Pipe connection	Kv (m ³ /h) fully open		
343302	3/8"	23 p.1,5	1,32	10	50
343402	1/2"	23 p.1,5	2,17	10	50
343452	1/2"	3/4"	2,17	10	50



401

tech. broch. 01009

Angled convertible radiator valve fitted for thermostatic control heads and thermo-electric actuators. Chrome plated. For steel pipe. Max. working pressure: 10 bar. Temperature range: 5–100°C.

Code	Radiator connection	Kv (m ³ /h)		
401302	3/8"	2,22	10	50
401402	1/2"	2,70	10	50
401500	3/4" without rubber seal	3,36	5	25
401603	1" without rubber seal	4,47	5	25



431

tech. broch. 01009

Angled lockshield valve. Chrome plated. For steel pipe. Max. working pressure: 10 bar. Temperature range: 5–100°C.

Code	Radiator connection	Kv (m ³ /h) fully open		
431302	3/8"	2,42	10	50
431402	1/2"	3,99	10	50
431503	3/4" without rubber seal	4,52	5	25
431603	1" without rubber seal	5,64	5	25



402

tech. broch. 01009

Straight convertible radiator valve fitted for thermostatic control heads and thermo-electric actuators. Chrome plated. For steel pipe. Max. working pressure: 10 bar. Temperature range: 5–100°C.

Code	Radiator connection	Kv (m ³ /h)		
402302	3/8"	1,35	10	50
402402	1/2"	1,79	10	50
402500	3/4" without rubber seal	2,58	5	25
402603	1" without rubber seal	4,43	5	25



432

tech. broch. 01009

Straight lockshield valve. Chrome plated. For steel pipe. Max. working pressure: 10 bar. Temperature range: 5–100°C.

Code	Radiator connection	Kv (m ³ /h) fully open		
432302	3/8"	1,32	10	50
432402	1/2"	2,17	10	50
432503	3/4" without rubber seal	2,58	5	25
432603	1" without rubber seal	4,81	5	25

CONVERTIBLE RADIATOR VALVES WITH PRE-SETTING



425

tech. broch. 01195

Angled convertible radiator valve fitted for thermostatic control heads and thermo-electric actuators.

With pre-setting.

Chrome plated.

For copper, single and multilayer plastic pipes.

Max. working pressure: 10 bar.

Temperature range: 5–100°C.

Code	Radiator connection	Pipe connection		
425302	3/8"	23 p.1,5	1	50
425402	1/2"	23 p.1,5	1	50



426

tech. broch. 01195

Straight convertible radiator valve fitted for thermostatic control heads and thermo-electric actuators.

With pre-setting.

Chrome plated.

For copper, single and multilayer plastic pipes.

Max. working pressure: 10 bar.

Temperature range: 5–100°C.

Code	Radiator connection	Pipe connection		
426302	3/8"	23 p.1,5	1	50
426402	1/2"	23 p.1,5	1	50



421

tech. broch. 01195

Angled convertible radiator valve fitted for thermostatic control heads and thermo-electric actuators.

With pre-setting.

Chrome plated.

For steel pipe.

Max. working pressure: 10 bar.

Temperature range: 5–100°C.

Code	Radiator connection			
421302	3/8"		1	50
421402	1/2"		1	50
421500	3/4"	without rubber seal	1	25



422

tech. broch. 01195

Straight convertible radiator valve fitted for thermostatic control heads and thermo-electric actuators.

With pre-setting.

Chrome plated.

For steel pipe.

Max. working pressure: 10 bar.

Temperature range: 5–100°C.

Code	Radiator connection			
422302	3/8"		1	50
422402	1/2"		1	50
422500	3/4"	without rubber seal	1	25

Pre-setting device

The convertible radiator valves are equipped with an internal device for pre-setting the head loss hydraulic characteristics.

Specific passage cross sections can be selected by means of the control nut, in order to generate the required resistance to the motion of the medium.

Each passage cross section determines a specific Kv value for the creation of the head loss, which corresponds to a setting position on a graduated scale.

Depending on the position in the system, the valve can be pre-set so as to obtain an immediate balancing of the hydraulic circuit, valid for both manual and thermostatic operation.

Pre-setting operation

Remove the valve knob.

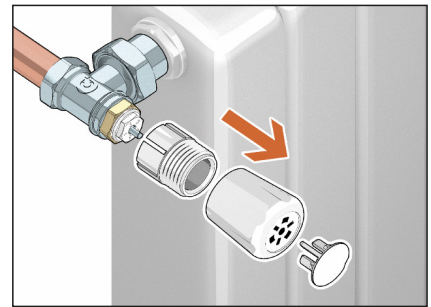

Lift the special control ring nut (supplied in package) of the pre-setting device and turn the control stem to select the required position on the graduated scale.

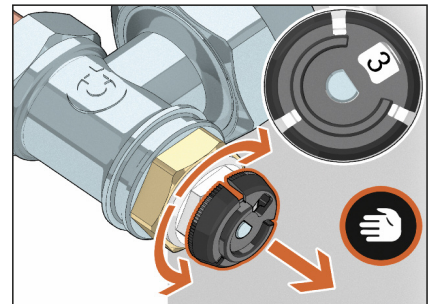

Lower the ring nut again.

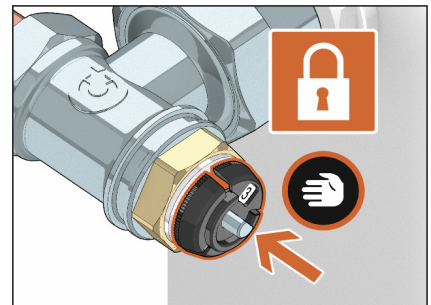

Position the manual knob, thermostatic control head or thermo-electric actuator on the valve.

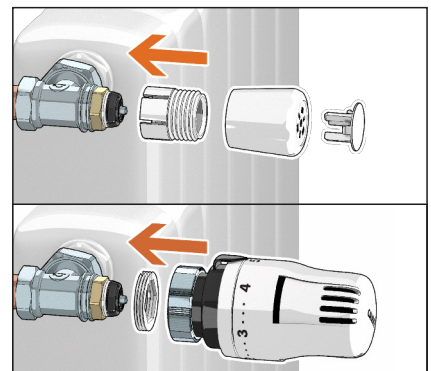

HIGH-STYLE CONVERTIBLE RADIATOR VALVES FOR DESIGNER HEATING SYSTEMS

4001

tech. broch. 01140

- Pair consisting of:
- angled-convertible radiator valve fitted for thermostatic control head code 200015;
 - angled lockshield valve;
 - two pipe-covering/wall-covering shells and allen key.

To be used with fittings 437, 447, 681 and 679 series.

High chrome finish.

Max. working pressure: 10 bar.
Temperature range: 5–100°C.



Code	Radiator connection	Pipe connection	Kv (m³/h) valve	Kv (m³/h) lockshield valve (f.o.)		
400100	1/2"	23 p.1,5	2,0	1,92	1	5

4003

tech. broch. 01140

- Pair consisting of:
- double-angled convertible radiator valve fitted for thermostatic control head code 200015;
 - lockshield valve, double-angled connections;
 - two pipe-covering/wall-covering shells and allen key.

Right-hand version.

To be used with fittings 437, 447, 681 and 679 series.

High chrome finish.

Max. working pressure: 10 bar.
Temperature range: 5–100°C.



Code	Radiator connection	Pipe connection	Kv (m³/h) valve	Kv (m³/h) lockshield valve (f.o.)		
400300	1/2"	23 p.1,5	1,27	1,37	1	5

4004

tech. broch. 01140

- Pair consisting of:
- double-angled convertible radiator valve fitted for thermostatic control head code 200015;
 - lockshield valve, double-angled connections;
 - two pipe-covering/wall-covering shells and allen key.

Left-hand version.

To be used with fittings 437, 447, 681 and 679 series.

High chrome finish.

Max. working pressure: 10 bar.
Temperature range: 5–100°C.



Code	Radiator connection	Pipe connection	Kv (m³/h) valve	Kv (m³/h) lockshield valve (f.o.)		
400400	1/2"	23 p.1,5	1,27	1,37	1	5

200

tech. broch. 01140

Thermostatic control head for designer heating system valves. Built-in sensor with liquid-filled element. For valves 4001, 4003, 4004 and 3380 series.

High chrome finish.

Graduated scale from * to 5 corresponding to a temperature adjustment range from 7°C to 28°C. With adapter, tamper-proof cap and special key for tamper-proof cap.



Code

200015



1 5

200

tech. broch. 01140

Thermostatic control head for designer heating system valves. Built-in sensor with liquid-filled element. For valves 4001, 4003, 4004 and 3380 series.

High chrome finish.

Graduated scale from * to 5 corresponding to a temperature adjustment range from 7°C to 28°C. With adapter.



Code

200013



1 10

209

tech. broch. 01140

Tamper-proof anti-theft cap for use in public places. For thermostatic control heads 200 series.

High chrome finish.

To be used with special allen key code 209001.



Code

209004



1 10

209

tech. broch. 01140

Special allen key for tamper-proof anti-theft cap. To be used with tamperproof cap 209 series.



Code

209001



1 10

Example of HIGH-STYLE valve installation for designer heating systems, right-hand version, with thermostatic control head

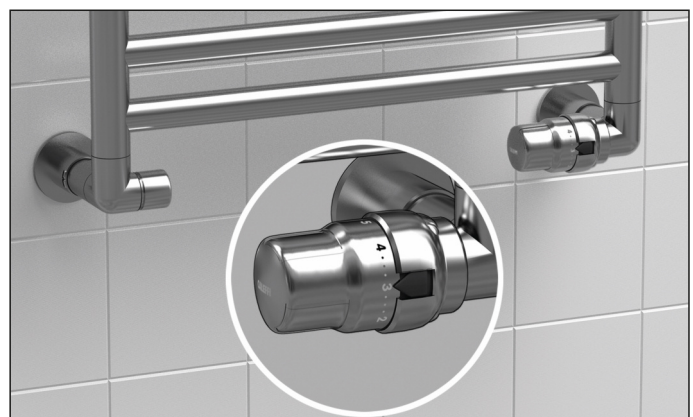

HIGH-STYLE CONVERTIBLE RADIATOR VALVES FOR DESIGNER HEATING SYSTEMS

4003

tech. broch. 01140

Pair consisting of:

- double-angled convertible radiator valve fitted for thermostatic control head code 200015;
- lockshield valve, double-angled connections;
- pipe-covering/wall-covering shell, connections: 50 mm centre distance.



Central connections.

Right-hand version.

To be used with fittings 437, 447, 681 and 679 series.



High chrome finish.
Max. working pressure: 10 bar.
Temperature range: 5–100°C.

Code	Radiator connection	Pipe connection	Kv (m ³ /h) valve	Kv (m ³ /h) lockshield valve (f.o.)		
400310	1/2"	23 p.1,5	1,27	1,37	1	5

4004

tech. broch. 01140

Pair consisting of:

- double-angled convertible radiator valve fitted for thermostatic control head code 200015;
- lockshield valve, double-angled connections;
- pipe-covering/wall-covering shell, connections: 50 mm centre distance.



Central connections.

Left-hand version.

To be used with fittings 437, 447, 681 and 679 series.



High chrome finish.
Max. working pressure: 10 bar.
Temperature range: 5–100°C.

Code	Radiator connection	Pipe connection	Kv (m ³ /h) valve	Kv (m ³ /h) lockshield valve (f.o.)		
400410	1/2"	23 p.1,5	1,27	1,37	1	5

Example of HIGH-STYLE valve installation for designer heating systems with central connection, left-hand version, with thermostatic control head

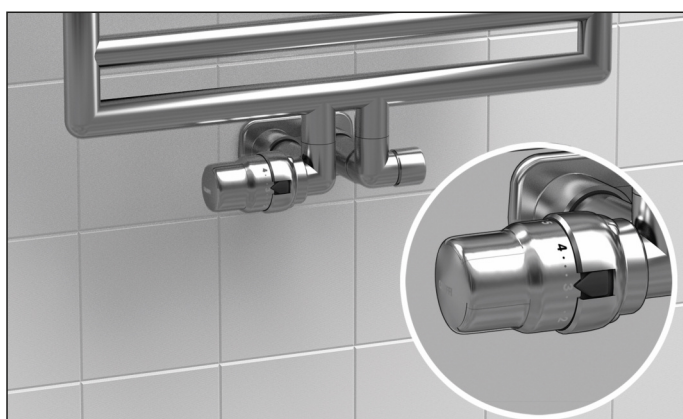

CONVERTIBLE RADIATOR VALVES FOR DESIGNER HEATING SYSTEMS



3380

Pair consisting of:

- convertible radiator valve fitted for thermo-electric actuators and thermostatic control heads;
- lockshield valve.





Angled connections.
High chrome finish.
Max. working pressure: 10 bar.
Temperature range: 5–100°C.

Code	Radiator connection	Pipe connection	Kv (m ³ /h) valve	Kv (m ³ /h) lockshield valve (f.o.)		
338040	1/2" M	23 p.1,5	2,70	3,99	1	5

437

Compression fitting, for annealed copper, hard copper, brass, mild and stainless steel pipes. With O-Ring seal. **High chrome finish.**
Max. working pressure: 10 bar.
Temperature range : -25–120°C.





Code			
437112	23 p.1,5 - Ø 12	1	50
437114	23 p.1,5 - Ø 14	1	50

681 DARCAL

Self-adjustable diameter fitting for single and multilayer plastic pipes. **High chrome finish.**
Max. working pressure: 10 bar.
Temperature range:
5–80°C (PE-X)
5–75°C (Multilayer marked 95°C).





Code		Ø _{inside}	Ø _{outside}		
681101	23 p.1,5	9,5–10	12–14	1	50
681124	23 p.1,5	11,5–12	14–16	1	50

383

Fitting for conversion from copper to steel connection.



Code			
383231	23 p.1,5 F x 3/8" F	1	10
383241	23 p.1,5 F x 1/2" F	1	10

HIGH-STYLE CONVERTIBLE RADIATOR VALVES FOR DESIGNER HEATING SYSTEMS

4001

tech. broch. 01140

- Pair consisting of:
 - angled convertible radiator valve fitted for thermostatic control head **205 series**;
 - angled lockshield valve;
 - two pipe-covering/wall-covering shells and allen key.

To be used with fittings 437, 447, 681 and 679 series.

White finish.

Max. working pressure: 10 bar.
Temperature range: 5–100°C.



Code	Radiator connection	Pipe connection	Kv (m³/h) valve	Kv (m³/h) lockshield valve (f.o.)		
400101	1/2"	23 p.1,5	2,0	1,92	1	5

4003

tech. broch. 01140

- Pair consisting of:
 - double-angled convertible radiator valve fitted for thermostatic control head **205 series**;
 - lockshield valve, double-angled connections;
 - two pipe-covering/wall-covering shells and allen key.

Right-hand version.

To be used with fittings 437, 447, 681 and 679 series.

White finish.

Max. working pressure: 10 bar.
Temperature range: 5–100°C.



Code	Radiator connection	Pipe connection	Kv (m³/h) valve	Kv (m³/h) lockshield valve (f.o.)		
400301	1/2"	23 p.1,5	1,27	1,37	1	5

4004

tech. broch. 01140

- Pair consisting of:
 - double-angled convertible radiator valve fitted for thermostatic control head **205 series**;
 - lockshield valve, double-angled connections;
 - two pipe-covering/wall-covering shells and allen key.

Left-hand version.

To be used with fittings 437, 447, 681 and 679 series.

White finish.

Max. working pressure: 10 bar.
Temperature range: 5–100°C.



Code	Radiator connection	Pipe connection	Kv (m³/h) valve	Kv (m³/h) lockshield valve (f.o.)		
400401	1/2"	23 p.1,5	1,27	1,37	1	5

205

tech. broch. 01140

Thermostatic control head for designer heating system valves. Built-in sensor with liquid-filled element. For valves 4001, 4003 and 4004 series.

White finish.

Graduated scale from * to 5 corresponding to a temperature adjustment range from 7°C to 28°C. With adapter, tamper-proof cap and special key for tamper-proof cap.



Code

205005



205

tech. broch. 01140

Thermostatic control head for designer heating system valves. Built-in sensor with liquid-filled element. For valves 4001, 4003 and 4004 series.

White finish.

Graduated scale from * to 5 corresponding to a temperature adjustment range from 7°C to 28°C. With adapter.



Code

205000

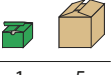

209

tech. broch. 01140

Tamper-proof anti-theft cap for use in public places. For thermostatic control heads 200, 204, 202 and 205 series.

To be used with special allen key code 209001.



Code

209000

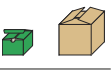

209

tech. broch. 01140

Special allen key for tamper-proof anti-theft cap. To be used with tamperproof cap 209 series.



Code

209001



Example of HIGH-STYLE valve installation for designer heating systems, right-hand version, with thermostatic control head

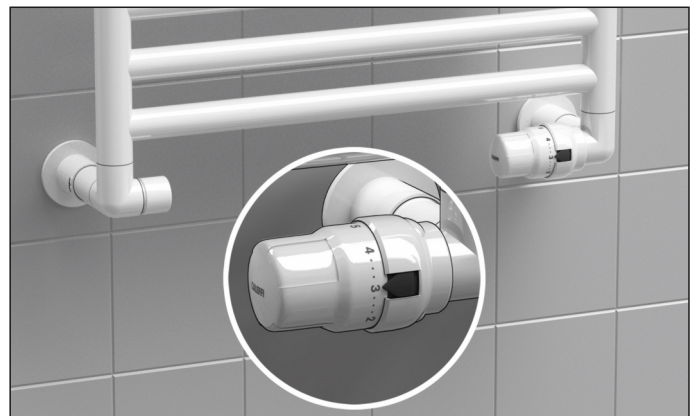

HIGH-STYLE CONVERTIBLE RADIATOR VALVES FOR DESIGNER HEATING SYSTEMS

4003

tech. broch. 01140

Pair consisting of:

- double-angled convertible radiator valve fitted for thermostatic control head **205 series**;
- lockshield valve, double-angled connections;
- pipe-covering/wall-covering shell, connections: 50 mm centre distance.

Central connections.
Right-hand version.

To be used with fittings 437, 447, 681 and 679 series.

White finish.
Max. working pressure: 10 bar.
Temperature range: 5–100°C.



Code	Radiator connection	Pipe connection	Kv (m ³ /h) valve	Kv (m ³ /h) lockshield valve (f.o.)		
400311	1/2"	23 p.1,5	1,27	1,37	1	5

4004

tech. broch. 01140

Pair consisting of:

- double-angled convertible radiator valve fitted for thermostatic control head **205 series**;
- lockshield valve, double-angled connections;
- pipe-covering/wall-covering shell, connections: 50 mm centre distance.

Central connections.
Left-hand version.

To be used with fittings 437, 447, 681 and 679 series.

White finish.
Max. working pressure: 10 bar.
Temperature range: 5–100°C.



Code	Radiator connection	Pipe connection	Kv (m ³ /h) valve	Kv (m ³ /h) lockshield valve (f.o.)		
400411	1/2"	23 p.1,5	1,27	1,37	1	5

Example of HIGH-STYLE valve installation for designer heating systems with central connection, left-hand version, with thermostatic control head

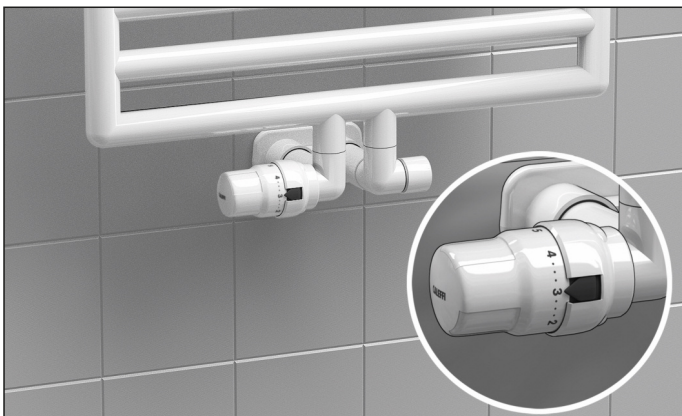

CONVERTIBLE RADIATOR AND LOCKSHIELD VALVES WITH PUSH FIT CONNECTION

338



Angled convertible radiator valve fitted for thermostatic control head and thermo-electric actuators. Chrome plated. Push fit connection for Ø 15 hard and annealed copper pipes or for extension code 936415. Max. working pressure: 10 bar. Temperature range: 5–100°C.

Code	Radiator connection	Pipe connection	Kv (m ³ /h)		
338415	1/2"	Ø 15	2,70	1	50

342



Angled lockshield valve. Chrome plated. Push fit connection for Ø 15 hard and annealed copper pipes or for extension code 936415. Max. working pressure: 10 bar. Temperature range: 5–100°C.

Code	Radiator connection	Pipe connection	Kv (m ³ /h) fully open		
342415	1/2"	Ø 15	3,99	1	50

936



Extension for convertible radiator valves with push fit connection to wall connection fitting. In polished stainless steel. With shaped rubber seal. Length: 100 mm (useful 88 mm).

Code	Radiator connection	Pipe connection	Kv (m ³ /h) fully open		
936415	1/2" x Ø 15			1	10

Installation of the valve on the pipe and locking with suitable clamps

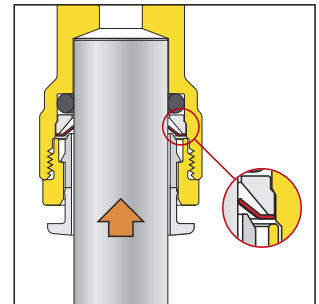
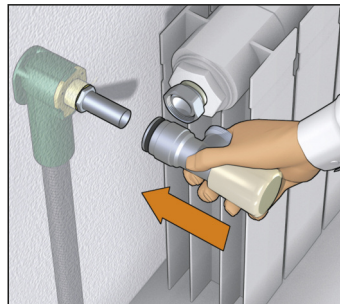

Release by pressing on the outer ring

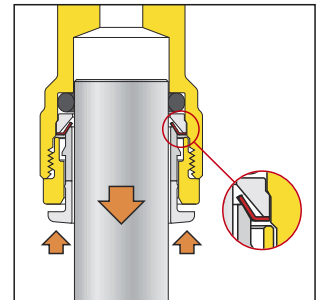
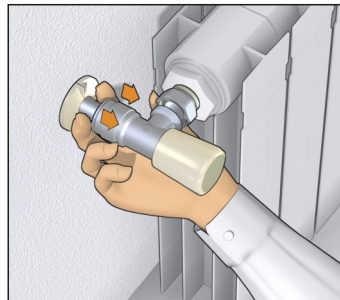

DYNAMIC THERMOSTATIC RADIATOR VALVES

NEW



230 DYNAMICAL®

tech. broch. 01330

Angled dynamic thermostatic radiator valve fitted for thermostatic and electronic control heads, thermo-electric actuators. Chrome plated. For steel pipe. Max. working pressure: 10 bar. Temperature range: 5–95°C.

PCT
INTERNATIONAL APPLICATION PENDING

Code			
230302	3/8"	10	50
230402	1/2"	10	50
230500	3/4" without rubber seal	5	25



234 DYNAMICAL®

tech. broch. 01330

Reverse dynamic thermostatic radiator valve fitted for thermostatic and electronic control heads, thermo-electric actuators. Chrome plated. For steel pipe. Max. working pressure: 10 bar. Temperature range: 5–95°C.

PCT
INTERNATIONAL APPLICATION PENDING

Code			
234302	3/8"	5	25
234402	1/2"	5	25



231 DYNAMICAL®

tech. broch. 01330

Straight dynamic thermostatic radiator valve fitted for thermostatic and electronic control heads, thermo-electric actuators. Chrome plated. For steel pipe. Max. working pressure: 10 bar. Temperature range: 5–95°C.

PCT
INTERNATIONAL APPLICATION PENDING

Code			
231302	3/8"	10	50
231402	1/2"	10	50
231500	3/4" without rubber seal	5	25



237 DYNAMICAL®

tech. broch. 01330

Reverse dynamic thermostatic radiator valve fitted for thermostatic and electronic control heads, thermo-electric actuators. Chrome plated. For copper, single and multilayer plastic pipes. Max. working pressure: 10 bar. Temperature range: 5–95°C.

PCT
INTERNATIONAL APPLICATION PENDING

Code	Radiator connection	Pipe connection		
237302	3/8"	23 p.1,5	5	25
237402	1/2"	23 p.1,5	5	25



232 DYNAMICAL®

tech. broch. 01330

Angled thermostatic radiator valve fitted for thermostatic and electronic control heads, thermo-electric actuators. Chrome plated. For copper, single and multilayer plastic pipes. Max. working pressure: 10 bar. Temperature range: 5–95°C.

PCT
INTERNATIONAL APPLICATION PENDING

Code	Radiator connection	Pipe connection		
232302	3/8"	23 p.1,5	10	50
232402	1/2"	23 p.1,5	10	50



233 DYNAMICAL®

tech. broch. 01330

Straight dynamic thermostatic radiator valve fitted for thermostatic and electronic control heads, thermo-electric actuators. Chrome plated. For copper, single and multilayer plastic pipes. Max. working pressure: 10 bar. Temperature range: 5–95°C.

PCT
INTERNATIONAL APPLICATION PENDING

Code	Radiator connection	Pipe connection		
233302	3/8"	23 p.1,5	10	50
233402	1/2"	23 p.1,5	10	50

DYNAMIC THERMOSTATIC RADIATOR VALVES

NEW

Pre-setting operation

Remove the valve knob.

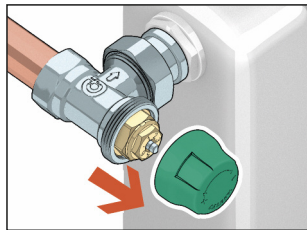

To pre-set the flow rate, place the specific shaped ring. The setting position reference is determined by the orientation of the flat lateral surface (1) of the control stem.

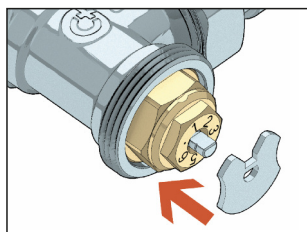

Rotate the control stem to select the desired position.

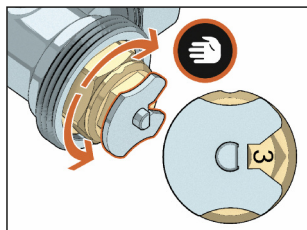

Remove the setting nut and place the thermostatic control head on the valve.

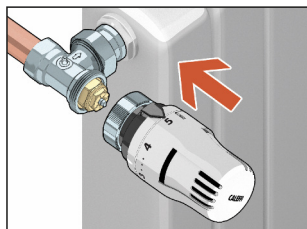

Measurement of working Δp

To measure the working Δp of the valves, it is available a special instrument and accessories.

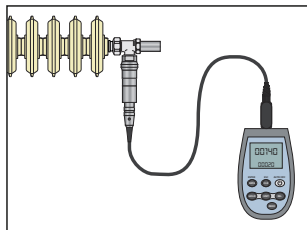

Function

The DYNAMICAL® valve allows dynamic system balancing and a regulation of the thermal medium independent from the pressure within the radiators of two-pipe heating systems. The device, in conjunction with a thermostatic control head, combines different functions in a single component.

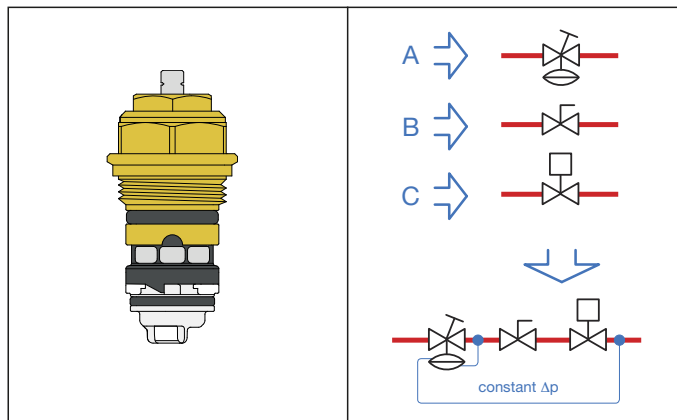

- A. **The differential pressure regulator** automatically cancels the effect of pressure fluctuation characterising variable flow rate systems and prevents noisy functioning.
- B. **The flow rate pre-setting device** makes it possible to directly set the maximum flow rate value, thanks to the combination with the differential pressure regulator.
- C. **Flow rate adjustment according to the room temperature**, thanks to the combination with a thermostatic, electronic or thermo-electric control head. The flow rate adjustment is optimised because it is made pressure independent.

NEW

230

Kit for measuring Δp in the circuits with dynamic valves.



Code

230100



1

-

THERMOSTATIC RADIATOR VALVES



220

tech. broch. 01034

Angled thermostatic radiator valve fitted for thermostatic and electronic control heads, thermo-electric actuators. Chrome plated. For steel pipe. Max. working pressure: 10 bar. Temperature range: 5–100°C.

Code		Kvs (m ³ /h)*		
220302	3/8"	2,29	10	50
220402	1/2"	2,39	10	50
220500	3/4" without rubber seal	3,19	5	25



224

tech. broch. 01034

Reverse thermostatic radiator valve fitted for thermostatic and electronic control heads, thermo-electric actuators. Chrome plated. For steel pipe. Max. working pressure: 10 bar. Temperature range: 5–100°C.

Code		Kvs (m ³ /h)*		
224302	3/8"	0,93	1	20
224402	1/2"	1,39	1	20



221

tech. broch. 01034

Straight thermostatic radiator valve fitted for thermostatic and electronic control heads, thermo-electric actuators. Chrome plated. For steel pipe. Max. working pressure: 10 bar. Temperature range: 5–100°C.

Code		Kvs (m ³ /h)*		
221302	3/8"	1,05	10	50
221402	1/2"	1,52	10	50
221500	3/4" without rubber seal	2,20	5	25



227

tech. broch. 01034

Reverse thermostatic radiator valve fitted for thermostatic and electronic control heads, thermo-electric actuators. Chrome plated. For copper, single and multilayer plastic pipes. Max. working pressure: 10 bar. Temperature range: 5–100°C.

Code	Radiator connection	Pipe connection	Kvs (m ³ /h)*		
227402	1/2"	23 p.1,5	1,39	1	20



222

tech. broch. 01034

Angled thermostatic radiator valve fitted for thermostatic and electronic control heads, thermo-electric actuators. Chrome plated. For copper, single and multilayer plastic pipes. Max. working pressure: 10 bar. Temperature range: 5–100°C.

Code	Radiator connection	Pipe connection	Kvs (m ³ /h)*		
222302*	3/8"	23 p.1,5	2,29	10	50
222402	1/2"	23 p.1,5	2,39	10	50

* Without EN 215 certification



4490

Knob for thermostatic radiator valves. For valves 220, 221, 222, 223, 224, 225, 226, 227 series.

Code		
449010	1	100



223

tech. broch. 01034

Straight thermostatic radiator valve fitted for thermostatic and electronic control heads, thermo-electric actuators. Chrome plated. For copper, single and multilayer plastic pipes. Max. working pressure: 10 bar. Temperature range: 5–100°C.

Code	Radiator connection	Pipe connection	Kvs (m ³ /h)*		
223302*	3/8"	23 p.1,5	1,05	10	50
223402	1/2"	23 p.1,5	1,52	10	50

* Without EN 215 certification

*Kvs: flow rate for the valve equipped with thermostatic control head at the maximum open position.



The EN 215 certification covers the combination of codes 200000/200001 and 201, 204 series thermostatic control heads with valves 220, 221, 222, 223, 224, 225, 226 and 227 series.

DOUBLE-ANGLED THERMOSTATIC RADIATOR AND LOCKSHIELD VALVES





225

tech. broch. 01034

Double-angled thermostatic radiator valve fitted for thermostatic and electronic control heads, thermo-electric actuators.

Right-hand version.

Chrome plated.
For steel pipe (for copper pipe with 441 series).
Max. working pressure: 10 bar.
Temperature range: 5–100°C.

Code		Kvs (m ³ /h)*		
225312	3/8"	0,96	1	20
225412	1/2"	1,40	1	20



225



tech. broch. 01034

Double-angled lockshield valve.

Right-hand version.

Chrome plated.
For steel pipe.
Max. working pressure: 10 bar.
Temperature range: 5–100°C.



Code		Kvs (m ³ /h)*		
225352	3/8"	1,05	1	20
225452	1/2"	1,40	1	20





225

tech. broch. 01034

Double-angled thermostatic radiator valve fitted for thermostatic and electronic control heads, thermo-electric actuators.

Left-hand version.

Chrome plated.
For steel pipe.
Max. working pressure: 10 bar.
Temperature range: 5–100°C.

Code		Kvs (m ³ /h)*		
225322	3/8"	0,96	1	20
225422	1/2"	1,40	1	20



225



tech. broch. 01034

Double-angled lockshield valve.

Left-hand version.

Chrome plated.
For steel pipe.
Max. working pressure: 10 bar.
Temperature range: 5–100°C.



Code		Kvs (m ³ /h)*		
225362	3/8"	1,05	1	20
225462	1/2"	1,40	1	20





226

tech. broch. 01034

Double-angled thermostatic radiator valve fitted for thermostatic and electronic control heads, thermo-electric actuators.

Right-hand version.

Chrome plated.
For copper, single and multilayer plastic pipes.
Max. working pressure: 10 bar.
Temperature range: 5–100°C.

Code	Radiator connection	Pipe connection	Kvs (m ³ /h)*		
226412	1/2"	23 p,1,5	1,40	1	20



226



tech. broch. 01034

Double-angled lockshield valve.

Right-hand version.

Chrome plated.
For copper, single and multilayer plastic pipes.
Max. working pressure: 10 bar.
Temperature range: 5–100°C.



Code	Radiator connection	Pipe connection	Kvs (m ³ /h)*		
226452	1/2"	23 p,1,5	1,40	1	20





226

tech. broch. 01034

Double-angled thermostatic radiator valve fitted for thermostatic and electronic control heads, thermo-electric actuators.

Left-hand version.

Chrome plated.
For copper, single and multilayer plastic pipes.
Max. working pressure: 10 bar.
Temperature range: 5–100°C.

Code	Radiator connection	Pipe connection	Kvs (m ³ /h)*		
226422	1/2"	23 p,1,5	1,40	1	20



226



tech. broch. 01034

Double-angled lockshield valve.

Left-hand version.

Chrome plated.
For copper, single and multilayer plastic pipes.
Max. working pressure: 10 bar.
Temperature range: 5–100°C.



Code	Radiator connection	Pipe connection	Kvs (m ³ /h)*		
226462	1/2"	23 p,1,5	1,40	1	20

*Kvs: flow rate for the valve equipped with thermostatic control head at the maximum open position.



The EN 215 certification covers the combination of codes 200000/200001 and 201, 204 series thermostatic control heads with valves 220, 221, 222, 223, 224, 225, 226 and 227 series.

THERMOSTATIC CONTROL HEADS

Thermostatic control heads in I Class

EUnited Valves (The European Valve Manufacturers Association set up in Brussels) has prepared a classification system for products that manage home comfort and water responsibly in the residential field and, more specifically, for thermostatic valves.

Caleffi thermostatic control heads were included in the list of **TELL**-approved (Thermostatic Efficiency Label) products and were placed in the **I Efficiency Class**.

This classification guarantees that thermostatic valves are able to contribute to the energy saving of heating systems.

TELL
Thermostatic Efficiency Label

Manufacturer: **Caleffi S.p.A.**
Model: **200000**
Registration number: **10564-20150319**

I ▶

II ▶

III ▶

IV ▶

V ▶

VI ▶

I ▶

Information: www.tell-online.eu

A Label of EUnited Valves
European Valve Manufacturers Association

201

tech. broch. 01034

Thermostatic control head for thermostatic and convertible radiator valves.
With remote sensor.
For valves 338, 339, 401, 402, 425, 426, 421, 422, 230, 231, 232, 233, 234, 237, 220, 221, 222, 223, 224, 225, 226, 227, 455 and 456 series.
Graduated scale from * to 5 corresponding to a temperature adjustment range from 7°C to 28°C.
Capillary length: 2 m.
With adapter.



Code
201000

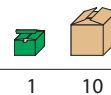

200

tech. broch. 01034

Thermostatic control head for convertible radiator valves.
Built-in sensor with liquid-filled element.
For valves 338, 339, 401, 402, 425, 426, 421, 422, 230, 231, 232, 233, 234, 237, 220, 221, 222, 223, 224, 225, 226, 227, 455 and 456 series.
Graduated scale from * to 5 corresponding to a temperature adjustment range from 7°C to 28°C.
With adapter.



Code
200000

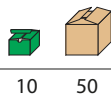

209

tech. broch. 01034

Tamper-proof anti-theft cap for use in public places.
For thermostatic control heads 200, 204, 202 and 205 series.
To be used with speciale allen key code 209001.



Code
209000

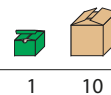

209

tech. broch. 01034

Special allen key for tamper-proof anti-theft cap.
To be used with tamperproof cap 209 series.



Code
209001

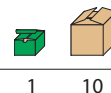

200

tech. broch. 01034

Thermostatic control head for convertible radiator valves.
Built-in sensor with liquid-filled element.
For valves 220, 221, 222, 223, 224, 225, 226 and 227 series.
Graduated scale from * to 5 corresponding to a temperature adjustment range from 7°C to 28°C.



Code
200001

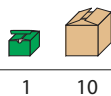

THERMOSTATIC CONTROL HEADS

204

tech. broch. 01242



Thermostatic control head for convertible radiator valves. Built-in sensor with liquid-filled element. For valves 338, 339, 401, 402, 425, 426, 421, 422, 230, 231, 232, 233, 234, 237, 220, 221, 222, 223, 224, 225, 226, 227, 455 and 456 series. Graduated scale from * to 5 corresponding to a temperature adjustment range from 7°C to 28°C. With adapter.

Code		
204000	10	50

204

tech. broch. 01242



Thermostatic control head for thermostatic and convertible radiator valves. With remote sensor. For valves 338, 339, 401, 402, 425, 426, 421, 422, 230, 231, 232, 233, 234, 237, 220, 221, 222, 223, 224, 225, 226, 227, 455 and 456 series. Graduated scale from * to 5 corresponding to a temperature adjustment range from 7°C to 28°C. Capillary length: 2 m. With adapter.

Code		
204100	1	10

202

tech. broch. 01009



Thermostatic control head for radiator valves. Built-in sensor with liquid-filled element. With LCD type ambient temperature indicator. For valves 338, 339, 401, 402, 425, 426, 421, 422, 230, 231, 232, 233, 234, 237, 220, 221, 222, 223, 224, 225, 226, 227, 455 and 456 series. Graduated scale from * to 5 corresponding to a temperature adjustment range from 7°C to 28°C. Room temperature indicator range: 16–26°C. With adapter.



Visibility with sufficient lighting

Room temperature indicator

The room temperature indicator is a LCD type. It gets green coloured in correspondence with the actual room temperature reading. A particular pivoting system keeps the indicator always in vertical position, thus allowing its optimal visualization.

Code		
202000	1	5

203

tech. broch. 01034



Thermostatic control head for thermostatic and convertible radiator valves; with contact probe, for medium temperature limiting. For valves 220, 221, 222, 223, 224, 225, 226, 227, 338, 339, 401, 402 and 455 series. Pre-set temperature scale. Capillary length: 2 m.

Code	Temperature range		
203502	20–50°C	1	25
203702	40–90°C	1	–

475

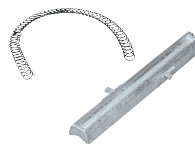

Contact probe mounting bracket. For thermostatic control heads 203 series.

Code		
475001	1	–

475



Probe pocket. For thermostatic control heads 203 series.

Code			
475002	for code 203502	1	–
475003	for code 203702	1	–

472



Thermostatic control head with remote adjusting knob, liquid-filled element. For valves 220, 221, 222, 223, 224, 225, 226, 227 series (direct coupling). For valves 338, 339, 401, 402, 455 series (coupling with adapter). Temperature range: 6–28°C. Capillary length: 2 m.

Code		
472000	1	5

THERMO-ELECTRIC ACTUATORS



6563

tech. broch. 01142

Thermo-electric actuator.
With manual opening and position indicator.
For valves 338, 339, 401, 402, 425, 426, 421, 422, 230, 231, 232, 233, 234, 237, 220, 221, 222, 223, 224, 225, 226, 227, 455 and 456 series.
Normally closed.
Supply: 230 V (ac) or 24 V (ac)/(dc).
Power consumption: 3 W.
Starting current: ≤ 1 A.
Starting current (656344): ≤ 250 mA.
Ambient temperature range: 0–50°C.
Protection class: IP 40.
Cable length: 80 cm.

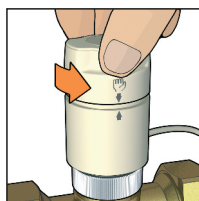

Code	Supply voltage V		
656302	230	1	10
656304	24	1	10

With low power consumption

Code	Supply voltage V		
656344	24	1	10



6563

tech. broch. 01142

Thermo-electric actuator.
With manual opening and position indicator.
For valves 338, 339, 401, 402, 425, 426, 421, 422, 230, 231, 232, 233, 234, 237, 220, 221, 222, 223, 224, 225, 226, 227, 455 and 456 series.
Normally closed.
With auxiliary microswitch.
Supply: 230 V (ac) or 24 V (ac)/(dc).
Power consumption: 3 W.
Starting current: ≤ 1 A.
Starting current (656354): ≤ 250 mA.
Auxiliary microswitch contact rating: 0,8 A (230 V).
Ambient temperature range: 0–50°C.
Protection class: IP 40.
Cable length: 80 cm.



Code	Supply voltage V		
656312	230	1	10
656314	24	1	10

With low power consumption

Code	Supply voltage V		
656354	24	1	10



6561

tech. broch. 01042

Thermo-electric actuator.
For valves 338, 339, 401, 402, 425, 426, 421, 422, 230, 231, 232, 233, 234, 237, 220, 221, 222, 223, 224, 225, 226, 227, 455 and 456 series.
Normally closed.
Supply: 230 V (ac) or 24 V (ac)/(dc).
Power consumption: 3 W.
Starting current: ≤ 1 A.
Ambient temperature range: 0–50°C.
Protection class: IP 44 (vertical stem).
Cable length: 80 cm.



Code	Supply voltage V		
656102	230	1	10
656104	24	1	10

6561

tech. broch. 01042



Thermo-electric actuator.
For valves 338, 339, 401, 402, 425, 426, 421, 422, 230, 231, 232, 233, 234, 237, 220, 221, 222, 223, 224, 225, 226, 227, 455 and 456 series.
Normally closed.
With auxiliary microswitch.
Supply: 230 V (ac) or 24 V (ac)/(dc).
Auxiliary microswitch contact rating: 0,8 A (230 V).
Power consumption: 3 W.
Starting current: ≤ 1 A.
Ambient temperature range: 0–50°C.
Protection class: IP 44 (vertical stem).
Cable length: 80 cm.



Code	Supply voltage V		
656112	230	1	10
656114	24	1	10

THERMO-ELECTRIC ACTUATORS

6562

tech. broch. 01198



Thermo-electric actuator.
With opening position indicator.
Quick-coupling installation, with a clip adapter.
For valves 338, 339, 401, 402, 425, 426, 421, 422, 230, 231, 232, 233, 234, 237, 220, 221, 222, 223, 224, 225, 226, 227, 455 and 456 series.
Normally closed.
Supply: 230 V (ac) or 24 V (ac)/(dc).
Power consumption: 3 W.
Starting current: ≤ 1 A.
Ambient temperature range: 0–50°C.
Protection class: IP 54.
Cable length: 80 cm.

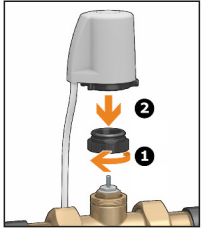

Code	Supply voltage V		
656202	230	1	10
656204	24	1	10

6564

tech. broch. 01198



Thermo-electric actuator
with low power consumption.
With opening position indicator.
Quick-coupling installation, with a clip adapter.
For valves 338, 339, 401, 402, 425, 426, 421, 422, 230, 231, 232, 233, 234, 237, 220, 221, 222, 223, 224, 225, 226, 227, 455 and 456 series.
Normally closed.
Supply: 230 V (ac) or 24 V (ac)/(dc).
Power consumption: 3 W.
Starting current: ≤ 250 mA.
Ambient temperature range: 0–50°C.
Protection class: IP 54.
Cable length: 80 cm.



Code	Supply voltage V		
656402	230	1	10
656404	24	1	10

6562

tech. broch. 01198



Thermo-electric actuator.
With opening position indicator.
Quick-coupling installation, with a clip adapter.
For valves 338, 339, 401, 402, 425, 426, 421, 422, 230, 231, 232, 233, 234, 237, 220, 221, 222, 223, 224, 225, 226, 227, 455 and 456 series.
Normally closed.
With auxiliary microswitch.
Supply: 230 V (ac) or 24 V (ac)/(dc).
Auxiliary microswitch contact rating: 0,8 A (230 V).
Power consumption: 3 W.
Starting current: ≤ 1 A.
Ambient temperature range: 0–50°C.
Protection class: IP 54.
Cable length: 80 cm.



Code	Supply voltage V		
656212	230	1	10
656214	24	1	10

6564

tech. broch. 01198



Thermo-electric actuator
with low power consumption.
With opening position indicator.
Quick-coupling installation, with a clip adapter.
For valves 338, 339, 401, 402, 425, 426, 421, 422, 230, 231, 232, 233, 234, 237, 220, 221, 222, 223, 224, 225, 226, 227, 455 and 456 series.
Normally closed.
With auxiliary microswitch.
Supply: 230 V (ac) or 24 V (ac)/(dc).
Auxiliary microswitch contact rating: 0,8 A (230 V).
Power consumption: 3 W.
Starting current: ≤ 250 mA.
Ambient temperature range: 0–50°C.
Protection class: IP 54.
Cable length: 80 cm.



Code	Supply voltage V		
656412	230	1	10
656414	24	1	10



Adapter for installing thermostatic and thermo-electric actuator with valves 338, 339, 401, 402, 425, 426, 421, 422, 455 and 456 series.

Code

F36077

ELECTRONIC THERMAL CONTROL SYSTEM FOR RADIATORS

STAND ALONE system



210 WiCal®

tech. broch. 01263

Stand alone chrono-thermostatic control head, with backlit display. For thermostatic and convertible radiator valves. Touch button operation, built-in temperature sensor. Programmable directly, with displaying of temperatures and comfort-set back cycles. Battery electric supply: 2 x 1,5 V AA (in package). Quick-coupling installation with adaptor. Protection class: IP 30.

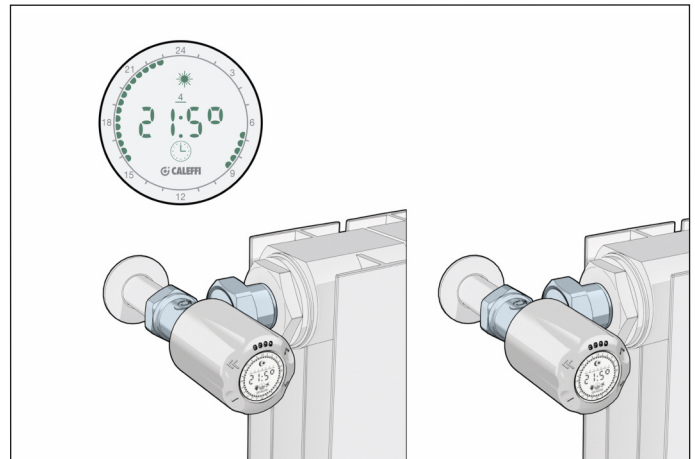

Code

210500

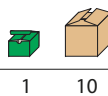

1

10

RADIO WAVE system



210 WiCal®

tech. broch. 01263

Electronic **radio wave** control head. For thermostatic and convertible radiator valves. Touch button operation, built-in temperature sensor. Can be connected to multi-zone thermal controller code 210100. Radio communication RF 868 MHz. Battery electric supply: 2 x 1,5 V AA (in package). Quick-coupling installation with adaptor. Protection class: IP 30.

Operating principle

The **radio wave** thermal control system comprises:

- multi-zone thermal controller
- electronic control head for radiator valve
- ambient temperature sensor (optional)

The thermal controller manages the temperature in different rooms by controlling the electronic actuators installed on the valves on each radiator. The actual temperature is measured by the sensors in the room and/or integrated into the control head. Depending on the set temperature parameters and the comfort or set back cycles, the controller sends a modulating opening or closing signal to the actuators and an ON/OFF signal to the boiler. The system is managed by radio wave signals.

The functional details include:

- easy and quick linking of wireless devices for rapid installation;
- management of up to 8 temperature zones, which in turn are each able to control up to 4 actuators, thus with maximum system expansion of up to 32 actuators;
- easy individual time band programming for each zone, for every day of the week. Pre-set time band programmes and customisable programmes.

Code

210510

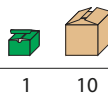

1

10



210 WiCal®

tech. broch. 01263

Radio wave multi-zone thermal controller. For managing electronic control heads code 210510. Radio communication RF 868 MHz. Transmission distance 30 m in closed rooms. Colour TFT graphic display. Touch button operation. Possibility to control the heat settings in up to 8 different zones. Auto - Holiday - Eco - Comfort functions. Electric supply: 24 V (dc). Auxiliary contact for heating request: 5 A. Protection class: IP 30. **Power supply unit: 230 V (ac) / 24 V (dc).**

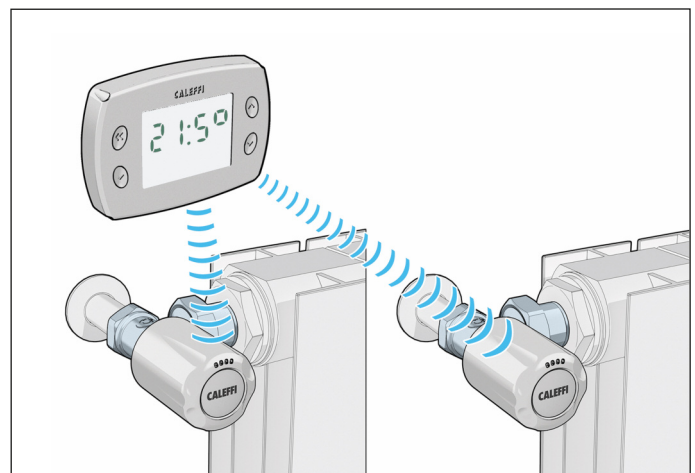

Code

210100 I - GB - D - F

210101 ES - NL - PT - F

210102 SL - HR - SR - SK



1

10

ELECTRONIC THERMAL CONTROL SYSTEM FOR RADIATORS

RADIO WAVE system



210 WiCal®

tech. broch. 01263

Radio wave ambient temperature sensor. For individual zone or room temperature control. Radio communication RF 868 MHz. Can be connected to multi-zone thermal controller 210 series. Electric supply with photovoltaic cell and buffer battery. Protection class: IP 30.

Code		
210001	1	14



210

GSM interface module for remote control of WiCal®, complete with room temperature probe. Radio communication RF 868 MHz. Electric supply: 230 V (ac). GSM / GPRS Quadri-band. Power consumption: max. 1,4 W. Installation in DIN template.

Code		
210015	1	-



210 WiCal®

Radio wave open window sensor. For individual zone or room heating temporary interruption. Radio communication RF 868 MHz. Can be connected to multi-zone thermal controller 210 series. Electric supply with photovoltaic cell and buffer battery. Protection class: IP 30.

Code		
210009	1	-

Operating principle
The module allows a GSM connection to the WiCal® controller. Through an SMS it is possible to set the WiCal® controller in the operating mode "AUTO" or "OFF". The module shows, via SMS, the temperature as detected by the on-board sensor.



210

tech. broch. 01263

1st and 2nd level wireless signal repeater with antenna. Recessed or false ceiling version. Electric supply: 230 V (ac). Radio communication RF 868 MHz. Transmission distance 30 m in closed rooms. Stand-by power consumption: 0,6 W.

Code		
210010	1	-

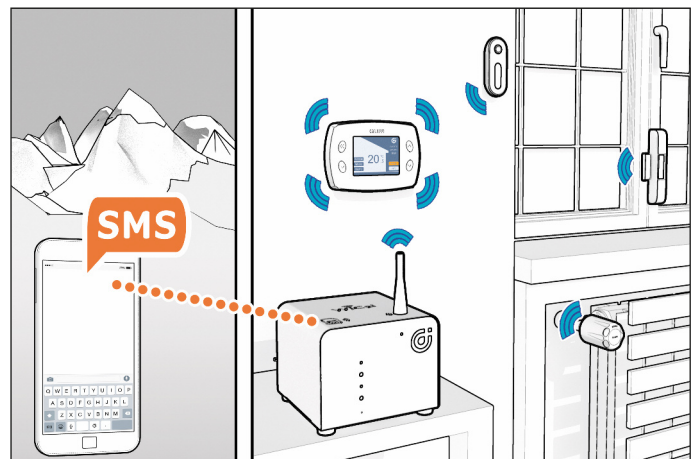

210

tech. broch. 01263

Radio wave 1st and 2nd level signal repeater with plug for power output. Electric supply: 230 V (ac). Radio communication RF 868 MHz. Transmission distance 30 m in closed rooms. Stand-by power consumption: 0,9 W.

Code		
210011	1	-



210

tech. broch. 01263

Pair of lithium batteries.

Code		
210008	1	-



210

tech. broch. 01263

Click switch - Radio wave and battery-less switch transmitter. Radio communication RF 868 MHz. The three buttons allow to activate for all the zones the operating modes ECO (saving mode), AUTO (automatic mode), OFF (switched off mode) without acting directly on the controller.

Code		
210006	1	-

Accessories and spare parts for electronic thermal control system 210 series.

Code		
210005	tamper-proof kit for actuators	1 10
F49671	adapter for 455 series	1 -
210007	radio signals checking and validation tester	1 -
210004	power supply unit spare part for code 210100	1 -

MANUAL RADIATOR AND LOCKSHIELD VALVES



340

tech. broch. 01030

Angled manual radiator valve.
Chrome plated.
For copper, single and multilayer plastic pipes.
Max. working pressure: 10 bar.
Temperature range: 5–100°C.

Code	Radiator connection	Pipe connection	Kv (m ³ /h)		
340302	3/8"	23 p.1,5	2,42	10	50
340402	1/2"	23 p.1,5	3,99	10	50
340452	1/2"	3/4"	3,99	10	50



342

tech. broch. 01030

Angled lockshield valve.
Chrome plated.
For copper, single and multilayer plastic pipes.
Max. working pressure: 10 bar.
Temperature range: 5–100°C.

Code	Radiator connection	Pipe connection	Kv (m ³ /h) fully open		
342302	3/8"	23 p.1,5	2,42	10	50
342402	1/2"	23 p.1,5	3,99	10	50
342452	1/2"	3/4"	3,99	10	50



341

tech. broch. 01030

Straight manual radiator valve.
Chrome plated.
For copper, single and multilayer plastic pipes.
Max. working pressure: 10 bar.
Temperature range: 5–100°C.

Code	Radiator connection	Pipe connection	Kv (m ³ /h)		
341302	3/8"	23 p.1,5	1,32	10	50
341402	1/2"	23 p.1,5	2,17	10	50



343

tech. broch. 01030

Straight lockshield valve.
Chrome plated.
For copper, single and multilayer plastic pipes.
Max. working pressure: 10 bar.
Temperature range: 5–100°C.

Code	Radiator connection	Pipe connection	Kv (m ³ /h) fully open		
343302	3/8"	23 p.1,5	1,32	10	50
343402	1/2"	23 p.1,5	2,17	10	50



411

tech. broch. 01030

Angled manual radiator valve.
Chrome plated.
For steel pipe.
Max. working pressure: 10 bar.
Temperature range: 5–100°C.

Code	Radiator connection	Pipe connection	Kv (m ³ /h)		
411302	3/8"		2,42	10	50
411402	1/2"		3,99	10	50
401500*	3/4"	without rubber seal	3,36	5	25
401603*	1"	without rubber seal	4,47	5	25

* convertible radiator valve



431

tech. broch. 01030

Angled lockshield valve.
Chrome plated.
For steel pipe.
Max. working pressure: 10 bar.
Temperature range: 5–100°C.

Code	Radiator connection	Pipe connection	Kv (m ³ /h) fully open		
431302	3/8"		2,42	10	50
431402	1/2"		3,99	10	50
431503	3/4"	without rubber seal	4,52	5	25
431603	1"	without rubber seal	5,64	5	25



412

tech. broch. 01030

Straight manual radiator valve.
Chrome plated.
For steel pipe.
Max. working pressure: 10 bar.
Temperature range: 5–100°C.

Code	Radiator connection	Pipe connection	Kv (m ³ /h)		
412302	3/8"		1,32	10	50
412402	1/2"		2,17	10	50
412503	3/4"	without rubber seal	2,58	5	25
402603*	1"	without rubber seal	4,43	5	25

* convertible radiator valve



432

tech. broch. 01030

Straight lockshield valve.
Chrome plated.
For steel pipe.
Max. working pressure: 10 bar.
Temperature range: 5–100°C.

Code	Radiator connection	Pipe connection	Kv (m ³ /h) fully open		
432302	3/8"		1,32	10	50
432402	1/2"		2,17	10	50
432503	3/4"	without rubber seal	2,58	5	25
432603	1"	without rubber seal	4,81	5	25

ONE-PIPE AND TWO-PIPE RADIATOR VALVES FOR DESIGNER HEATING SYSTEMS

4005

tech. broch. 01324

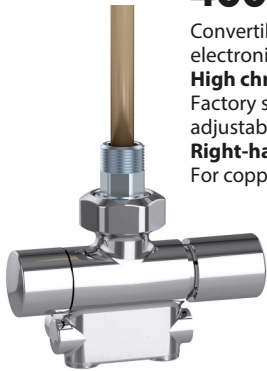

Convertible radiator valve fitted for thermostatic and electronic control heads, thermo-electric actuators.

High chrome finish.

Factory set for one-pipe systems, adjustable for two-pipe systems.

Right-hand version.

For copper, single and multilayer plastic pipes.

Flow rate to the radiator:

- with manual control knob: 45%,
- with thermostic control head (proportional band 2K): 30%.

Outlet centre distance: 40 mm.

Brass probe: 40 cm.

Max. working pressure: 10 bar.

Temperature range: 5–100°C.

Code	Radiator connection	Pipe connection	Kv (m ³ /h)			
			one-pipe	two-pipe		
400510	1/2"	23 p.1,5	1,6	0,96	1	5

One-pipe application

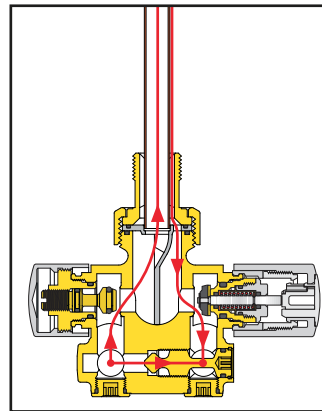

Two-pipe application

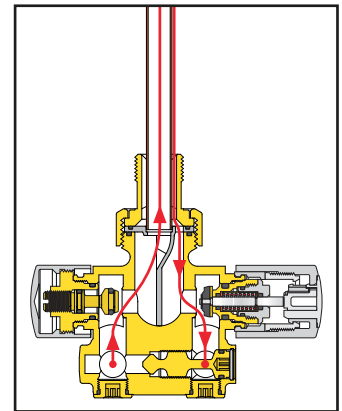

Flow and return connections can be inverted by means of the rotation of the specific deflector.

4005

tech. broch. 01324

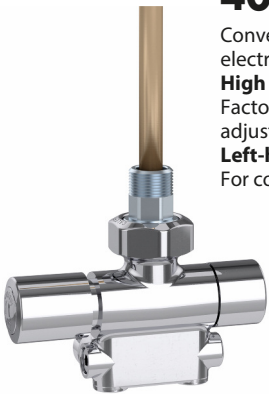

Convertible radiator valve fitted for thermostatic and electronic control heads, thermo-electric actuators.

High chrome finish.

Factory set for one-pipe systems, adjustable for two-pipe systems.

Left-hand version.

For copper, single and multilayer plastic pipes.

Flow rate to the radiator:

- with manual control knob: 45%,
- with thermostic control head (proportional band 2K): 30%.

Outlet centre distance: 40 mm.

Brass probe: 40 cm.

Max. working pressure: 10 bar.

Temperature range: 5–100°C.

Code	Radiator connection	Pipe connection	Kv (m ³ /h)			
			one-pipe	two-pipe		
400520	1/2"	23 p.1,5	1,6	0,96	1	5

Installation example of the designer heating system radiator valve, vertical probe, left-hand version, with thermostatic control head



VALVES FOR ONE-PIPE SYSTEMS

456

tech. broch. 01323

Convertible radiator valve fitted for thermostatic and electronic control heads, thermo-electric actuators.

For one-pipe systems.

For copper, single and multilayer plastic pipes.

Flow rate to the radiator:

- with manual control knob: 27%,
- with thermostic control head (proportional band 2K): 20%.

Outlet centre distance: 35 mm.

PP probe: 33 cm.

Max. working pressure: 10 bar.

Temperature range: 5÷100°C.



Code	Radiator connection	Pipe connection	Kv (m ³ /h)			
			one-pipe	two-pipe		
456400	1/2"	23 p.1,5	1,6	10	10	-
456500	3/4"	23 p.1,5	1,6	10	10	-

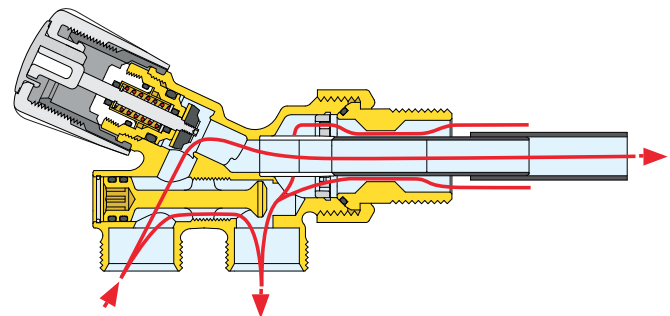

Flow and return connections can be inverted

ONE-PIPE AND TWO-PIPE RADIATOR VALVES

455

tech. broch. 01051

Convertible radiator valve fitted for thermostatic control heads and thermo-electric actuator. Chrome plated. Factory set for one-pipe systems, adjustable for two-pipe systems. For copper, single and multilayer plastic pipes. Outlet centre distance: 40 mm. Brass probe: 30 cm. Max. working pressure: 10 bar. Temperature range: 5–100°C.

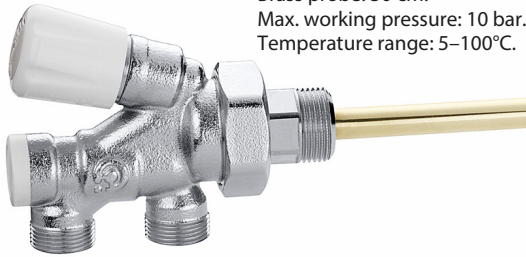

Code	Radiator connection	Pipe connection	Kv (m³/h)		Green box	Brown box
			one-pipe	two-pipe		
455400	1/2"	23 p.1,5	2,00	1,10	10	–
455500	3/4"	23 p.1,5	2,00	1,10	10	–
455600	1" right	23 p.1,5	2,00	1,10	10	–
455601	1" left	23 p.1,5	2,00	1,10	10	–

4501

Radiator valve for one-pipe systems. Chrome plated. For copper, single and multilayer plastic pipes. Flow rate to the radiator: 100%. Without template and wall-covering plate. Outlet centre distance: 40 mm. Brass probe: 30 cm. Max. working pressure: 10 bar. Max. working temperature: 100°C.

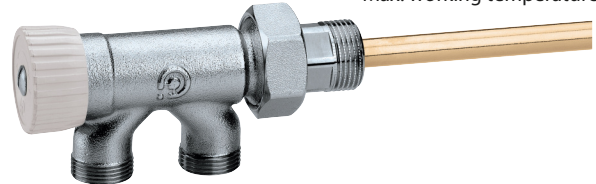

Code	Radiator connection	Pipe connection	Kv (m³/h)	Green box	Brown box
450150	3/4"	23 p.1,5	3,70	10	–

348

Radiator valve for one-pipe systems. Chrome plated. For copper, single and multilayer plastic pipes. Flow rate to the radiator: 100%. With front adjusting handle. Without template and wall-covering plate. Outlet centre distance: 40 mm. Brass probe: 30 cm. Max. working pressure: 10 bar. Max. working temperature: 100°C.

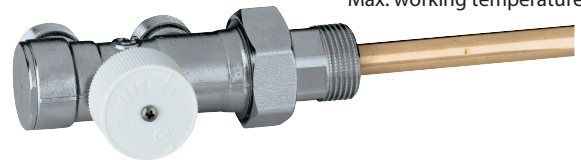

Code	Radiator connection	Pipe connection	Kv (m³/h)	Green box	Brown box
348500	3/4"	23 p.1,5	3,50	10	–

One-pipe application

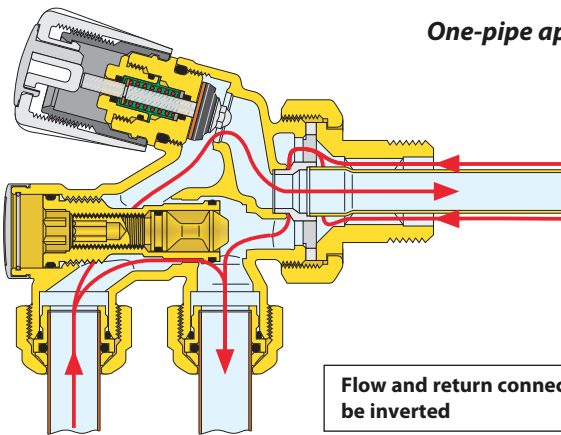

Flow and return connections can be inverted

Two-pipe application

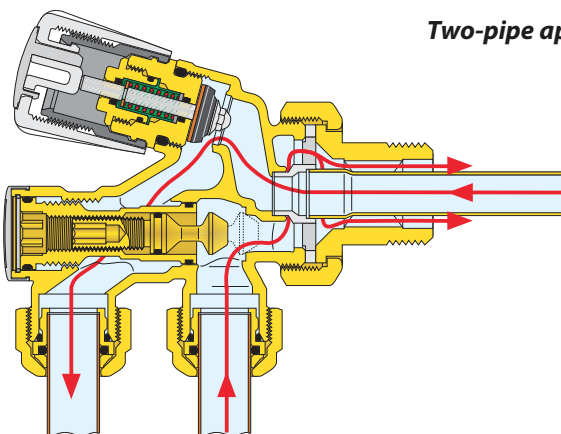

452

Radiator valve for one-pipe systems. Chrome plated. For copper, single and multilayer plastic pipes. Flow rate to the radiator: 50%. For Ø 15 mm outside probe (454 series). Wall connections. Complete with template, wall-covering plate and probe connection. Outlet centre distance: 40 mm. Max. working pressure: 10 bar. Max. working temperature: 100°C.

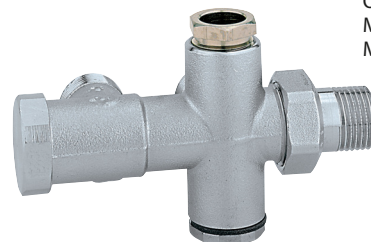

Code	Radiator connection	Pipe connection	Kv (m³/h)	Green box	Brown box

ONE-PIPE AND TWO-PIPE RADIATOR VALVES AND ACCESSORIES

452

Radiator valve for two-pipe systems.
 Chrome plated.
 For copper, single and multilayer plastic pipes.
 For Ø 15 mm outside probe (454 series).
 Wall connections.
 Complete with template, wall-covering plate
 and probe connection.

Outlet centre distance: 40 mm.
 Max. working pressure: 10 bar.
 Max. working temperature: 100°C.



Code	Radiator connection	Pipe connection	Kv (m ³ /h)		
452401	1/2"	23 p.1,5	1,80	1	25

459

Angled connection for one-pipe valves 328 and 452 series and convertible radiator valves code 339402.
 Chrome plated.



Code	Interasse		
459001	1/2" M x 3/4" F nut	10	-

4496

Wall template.
 For valves 4501, 452, 328, 348 and 455 series.
 Outlet centre distance: 40 mm.

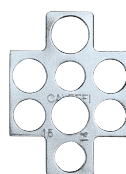

Code	Interasse		
449640		10	-

328

Radiator valve for one-pipe systems.
 Chrome plated.
 For copper, single and multilayer plastic pipes.
 Flow rate to the radiator: 50%.
 For Ø 15 mm outside probe (454 series).
 Floor connections.
 Complete with probe connection.

Outlet centre distance: 40 mm.
 Max. working pressure: 10 bar.
 Max. working temperature: 100°C.



Code	Radiator connection	Pipe connection	Kv (m ³ /h)		
328400	1/2"	23 p.1,5	2,20	1	20

453

Brass pipe extension for probe.
 For valves 348, 4501 and 455 series.



Code	Interasse		
453020	200 mm (x 348-4501-455400-455500)	10	-
453030	300 mm (x 455600-455601)	10	-

454

Ø 15 mm brass outside probe. Chrome plated.
 To be connected with valves 452 and 328 series at the bottom and radiator valves 223, 227, 339 and 341 series.



Code	Interasse		
454060	600 mm	5	-
454090	900 mm	5	-

328

Radiator valve for two-pipe systems.
 Chrome plated.
 For copper, single and multilayer plastic pipes.
 For Ø 15 mm outside probe (454 series).
 Floor connections.
 Complete with probe connection.

Outlet centre distance: 40 mm.
 Max. working pressure: 10 bar.
 Max. working temperature: 100°C.



Code	Radiator connection	Pipe connection	Kv (m ³ /h)		
328401	1/2"	23 p.1,5	1,80	1	20

NEW

4499

Single wall-covering plate.
 White colour RAL 9010.
 For pipes with external diameter from 12 to 20 mm.

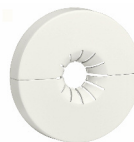

Code	Interasse		
449900		2	100

NEW

4499

Double wall-covering plate.
 White colour RAL 9010.
 For pipes with external diameter from 12 to 20 mm.

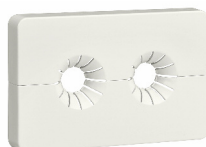

Code	Interasse		
449901	35 mm	2	50
449902	40 mm	2	50

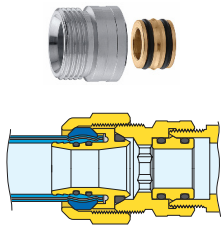

383
 Connection fitting with O-Ring seal for use with 3/4" 679 and 681 series. Chrome plated.

Code			
383551	3/4" M x 23 p.1,5 F	10	100



382
 Reduced tailpiece. Chrome plated.

Code			
382532	3/4" F nut x 3/8" M	1	-



381
 Telescopic union tailpiece with nut for radiator valves and lockshield valves. Extension range: 15 mm. Max. working pressure: 10 bar. Max. working temperature: 100°C. Chrome plated.

Code			
381302	1/2" F nut x 3/8" M	1	10
381402	3/4" F nut x 1/2" M	1	10



383
 Female fitting - olive coupling. Chrome plated.

Code			
383151	3/4" M x 23 p.1,5 F	10	-



384
 Male fitting - olive coupling. Chrome plated.

Code			
384031	3/8" M x 23 p.1,5 M	10	-
384041	1/2" M x 23 p.1,5 M	10	-



382
 Fitting with 23 p.1,5 captive nut. Chrome plated. Max. working pressure: 10 bar. Max. working temperature: 100°C.

Code			
382000	23 p.1,5 M x 23 p.1,5 F nut	10	-



942
 Sleeve. Chrome plated.

Code			
942551	3/4" M x 3/4"	1	-
942561	3/4" M x 1"	1	-



936
 Extension for connection between elbow fitting 933 series and radiator valves. Annealed copper, chrome plated. With shaped rubber seal. Length: 200 mm (useful 188 mm).

Code			
936400	1/2" x Ø 16	1	50

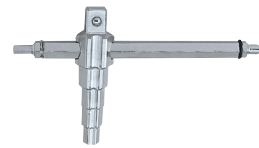

3871
 Universal key. Use for 3/8" to 1" union tailpiece.

Code			
387127		1	10



3871
 Wrench for 26 and 30 mm hexagonal nuts. For fittings 437, 447, 679, 680, 681 23 p.1,5 and 3/4" series.

Code			
387100		1	4



560 tech. broch. 01056
 Drain cock for radiators and wall-mounted boilers. Max. working pressure: 10 bar. Max. working temperature: 100°C. Chrome plated.

Code			
560421 ♦	1/2"	10	-
560000	extractor hose connection	25	-

♦ One extractor hose connection code 560000 is included in each 10-item package.

3872

Replacement kit for radiator valves headwork. Equipped with 20 spare headworks (only for valves without pre-setting) **Only for 3/8" and 1/2" valves.**

For valves 338, 339, 401, 402, 425, 426, 421, 422, 230, 231, 232, 233, 234, 237, 220, 221, 222, 223, 224, 225, 226, 227, 456 and 4005.



Code **387201** 1 -

NEW



Spare headworks for convertible and thermostatic radiator valves 338, 339, 401, 402, 220, 221, 222, 223, 224, 227, 225 and 226 series. Only for 3/8" and 1/2" sizes.

Code **F39146** 1 -



Spare headworks for convertible radiator valves with pre-setting 425, 426, 421 and 422 series. Only for 3/8" and 1/2" sizes.

Code **F49290** 1 -



Spare headworks for dynamic thermostatic radiator valves 230, 231, 232, 233, 234 and 237 series.

Code **230000** 1 -

3872

Adapting kit for headwork tool code 387200 to new headwork tool code 387201.



Code **387211** 1 -



Spare headworks for reverse flow for convertible and thermostatic radiator valves 338, 339, 401, 402, 220, 221, 222, 223, 224, 227, 225 and 226 series. Only for 3/8" and 1/2" sizes. PATENT PENDING.

Code **338000** 1 -

230

Δp measuring kit for circuit with dynamic valves.



Code **230100** 1 -



Spare headworks for reverse flow for convertible radiator valves with pre-setting 421, 422, 425 and 426 series. Only for 3/8" and 1/2" sizes. PATENT PENDING.

Code **421000** 1 -

Installation with reverse flow

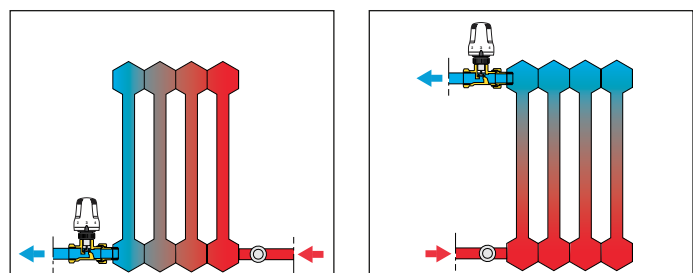

FITTINGS



679
DARCAL

Fitting for multilayer plastic pipes for continuous high temperature use.
Max. working pressure: 10 bar.
Temperature range: 0–95°C.
Chrome plated.

For a correct use, adjust the multilayer pipe diameter before installation using the Caleffi calibrator 679 series (see page 68).

Code			
679014	23 p.1,5 - Ø 14x2	10	100
679024	23 p.1,5 - Ø 16x2	10	100
679025	23 p.1,5 - Ø 16x2,25	10	100
679044	23 p.1,5 - Ø 18x2	10	100
679064	23 p.1,5 - Ø 20x2 with metal ring	10	100
679065	23 p.1,5 - Ø 20x2,25	10	100
679066	23 p.1,5 - Ø 20x2,5	10	100

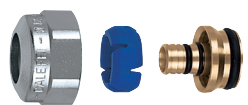

681
DARCAL

Self-adjustable diameter fitting for single and multilayer plastic pipes.
Max. working pressure: 10 bar.
Temperature range:
5–80°C (PE-X)
5–75°C (Multilayer marked 95°C).
Chrome plated.

Code		$\varnothing_{\text{inside}}$	$\varnothing_{\text{outside}}$		
681000	23 p.1,5	7,5– 8	12–14	10	100
681002	23 p.1,5	9 – 9,5	14–16	10	100
681001	23 p.1,5	9,5–10	12–14	10	100
681006	23 p.1,5	9,5–10	14–16	10	100
681015	23 p.1,5	10,5–11	14–16	10	100
681017	23 p.1,5	10,5–11	16–18	10	100
681024	23 p.1,5	11,5–12	14–16	10	100
681026	23 p.1,5	11,5–12	16–18	10	100
681035	23 p.1,5	12,5–13	16–18	10	100
681044	23 p.1,5	13,5–14	16–18	10	100

Example: 681 series fitting selection

Known both the outside and inside diameters (ex.: **17 mm** and **13 mm**);
or known the outside diameter (ex.: \varnothing_o **17 mm**) and the thickness (ex.: **th. 2 mm**) and considering that:

$$\varnothing_{\text{outside}} - 2 \cdot \text{th.} = \varnothing_{\text{inside}}$$

17 - 2 · 2 = 13 mm

Look within the table for the code matching both diameters:

Code		$\varnothing_{\text{inside}}$	$\varnothing_{\text{outside}}$
681035	23 p.1,5	12,5–13	16–18



447

Pre-assembled compression fitting, for soft annealed copper, hard copper, brass, mild and stainless steel pipes.
With O-Ring seal.
Max. working pressure: 10 bar.
Temperature range: -25–120°C.
Chrome plated.

Code			
447010	23 p.1,5 - Ø 10	100	–
447012	23 p.1,5 - Ø 12	100	–
447014	23 p.1,5 - Ø 14	100	–
447015	23 p.1,5 - Ø 15	100	–
447016	23 p.1,5 - Ø 16	100	–



437

Compression fitting, for soft annealed copper, hard copper, brass, mild and stainless steel pipes.
With O-Ring seal.
Max. working pressure: 10 bar.
Temperature range: -25–120°C.
Chrome plated.

Code			
437010	23 p.1,5 - Ø 10	100	–
437012	23 p.1,5 - Ø 12	100	–
437014	23 p.1,5 - Ø 14	100	–
437015	23 p.1,5 - Ø 15	100	–
437016	23 p.1,5 - Ø 16	100	–

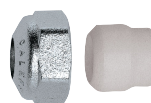

438

Compression fitting for copper pipe, with PTFE seal.
Chrome plated.

Code			
438010	23 p.1,5 - Ø 10	100	–
438012	23 p.1,5 - Ø 12	100	–
438014	23 p.1,5 - Ø 14	100	–
438015	23 p.1,5 - Ø 15	100	–
438016	23 p.1,5 - Ø 16	100	–
438018	23 p.1,5 - Ø 18 with metal olive	100	–

FITTINGS



679
DARCAL

Fitting for multilayer plastic pipes for continuous high temperature use.
Max. working pressure: 10 bar.
Temperature range: 0–95°C.
Chrome plated.

For a correct use, adjust the multilayer pipe diameter before installation using the Caleffi calibrator 679 series (see page 68).

Code			
679264	3/4" - Ø 20x2	10	100
679265	3/4" - Ø 20x2,25	10	100
679266	3/4" - Ø 20x2,5	10	100



437

Compression fitting, for annealed copper, hard copper, brass, mild and stainless steel pipes.
With O-Ring seal.
Max. working pressure: 10 bar.
Temperature range: -25–120°C.
Chrome plated.
For connecting pipes to special valves for panel radiators.

Code			
437510	3/4" - Ø 10	100	-
437512	3/4" - Ø 12	100	-
437514	3/4" - Ø 14	100	-
437515	3/4" - Ø 15	100	-
437516	3/4" - Ø 16	100	-
437518	3/4" - Ø 18	10	-

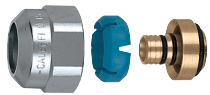

681
DARCAL

Self-adjustable diameter fitting for single and multilayer plastic pipes.
Max. working pressure: 10 bar.
Temperature range:
5–80°C (PE-X)
5–75°C (Multilayer marked 95°C).
Chrome plated.

Code		Ø _{inside}	Ø _{outside}		
681502	3/4"	7,5– 8	12–14	10	100
681500	3/4"	9 – 9,5	14–16	10	100
681501	3/4"	9,5–10	12–14	10	100
681506	3/4"	9,5–10	14–16	10	100
681515	3/4"	10,5–11	14–16	10	100
681517	3/4"	10,5–11	16–18	10	100
681524	3/4"	11,5–12	14–16	10	100
681526	3/4"	11,5–12	16–18	10	100
681535	3/4"	12,5–13	16–18	10	100
681537	3/4"	12,5–13	18–20	10	100
681546	3/4"	13,5–14	18–20	10	100
681555	3/4"	14,5–15	18–20	10	100
681556	3/4"	15 –15,5	18–20	10	100
681564	3/4"	15,5–16	18–20	10	100

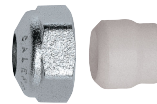

438

Compression fitting for copper pipe, with PTFE seal.
Chrome plated.

Code			
438512	3/4" - Ø 12	100	-
438514	3/4" - Ø 14	100	-
438515	3/4" - Ø 15	100	-
438516	3/4" - Ø 16	100	-
438518	3/4" - Ø 18	100	-

CALIBRATOR FOR MULTILAYER PIPES

679

Calibrator and handle to adjust multilayer pipes diameter before use with fittings 679 series.



Multilayer pipe calibration and installation of fitting components 679 series

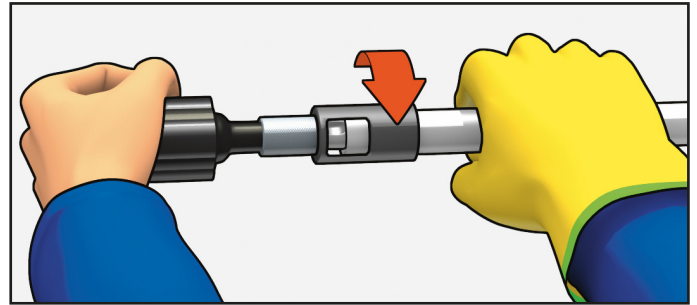

Code



679001	calibrator Ø 14x2	1	–
679002	calibrator Ø 16x2	1	–
679003	calibrator Ø 16x2,25	1	–
679004	calibrator Ø 18x2	1	–
679006	calibrator Ø 20x2	1	–
679007	calibrator Ø 20x2,25	1	–
679008	calibrator Ø 20x2,5	1	–
679009	handle for calibrator	1	–

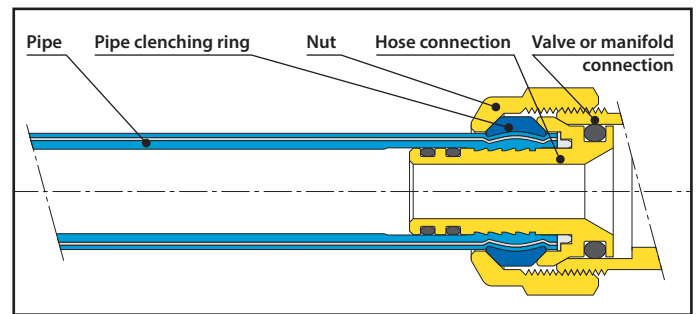

VALVES FOR PANEL RADIATORS

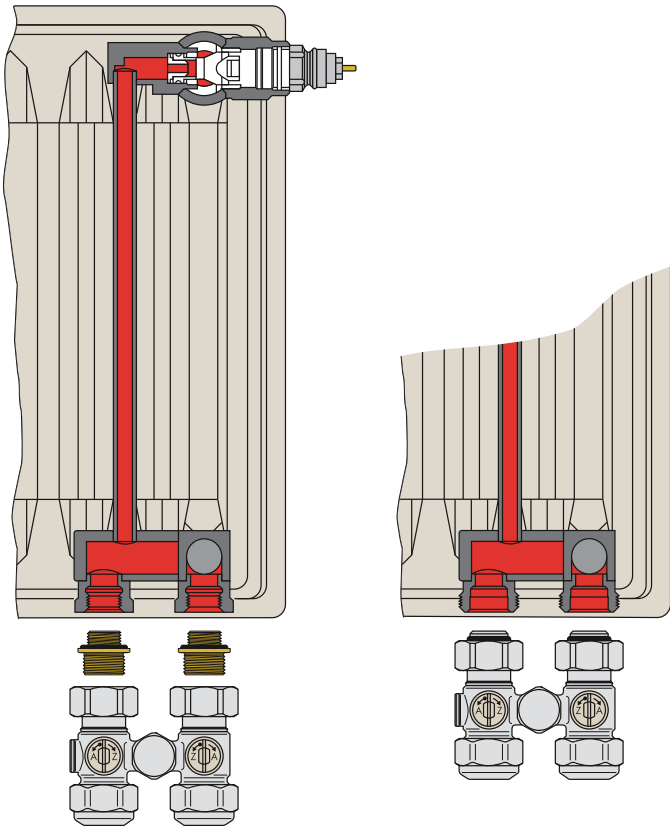

This valves are installed on a particular kind of panel radiators, featuring both the connections at the bottom and an inner pipe, invisible from outside, providing the flow medium to the upper valve.

They come in two versions: for two-pipe and one-pipe systems. Both are available straight (pipes exiting the floor) and angled (pipes exiting the wall). The two-pipe version is equipped with two ball shut-off valves; the one-pipe, in addition to the shut-off valves, is equipped with an adjustable by-pass from 30% to 50% of the flow rate towards the radiator.

3010



Valve for panel radiators with built-in thermostatic valve unit. Single valve straight version (floor connections) with 1/2" F radiator connections.
Max. working pressure: 10 bar.
Max. working temperature: 100°C.

Code	Radiator connection	Pipe connection		
301040	1/2" M	3/4"	1	25

3011

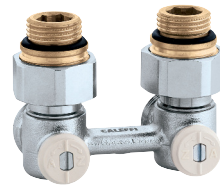

Valve for panel radiators with built-in thermostatic valve unit. Single valve angled version (wall connections) with 1/2" F radiator connections.
Max. working pressure: 10 bar.
Max. working temperature: 100°C.

Code	Radiator connection	Pipe connection		
301140	1/2" M	3/4"	1	25

3012



Valve for panel radiators with built-in thermostatic valve unit. One-pipe straight version (floor connections) with 1/2" F radiator connections.
With adjustable by-pass.
With non-return device.
Max. working pressure: 10 bar.
Max. working temperature: 100°C.

Code	Radiator connection	Pipe connection		
301241	1/2" M	3/4"	1	25

3013

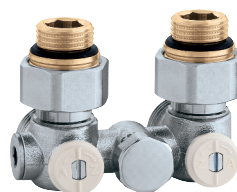

Valve for panel radiators with built-in thermostatic valve unit. One-pipe angled version (wall connections) with 1/2" F radiator connections.
With adjustable by-pass.
With non-return device.
Max. working pressure: 10 bar.
Max. working temperature: 100°C.

Code	Radiator connection	Pipe connection		
301341	1/2" M	3/4"	1	25

VALVES FOR PANEL RADIATORS



3010

Valve for panel radiators with built-in thermostatic valve unit. Single valve straight version (floor connections) with 3/4" M radiator connections. Max. working pressure: 10 bar. Max. working temperature: 100°C.

Code	Radiator connection	Pipe connection		
301050	3/4" F	3/4"	1	25



3014

Straight single valve for panel radiators with built-in thermostatic valve unit (floor connections) with 1/2" F radiator connections. Max. working pressure: 10 bar. Max. working temperature: 100°C.

Code	Radiator connection	Pipe connection		
301440	1/2" M	3/4"	1	50

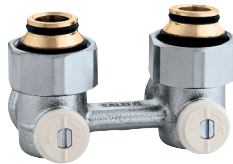

3011

Valve for panel radiators with built-in thermostatic valve unit. Single valve angled version (wall connections) with 3/4" M radiator connections. Max. working pressure: 10 bar. Max. working temperature: 100°C.

Code	Radiator connection	Pipe connection		
301150	3/4" F	3/4"	1	25



3015

Angled single valve for panel radiators with built-in thermostatic valve unit (wall connections) with 1/2" F radiator connections. Max. working pressure: 10 bar. Max. working temperature: 100°C.

Code	Radiator connection	Pipe connection		
301540	1/2" M	3/4"	1	50

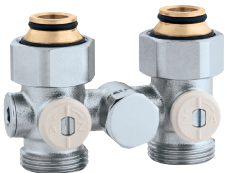

3012

Valve for panel radiators with built-in thermostatic valve unit. One-pipe straight version (floor connections) with 3/4" M radiator connections. With adjustable by-pass. **With non-return device.** Max. working pressure: 10 bar. Max. working temperature: 100°C.

Code	Radiator connection	Pipe connection		
301250	3/4" F	3/4"	1	25



3014

Straight single valve for panel radiators with built-in thermostatic valve unit (floor connections) with 3/4" M radiator connections. Max. working pressure: 10 bar. Max. working temperature: 100°C.

Code	Radiator connection	Pipe connection		
301450	3/4" F	3/4"	1	50

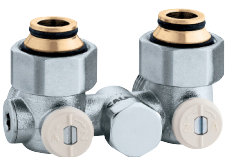

3013

Valve for panel radiators with built-in thermostatic valve unit. One-pipe angled version (wall connections) with 3/4" M radiator connections. With adjustable by-pass. **With non-return device.** Max. working pressure: 10 bar. Max. working temperature: 100°C.

Code	Radiator connection	Pipe connection		
301350	3/4" F	3/4"	1	25



3015

Angled single valve for panel radiators with built-in thermostatic valve unit (wall connections) with 3/4" M radiator connections. Max. working pressure: 10 bar. Max. working temperature: 100°C.

Code	Radiator connection	Pipe connection		
301550	3/4" F	3/4"	1	50

DISTRIBUTION MANIFOLDS, ZONE VALVES, BOXES AND ACCESSORIES

This diagram is just an indication

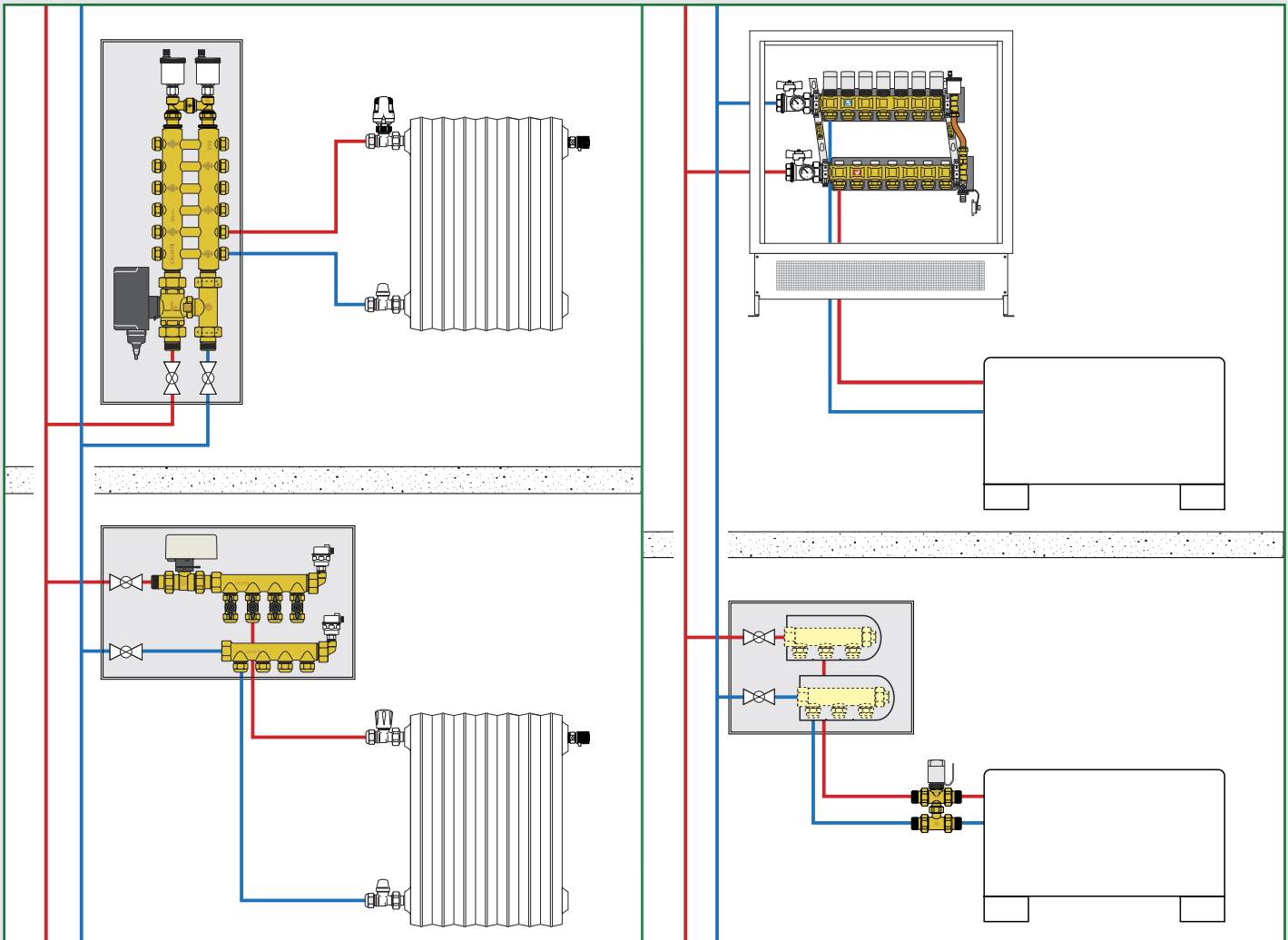

4

- Inspection wall boxes
- Motorised ball zone valves
- Thermo-electric zone piston valves
- Motorised zone valves with spring return
- Motorised ball valves
- Motorised valves for central heating systems
- Motorised butterfly valves
- Single and dual distribution manifolds
- Single distribution manifolds for air conditioning systems
- Distribution manifolds with shut-off and pre-regulating valves
- Thermo-electric actuators
- Accessories and fittings for distribution manifolds

PLASTIC INSPECTION WALL BOXES



361

Plastic inspection wall port, with zinc plated sheet steel frame. White colour RAL 9010.

Code	Dim. (h x w)		
361032	320 x 250	1	5
361050	500 x 250	1	10



360

Plastic inspection wall box. For distribution manifolds 349, 350, 592 and 354 series. Version with foldable side walls. White colour RAL 9010.

Code	Dim. (h x w x d)		
360032	320 x 250 x 90	1	10
360050	500 x 250 x 90	1	10



363

tech. broch. 01091

Inspection wall port and frame in plastic. Ventilated. White colour RAL 9010.

Code	Dim. (h x w)		
363036	360 x 270	1	10
363056	560 x 330	1	5
363073	730 x 360	1	5

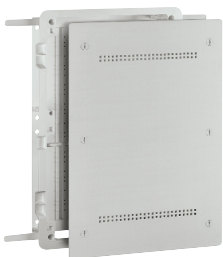

362

tech. broch. 01091

Plastic inspection wall box. For dual distribution manifolds 356, 357 series and single distribution manifolds 349, 350, 592 and 354 series. Ventilated. Equipped with lateral protections. Adjustable depth from 100 to 80 mm. White colour RAL 9010.

Code	Dim. (h x w x d)		
362036	360 x 270 x 100/80	1	10
362056	560 x 330 x 100/80	1	5
362073	730 x 360 x 100/80	1	5



360

tech. broch. 01091

Pair of mounting brackets for 3/4" and 1" dual distribution manifolds 356, 356 IS and 357 series. For plastic inspection boxes 360 and 362 series.

Code		
360003	1	-



360

Pair of stainless steel mounting brackets for distribution manifolds 354 series. For plastic inspection boxes 360 and 362 series.

Code		
360210	1	10



360

tech. broch. 01091

Mounting brackets for 1" single distribution manifolds 350 and 592 series, for 3/4" and 1" distribution manifolds 351 and 598 series. For plastic inspection boxes 360 and 362 series. In package:
- N. 2 long brackets
- N. 2 short brackets.

Code		
360001	1	10



360

tech. broch. 01091

Mounting brackets for 3/4" single distribution manifolds 349, 350 and 592 series. For plastic inspection boxes 360 and 362 series. In package:
- N. 2 long brackets
- N. 2 short brackets.

Code		
360002	1	10



362

tech. broch. 01091

Mounting brackets for dual distribution manifolds 356 and 357 series. For plastic inspection boxes 362 series.

Code		
362001	1	10

SHEET STEEL INSPECTION WALL BOXES



5890

Recessed inspection wall port with frame.
In zinc plated sheet steel.

Code	Dim. (h x w)		
589003	370 x 275	1	10
589005	540 x 275	1	10



5891

Recessed inspection wall box with frame.
For dual distribution manifolds 356 series.
In zinc plated sheet steel.
Adjustable depth 70, 90 or 110 mm.
Supplied with manifold mounting bracket.

Code	Dim. (h x w x d)		
589103	370 x 275 x 70/90/110	1	3
589105	540 x 275 x 70/90/110	1	3



659

tech. broch. 01144

Inspection wall box for distribution manifolds 349, 350, 592, 662, 663, 671, 668...S1, 664 and 665 series.
Wall or floor installations (with 660 series).
Closure with a push-fit clamp.
In painted sheet steel.
Adjustable depth from 110 to 140 mm.

Code	Dim. (h x w x d)		
659044	500 x 400 x 110-140	1	-
659064	500 x 600 x 110-140	1	-
659084	500 x 800 x 110-140	1	-
659104	500 x 1000 x 110-140	1	-
659124	500 x 1200 x 110-140	1	-



659

tech. broch. 01144

Inspection wall port with frame.
In painted sheet steel.

Code			
659304	for 659044	1	-
659306	for 659064	1	-
659308	for 659084	1	-
659310	for 659104	1	-
659312	for 659124	1	-



659

tech. broch. 01144

Inspection wall box for distribution manifolds 349, 350, 592, 662, 671, 664 and 665 series.
Complete with specific support for manifold brackets.
Closure with a push-fit clamp.
In painted sheet steel.
Adjustable depth from 80 to 120 mm.

Code	Dim. (h x w x d)		
659045	500 x 400 x 80-120	1	-
659065	500 x 600 x 80-120	1	-
659085	500 x 800 x 80-120	1	-
659105	500 x 1000 x 80-120	1	-



659

tech. broch. 01144

Inspection wall port with frame.
In painted sheet steel.

Code			
659504	for 659045	1	-
659506	for 659065	1	-
659508	for 659085	1	-
659510	for 659105	1	-



658

Pair of mounting brackets for distribution manifolds 592, 350 and 351 series.
With insulating clamps, screws and wall anchors.
To be used with boxes 659 series or directly wall mounted.

Code			
658000		1	20

NEW



658

Pair of steel mounting brackets for distribution manifolds 662 and 664 series.
To be used with boxes code 659..5 or directly wall mounted.

Code			
658101		1	-



658

Pair of mounting brackets for distribution manifolds 663 and 668...S1 series.
With screws and wall anchors.
To be used with boxes 659 series or directly wall mounted.

Code			
658100		1	20



658

Pair of mounting brackets for 3/4" and 1" distribution manifolds 350 and 592 series.
With clamps and screws.
To connect manifolds to zone valves.
To be used with boxes 659 series.

Code			
658200		1	-

MOTORISED BALL ZONE VALVES



6460

tech. broch. 01015

Actuator for ball zone valves 6470, 6480 and 6489 series.
Supply: 230 V (ac) or 24 V (ac).
With auxiliary microswitch.
Power consumption: 4 VA.
Auxiliary microswitch contact rating: 0,8 A (230 V) - 1,3 A (24 V).
Operating time: 50 s.
Max. ambient temperature: 55°C.
Protection class: IP 43.



Code	Supply voltage V		
646002	230 (±20%)	1	10
646004	24 (±10%)	1	10



6470

tech. broch. 01015

Two-way ball zone valve.
Max. working pressure: 10 bar.
Max. Δp: 10 bar.
Temperature range: -5-110°C.
New O-Ring seal.

Code		Kv (m ³ /h)		
647040	1/2"	17,00	1	10
647050	3/4"	17,27	1	10
647060	1"	36,58	1	5
647070	1 1/4"	39,50	1	5



6480

tech. broch. 01015

Three-way ball zone valve.
3/4" F by-pass connection.
Max. working pressure: 10 bar.
Max. Δp: 10 bar.
Temperature range: -5-110°C.
New O-Ring seal.

Code		Kv (m ³ /h) straight	Kv (m ³ /h) by-pass		
648040	1/2"	14,10	2,45	1	10
648050	3/4"	14,43	2,50	1	10
648060	1"	33,52	3,60	1	5
648070	1 1/4"	36,00	3,80	1	5

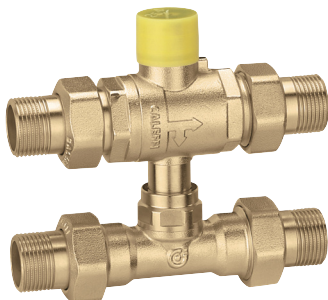

6489

tech. broch. 01015

Three-way ball zone valve with by-pass tee.
Max. working pressure: 10 bar.
Max. Δp: 10 bar.
Temperature range: -5-110°C.
Tee complete with nozzle U6.
Adjustable outlet centre distance from 49 to 63 mm.
New O-Ring seal.

Code		Kv (m ³ /h) straight	Kv (m ³ /h) by-pass		
648950	3/4"	14,43	1,20	1	10

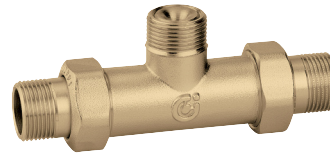

6490

tech. broch. 01015

Balanced by-pass tee.
For ball zone valves 6480 series.
Max. working pressure: 10 bar.
Temperature range: -5-110°C.
New O-Ring seal.

Code		Kv (m ³ /h) tee + valve in by-pass		
649040	1/2" without nozzle	2,20	1	10
649044	1/2" U4	0,78	1	10
649046	1/2" U6	1,16	1	10
649048	1/2" U8	1,40	1	10
649050	3/4" without nozzle	2,25	1	10
649054	3/4" U4	0,87	1	10
649056	3/4" U6	1,20	1	10
649058	3/4" U8	1,50	1	10
649060	1" without nozzle	3,25	1	5
649064	1" U4	1,90	1	5
649066	1" U6	2,50	1	5
649068	1" U8	3,25	1	5
649070	1 1/4" without nozzle	3,40	1	5

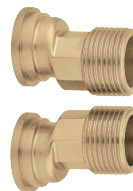

6480

tech. broch. 01015

Pair of off-centre fittings for connecting zone valves unit 6480, 633 series and respective by-pass tee 6490, 635 series to any dual manifold with outlet centre distance between 50 and 70 mm.

Code			
648005	3/4"	1	-
648006	1"	1	-



6480

tech. broch. 01015

Off-centre kit connecting to the zone valves unit 6480, 6453, 633 series and respective by-pass tee 6490, 6459, 635 series, for installation in manifold box 659 and 661 series and connection to distribution manifolds 349, 350, 592 and 668...S1 series.
Max. working pressure: 10 bar.
Temperature range: -5-110°C.

Code		
648018	1	10

Wiring diagram for 6460 series, two point actuator with internal relays, valve in closed position

- R relay
- MC1 opening end microswitch.
- MC2 closing end microswitch.
- MC3 free auxiliary microswitch. With the valve open, the free microswitch contacts are closed.

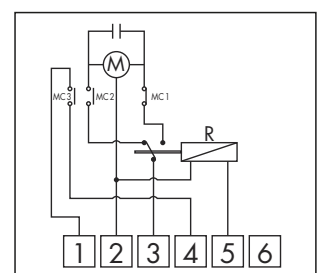

MOTORIZED BALL ZONE VALVES FOR AIR-CONDITIONING SYSTEMS



6452

tech. broch. 01199

Motorised two-way ball zone valve, for air-conditioning systems. With manual opening lever. **With insulation.** Max. working pressure: 10 bar. Max. Δp: 10 bar. Temperature range: -10–110°C.

With auxiliary microswitch.

Supply: 230 V (ac) o 24 V (ac). Power consumption: 6 VA. Auxiliary microswitch contact rating: 6 (2) A (230 V). Ambient temperature range: -10–55°C. Protection class: IP 65. Operating time: 50 s (90° rotation). Length of supply cable: 80 cm.



Code	Supply voltage V	Kv (m ³ /h)		
645242	1/2"	230	17,00	1 -
645252	3/4"	230	17,27	1 -
645262	1"	230	36,58	1 -
645272	1 1/4"	230	39,50	1 -
645244	1/2"	24	17,00	1 -
645254	3/4"	24	17,27	1 -
645264	1"	24	36,58	1 -
645274	1 1/4"	24	39,50	1 -



6453

tech. broch. 01199

Motorised three-way ball zone valve, for air-conditioning systems. With manual opening lever. **With insulation.** Max. working pressure: 10 bar. Max. Δp: 10 bar. Temperature range: -10–110°C.

With auxiliary microswitch.

Supply: 230 V (ac) o 24 V (ac). Power consumption: 6 VA. Auxiliary microswitch contact rating: 6 (2) A (230 V). Ambient temperature range: -10–55°C. Protection class: IP 65. Operating time: 50 s (90° rotation). Length of supply cable: 80 cm.



Code	Supply voltage V	Kv (m ³ /h) straight	Kv (m ³ /h) by-pass		
645342	1/2"	230	14,10	2,45	1 -
645352	3/4"	230	14,43	2,50	1 -
645362	1"	230	33,52	3,60	1 -
645372	1 1/4"	230	36,00	3,80	1 -
645344	1/2"	24	14,10	2,45	1 -
645354	3/4"	24	14,43	2,50	1 -
645364	1"	24	33,52	3,60	1 -
645374	1 1/4"	24	36,00	3,80	1 -



6459

tech. broch. 01199

By-pass tee. For motorised ball zone valves 6453 series. **With insulation.** Max. working pressure: 10 bar. Max. Δp: 10 bar. Temperature range: -10–110°C.

Code		Kv (m ³ /h) tee + valve in by-pass		
645940	1/2"	without nozzle	2,20	1 -
645950	3/4"	without nozzle	2,25	1 -
645960	1"	without nozzle	3,25	1 -
645970	1 1/4"	without nozzle	3,40	1 -

6450

tech. broch. 01199

Spare actuator for motorised ball zone valves 6452 and 6453 series. Supply: 230 V (ac) or 24 V (ac).



Code	Supply voltage V		
645002	230	1	10
645004	24	1	10



6459

tech. broch. 01199

Shell insulation for motorised ball zone valves 6453 series with by-pass tee 6459 and 6490 series. Fitted for manifolds 356... IS series.

Code			
645901	1/2" - 3/4"	1	-
645900	1" - 1 1/4"	1	-

Wiring diagram for 6452 and 6453 series valves, two point actuator with internal relays, valve in closed position

- R relay
- MC1 opening end microswitch.
- MC2 closing end microswitch.
- MICRO AUX free auxiliary microswitch.

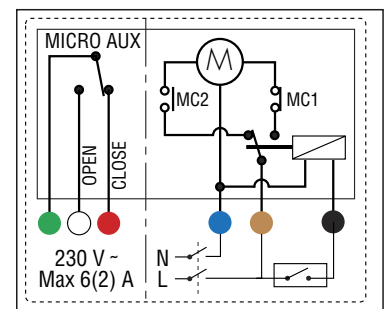

MOTORISED BALL ZONE VALVES

6442

tech. broch. 01131



Motorised two-way ball zone valve.
Max. working pressure: 10 bar.
Max. Δp: 10 bar.
Temperature range: -5–110°C.

Equipped with actuator with 3-contact control. With auxiliary microswitch.

Supply: 230 V (ac) or 24 V (ac).
Power consumption: 4 VA.
Auxiliary microswitch contact rating: 0,8 A (230 V).
Ambient temperature range: 0–55°C.
Protection class: IP 44 (vertical stem), IP 40 (horizontal stem).
Operating time: 40 s (90° rotation).
Lenght of supply cable: 100 cm.



Code	Supply voltage V	Kv (m ³ /h)		
644242	1/2"	230	11,1	1 10
644252	3/4"	230	11,1	1 10
644262	1"	230	11,1	1 10
644244	1/2"	24	11,1	1 10
644254	3/4"	24	11,1	1 10
644264	1"	24	11,1	1 10

6444

tech. broch. 01131



Motorised three-way ball zone valve with telescopic by-pass tee.
Max. working pressure: 10 bar.
Max. Δp: 10 bar.
Temperature range: -5–110°C.
Tee complete with nozzle U6.

Adjustable outlet centre distance from 49 to 63 mm.

Equipped with actuator with 3-contact control. With auxiliary microswitch.

Supply: 230 V (ac) or 24 V (ac).
Power consumption: 4 VA.
Auxiliary microswitch contact rating: 0,8 A (230 V).
Ambient temperature range: 0–55°C.
Protection class: IP 44 (vertical stem), IP 40 (horizontal stem).
Operating time: 40 s (90° rotation).
Lenght of supply cable: 100 cm.



Code	Supply voltage V	Kv (m ³ /h) straight	Kv (m ³ /h) by-pass		
644442	1/2"	230	10,3	1,2	1 5
644452	3/4"	230	10,3	1,2	1 5
644462	1"	230	10,3	1,2	1 5
644444	1/2"	24	10,3	1,2	1 5
644454	3/4"	24	10,3	1,2	1 5
644464	1"	24	10,3	1,2	1 5

6443.. 3BY

tech. broch. 01131



Motorised three-way ball zone valve, by-pass version.
Max. working pressure: 10 bar.
Max. Δp: 10 bar.
Temperature range: -5–110°C.

Equipped with actuator with 3-contact control. With auxiliary microswitch.

Supply: 230 V (ac) or 24 V (ac).
Power consumption: 4 VA.
Auxiliary microswitch contact rating: 0,8 A (230 V).
Ambient temperature range: 0–55°C.
Protection class: IP 44 (vertical stem), IP 40 (horizontal stem).
Operating time: 40 s (90° rotation).
Lenght of supply cable: 100 cm.



Code	Supply voltage V	Kv (m ³ /h) straight	Kv (m ³ /h) by-pass		
644342 3BY	1/2"	230	10,3	1,8	1 5
644352 3BY	3/4"	230	10,3	1,8	1 5
644362 3BY	1"	230	10,3	1,8	1 5
644344 3BY	1/2"	24	10,3	1,8	1 5
644354 3BY	3/4"	24	10,3	1,8	1 5
644364 3BY	1"	24	10,3	1,8	1 5

6440

tech. broch. 01131



3-contact control spare actuator for motorised ball zone valves 6442, 6443..3BY and 6444 series.
Operating time 40 s.
Supply: 230 V (ac) or 24 V (ac).



Code	Supply voltage V		
644002	230	1	10
644004	24	1	10

Wiring diagram for valves 6442 - 6443..3BY - 6444 series with 3-contact actuator

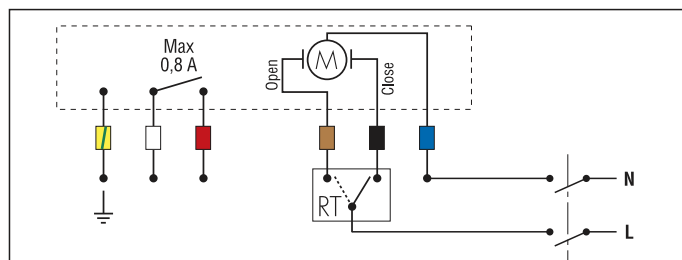

THERMO-ELECTRIC PISTON ZONE VALVES



632 *tech. broch. 01039*
 Two-way piston zone valve.
 Max. working pressure: 10 bar.
 Max. Δp: 1 bar.
 Temperature range: -5-95°C.

Code		Kv (m ³ /h)		
632400	1/2"	5,10	1	5
632500	3/4"	6,27	1	5
632600	1"	6,38	1	5

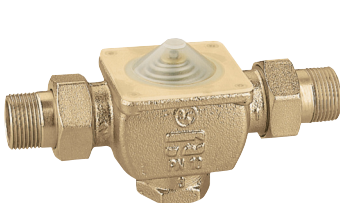

633 *tech. broch. 01039*
 Three-way piston zone valve.
 3/4" F by-pass connection.
 Max. working pressure: 10 bar.
 Max. Δp: 1 bar.
 Temperature range: -5-95°C.

Code		Kv (m ³ /h) straight	Kv (m ³ /h) by-pass		
633400	1/2"	4,99	4,33	1	5
633500	3/4"	6,19	4,91	1	5
633600	1"	6,45	5,30	1	5



635 *tech. broch. 01039*
 Balanced by-pass tee.
 For zone valves 633 series.
 Max. working pressure: 10 bar.
 Max. Δp: 1 bar.
 Temperature range: -5-95°C.

Code			Kv (m ³ /h) tee + valve in by-pass		
635440	1/2"	U4	0,96	1	5
635460	1/2"	U6	1,32	1	5
635480	1/2"	U8	1,73	1	5
635540	3/4"	U4	0,98	1	5
635560	3/4"	U6	1,36	1	5
635580	3/4"	U8	1,79	1	5
635640	1"	U4	1,02	1	5
635660	1"	U6	1,43	1	5
635680	1"	U8	1,88	1	5

Installation

1. The 2-way zone valve 632 series should be installed on the circuit flow pipe. The 2-way valve cannot be converted into 3-way valve by removing the plug.
2. The 3-way zone valve 633 series should be installed on the circuit return pipe. The 3-way valve cannot be converted into 2-way valve by applying a plug.

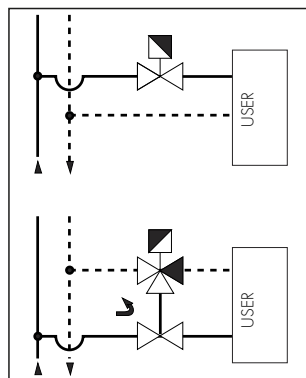

630 *tech. broch. 01039*
 Thermo-electric actuator.
 For zone valves 632 and 633 series.
 Normally closed.
 Supply: 230 V (ac) or 24 V (ac).
With auxiliary microswitch.
 Power consumption: - starting 11 W.
 - operating 4 W.
 Auxiliary microswitch contact rating:
 6 (3) A (230 V).
 Max. ambient temperature: 55°C.
 Protection class:
 IP 44 (vertical stem),
 IP 42 (horizontal stem).



Code	Supply voltage V		
630012	230	1	10
630014	24	1	10
630002	230 without auxiliary microswitch	1	10
630004	24 without auxiliary microswitch	1	10



630 *tech. broch. 01039*
 Thermo-electric actuator.
 For zone valves 632 and 633 series.
 Normally closed.
 Supply: 230 V (ac) or 24 V (ac).
With manual actuator and auxiliary microswitch.
 Power consumption: - starting 11 W.
 - operating 4 W.
 Auxiliary microswitch contact rating:
 6 (3) A (230 V).
 Max. ambient temperature: 55°C.
 Protection class: IP 20.



Code	Supply voltage V		
630112	230	1	10
630114	24	1	10
630102	230 without auxiliary microswitch	1	10
630104	24 without auxiliary microswitch	1	10

Wiring diagram for piston zone valves 632 and 633 series with thermo-electric actuator

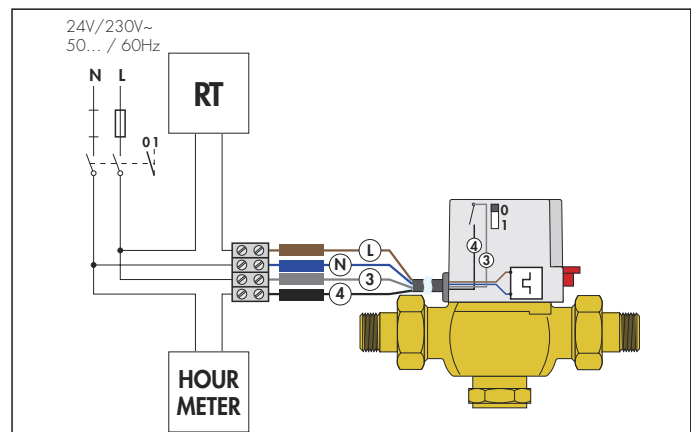

THERMO-ELECTRIC PISTON ZONE VALVES

NEW



676

tech. broch. 01343

Two-way zone valve with high flow rate. Fitted for thermo-electric actuators 6563, 6561, 6562 and 6564 series. Max. working pressure: 10 bar. Max. Δp: 2,5 bar. Temperature range: 0–95°C. PATENT PENDING.

Code		Kv (m ³ /h)		
676500	1"	4,77	1	20



676

tech. broch. 01072

Two-way zone valve. Fitted for thermo-electric actuators 6563, 6561, 6562 and 6564 series. Max. working pressure: 10 bar. Max. Δp: 1,2 bar. Temperature range: 0–95°C.

Code		Kv (m ³ /h)		
676040	1/2"	3,7	1	10
676050	3/4"	3,7	1	10
676060	1"	3,7	1	10



677

tech. broch. 01072

Three-way zone valve. Fitted for thermo-electric actuators 6563, 6561, 6562 and 6564 series. Max. working pressure: 10 bar. Max. Δp: 1,2 bar. Temperature range: 0–95°C.

Code		Kv (m ³ /h) straight	Kv (m ³ /h) by-pass		
677040	1/2"	3,7	1,0	1	10
677050	3/4"	3,7	1,0	1	10
677060	1"	3,7	1,0	1	10



678

tech. broch. 01072

Three-way zone valve with by-pass tee. Fitted for thermo-electric actuators 6563, 6561, 6562 and 6564 series. Max. working pressure: 10 bar. Max. Δp: 1,2 bar. Temperature range: 0–95°C. Tee complete with nozzle U6. **Adjustable outlet centre distance from 49 to 63 mm.**

Code		Kv (m ³ /h) straight	Kv (m ³ /h) by-pass		
678040	1/2"	3,7	1,0	1	10
678050	3/4"	3,7	1,0	1	10
678060	1"	3,7	1,0	1	10



6563

tech. broch. 01142

Thermo-electric actuator. With manual opening and position indicator. Normally closed. **With auxiliary microswitch.** Supply: 230 V (ac) or 24 V (ac)/(dc). Power consumption: 3 W. Starting current: ≤ 1 A. Auxiliary microswitch contact rating: 0,8 A (230 V). Ambient temperature range: 0–50°C. Protection class: IP 40.

Code	Supply voltage V			
656312	230		1	10
656314	24		1	10
656302	230	without auxiliary microswitch	1	10
656304	24	without auxiliary microswitch	1	10



6561

tech. broch. 01042

Thermo-electric actuator. Normally closed. **With auxiliary microswitch.** Supply: 230 V (ac) or 24 V (ac)/(dc). Auxiliary microswitch contact rating: 0,8 A (230 V). Power consumption: 3 W. Starting current: ≤ 1 A. Ambient temperature range: 0–50°C. Protection class: IP 44 (vertical stem).

Code	Supply voltage V			
656112	230		1	10
656114	24		1	10
656102	230	without auxiliary microswitch	1	10
656104	24	without auxiliary microswitch	1	10



6562

tech. broch. 01198

Thermo-electric actuator. With opening position indicator. **Quick-coupling installation, with a clip adapter.** Normally closed. **With auxiliary microswitch.** Supply: 230 V (ac) or 24 V (ac)/(dc). Auxiliary microswitch contact rating: 0,8 A (230 V). Power consumption: 3 W. Starting current: ≤ 1 A. Ambient temperature range: 0–50°C. Protection class: IP 54.

Code	Supply voltage V			
656212	230		1	10
656214	24		1	10
656202	230	without auxiliary microswitch	1	10
656204	24	without auxiliary microswitch	1	10



6564

tech. broch. 01198

Thermo-electric actuator with low power consumption. With opening position indicator. **Quick-coupling installation, with a clip adapter.** Normally closed. **With auxiliary microswitch.** Supply: 230 V (ac) or 24 V (ac)/(dc). Auxiliary microswitch contact rating: 0,8 A (230 V). Power consumption: 3 W. Starting current: ≤ 250 mA. Ambient temperature range: 0–50°C. Protection class: IP 54.

Code	Supply voltage V			
656412	230		1	10
656414	24		1	10
656402	230	without auxiliary microswitch	1	10
656404	24	without auxiliary microswitch	1	10

MOTORIZED ZONE VALVES WITH SPRING RETURN

642
Zone™

tech. broch. 01115



Motorised two-way zone valve.
Normally closed.
With auxiliary microswitch.
Supply: 230 V (ac).
Power consumption: 6,5 W; 7 VA.
Auxiliary microswitch contact rating:
0,8 A (230 V).
Opening time: 70–75 s.
Closing time: 5–7 s.
Protection class: IP 20.
Max. ambient temperature: 40°C.
Max. working pressure: 16 bar.
Temperature range: 0–90°C.
Cable length: 95 cm.



Code	Kv (m³/h)	Max. Δp (bar)		
642042	1/2"	2,5	2,10	1 10
642052	3/4"	4,5	1,50	1 10
642062	1"	6	1,00	1 10

643
Zone™

tech. broch. 01115



Motorised three-way zone valve.
Normally closed.
With auxiliary microswitch.
Supply: 230 V (ac).
Power consumption: 6,5 W; 7 VA.
Auxiliary microswitch contact rating:
0,8 A (230 V).
Opening time: 70–75 s.
Closing time: 5–7 s.
Protection class: IP 20.
Max. ambient temperature: 40°C.
Max. working pressure: 16 bar.
Temperature range: 0–90°C.
Cable length: 95 cm.



Code	Kv (m³/h)	Δp max (bar)		
643042	1/2"	2,5	2,10	1 10
643052	3/4"	4,5	1,50	1 10
643062	1"	6	1,00	1 10

641

tech. broch. 01115



Spare actuator for motorised zone valves
642 and 643 series.
Supply: 230 V (ac).



Code		
641002	1	-

Removable actuator

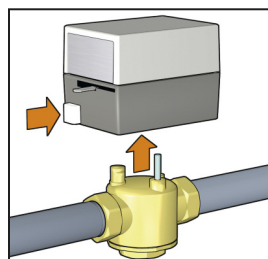
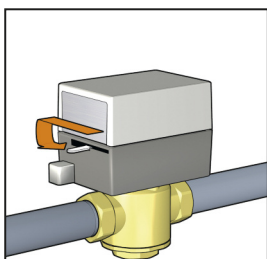

Installation

The 3-way valve cannot be converted into 2-way valve and viceversa.

2-way valve installed on the flow

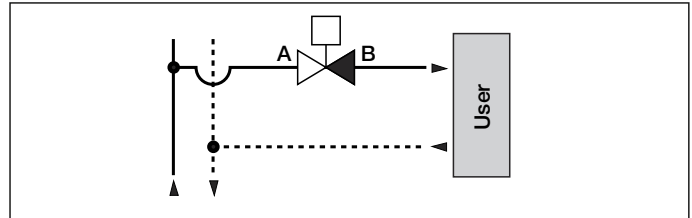

2-way valve installed on the return

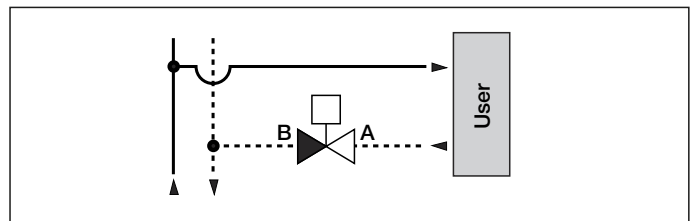

3-way valve installed on the flow with diverting position and ON/OFF use mode

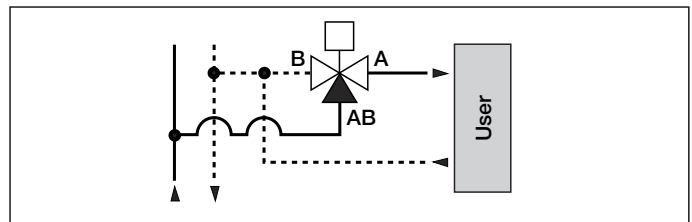

3-way valve installed on the return with mixing position and ON/OFF use mode

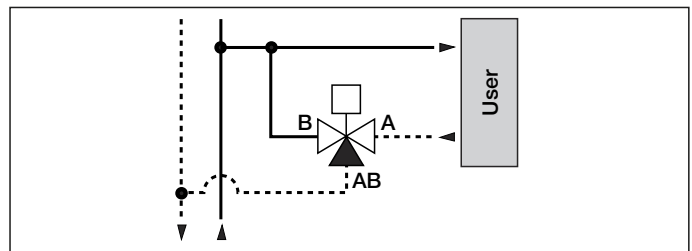

Wiring diagram for spring return valves 642 and 643 series

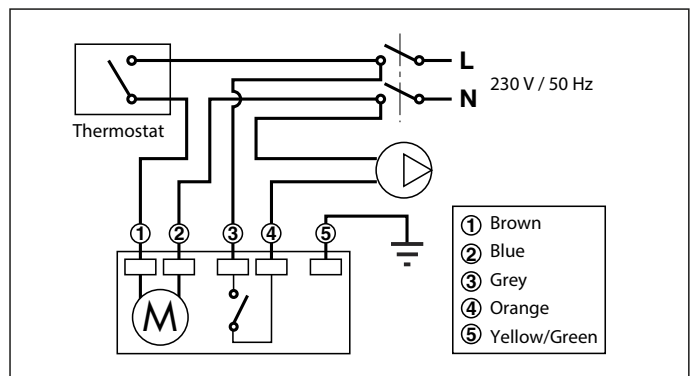

MOTORIZED TWO-WAY BALL VALVES

Operating time 10 s



6442

tech. broch. 01131

Motorised two-way ball valve.
Max. working pressure: 10 bar.
Max. Δp: 10 bar.
Temperature range: -5–110°C.

Equipped with actuator with 3-contact control.

With auxiliary microswitch.
Supply: 230 V (ac) or 24 V (ac).
Power consumption: 8 VA.
Auxiliary microswitch contact rating: 0,8 A (230 V).
Ambient temperature range: 0–55°C.
Protection class: IP 44 (vertical stem).
IP 40 (horizontal stem).

Operating time: 10 s (rotation 90°).
Cable length: 100 cm.



Code	Supply voltage V	Kv (m³/h)		
644246	1/2" 230	11,1	1	10
644256	3/4" 230	11,1	1	10
644248	1/2" 24	11,1	1	10
644258	3/4" 24	11,1	1	10



6440

tech. broch. 01132

3-contact control spare actuator for motorised ball zone valves 6442 series.

Operating time 10 s.
Supply: 230 V (ac) or 24 V (ac).



Code	Supply voltage V		
644012	230	1	10
644014	24	1	10

Wiring diagram for valves 6442 and 6443 series, with 3-contact actuator

Connection diagram for room thermostat (RT) and electric supply.

The illustrated connection makes it possible to open and close the valve according to the signal provided by the 3-contact room thermostat.

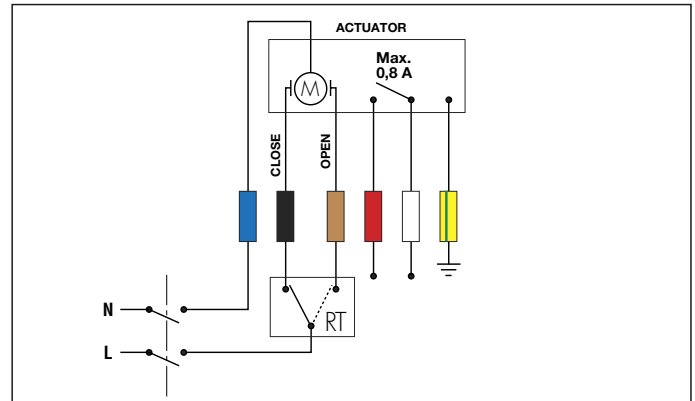

Connection diagram - with ON/OFF switch device

The illustrated connection makes it possible to open and close the valve when the switch allows, using an intermediate relay device.

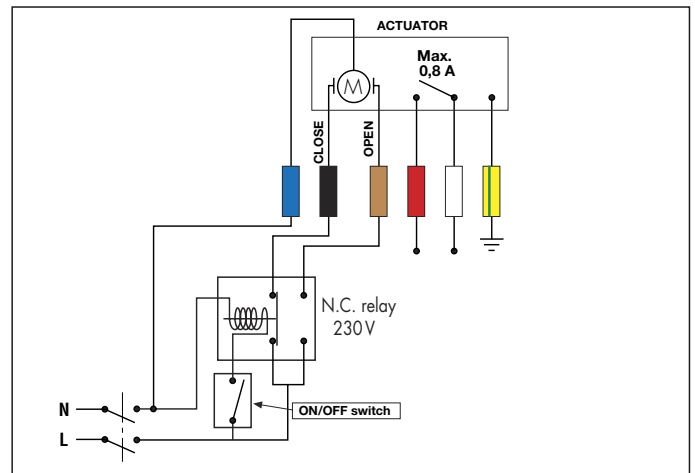

Pump disconnection diagram when no zone is in operation.

This diagram, using the auxiliary microswitch, allows the pump to be deactivated when the diverter valve used as a zone valve is closed.

If the pump has a power consumption level over 0,8 A (170 VA), an intermediate contactor must be used.

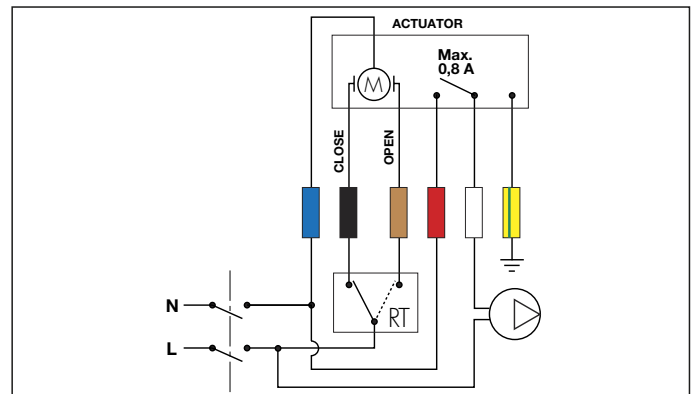

MOTORIZED THREE-WAY BALL DIVERTER VALVES

Operating time 10 s

Operating time 40 s



6443 tech. broch. 01132
 Motorised three-way diverter valve.
 Max. working pressure: 10 bar.
 Max. Δp: 10 bar.
 Temperature range: -5–110°C.
Equipped with actuator with 3-contact control. With auxiliary microswitch.
 Supply: 230 V (ac) or 24 V (ac).
 Power consumption: 8 VA.
 Auxiliary microswitch contact rating: 0,8 A (230 V).
 Ambient temperature range: 0–55°C.
 Protection class: IP 44 (vertical stem). IP 40 (horizontal stem).
Operating time: 10 s (rotation 90°).
 Cable length: 100 cm.



6443 tech. broch. 01132
 Motorised three-way diverter valve.
 Max. working pressure: 10 bar.
 Max. Δp: 10 bar.
 Temperature range: -5–110°C.
Equipped with actuator with 3-contact control. With auxiliary microswitch.
 Supply: 230 V (ac) or 24 V (ac).
 Power consumption: 4 VA.
 Auxiliary microswitch contact rating: 0,8 A (230 V).
 Ambient temperature range: 0–55°C.
 Protection class: IP 44 (vertical stem). IP 40 (horizontal stem).
Operating time: 40 s (90° rotation).
 Cable length: 100 cm.



Code	Supply voltage V	Kv (m³/h)		
644346	1/2"	230	3,9	1 5
644356	3/4"	230	3,9	1 5
644357	3/4"	230	8,6	1 5
644366	1"	230	9,0	1 5
644348	1/2"	24	3,9	1 5
644358	3/4"	24	3,9	1 5
644359	3/4"	24	8,6	1 5
644368	1"	24	9,0	1 5

Code	Supply voltage V	Kv (m³/h)		
644342	1/2"	230	3,9	1 5
644352	3/4"	230	3,9	1 5
644353	3/4"	230	8,6	1 5
644362	1"	230	9,0	1 5
644344	1/2"	24	3,9	1 5
644354	3/4"	24	3,9	1 5
644355	3/4"	24	8,6	1 5
644364	1"	24	9,0	1 5



6440 tech. broch. 01132
 3-contact control spare actuator for motorised ball zone valves 6443 series.
Operating time 10 s.
 Supply: 230 V (ac) or 24 V (ac).



6440 tech. broch. 01132
 3-contact control spare actuator for motorised ball zone valve 6443 series.
Operating time 40 s.
 Supply: 230 V (ac) or 24 V (ac).



Code	Supply voltage V		
644012	230	1	10
644014	24	1	10

Code	Supply voltage V		
644002	230	1	10
644004	24	1	10

Applications

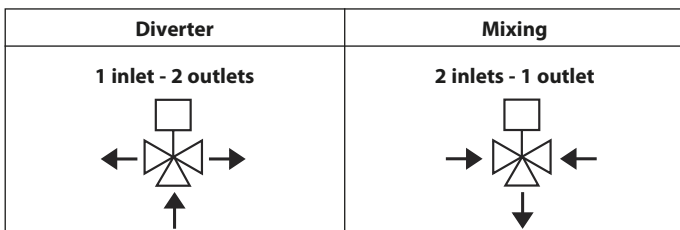

Operating diagram for 6443 series valve
 Operating time 10 s and 40 s - with "T" drilling

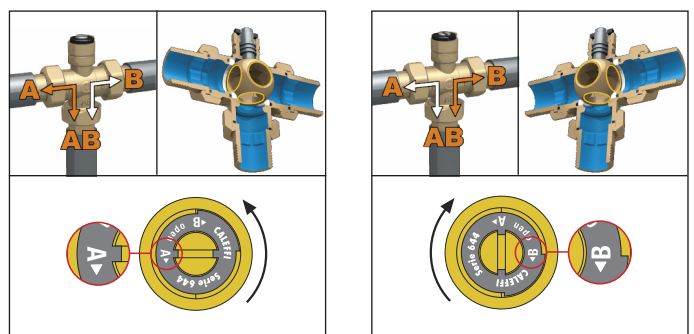

MOTORISED TWO-WAY BALL VALVES FOR HIGH FLOW RATES

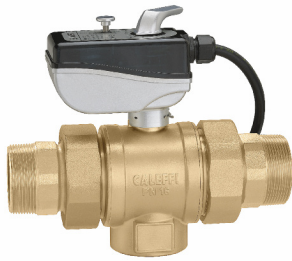

638

tech. broch. 01196

Motorised two-way ball valve.
With auxiliary microswitch.
 Supply: 230 V (ac) or 24 V (ac).
 Max. working pressure: 16 bar.
 Max. Δp: 10 bar.
 Temperature range: -10–110°C.
 Ambient temperature range: -10–55°C.
 Power consumption: 6 VA.
 Auxiliary microswitch contact rating:
 6 (2) A - 230 V (ac).
 Protection class: IP 65.
 Operating time: 50 s (90° rotation).



Code	Actuator torque (N-m)	Supply voltage V	Kv (m³/h)		
638052	3/4"	15	230	17	1 -
638062	1"	15	230	36,5	1 -
638072	1 1/4"	15	230	48	1 -
638082	1 1/2"	15	230	77	1 -
638092	2"	15	230	140	1 -
638054	3/4"	15	24	17	1 -
638064	1"	15	24	36,5	1 -
638074	1 1/4"	15	24	48	1 -
638084	1 1/2"	15	24	77	1 -
638094	2"	15	24	140	1 -

Spare actuators for motorised two-way valves 638 series. 90° rotation. Supply: 230 V (ac) or 24 V (ac).



Code	Supply voltage V		
638012	230	1	-
638014	24	1	-

Wiring diagram for two-way and three-way ball valves 638 series with 3-contact actuator

Internal diagram with valve in the following position:
 - Closed, for two-way valve.
 - Port A closed for three-way valves.

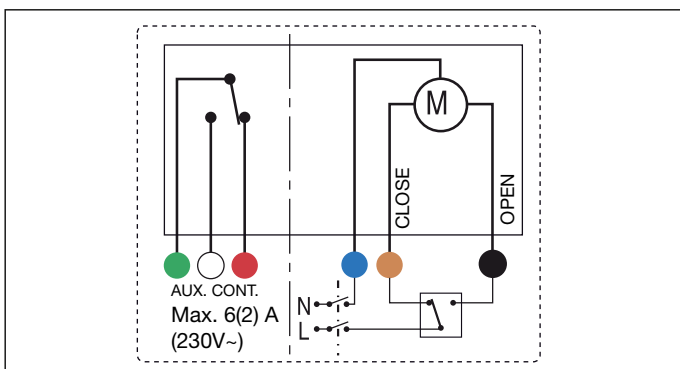

Insulation kit for heating and air conditioning systems. Medium temperature range: -10–110°C. For motorised two-way ball valves 638 series.



Code	Use		
CBN638052	3/4"	1	-
CBN638062	1"	1	-
CBN638072	1 1/4"	1	-
CBN638082	1 1/2"-2"	1	-

Insulation kit for heating and air conditioning systems. Medium temperature range: -10–110°C. For motorised three-way ball valves 638 series.



Code	Use		
CBN638053	3/4" with "L" drilling	1	-
CBN638063	1" with "L" drilling	1	-
CBN638073	1 1/4" with "L" drilling	1	-
CBN638083	1 1/2"-2" with "L" drilling	1	-
CBN638153	3/4" with "T" drilling	1	-
CBN638163	1" with "T" drilling	1	-
CBN638173	1 1/4" with "T" drilling	1	-
CBN638183	1 1/2"-2" with "T" drilling	1	-

MOTORISED THREE-WAY BALL VALVES FOR HIGH FLOW RATES

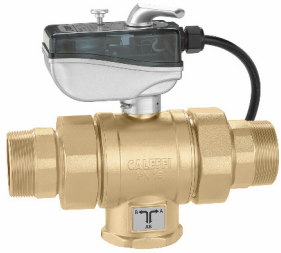

638

tech. broch. 01196

Motorised three-way ball valve.
With auxiliary microswitch.
 Supply: 230 V (ac) or 24 V (ac).
 Max. working pressure: 16 bar.
 Max. Δp: 10 bar.
 Temperature range: -10–110°C.
 Ambient temperature range: -10–55°C.
 Power consumption: 6 VA.
 Auxiliary microswitch contact rating:
 6 (2) A - 230 V (ac).
 Protection class: IP 65.
 Operating time: 50 s (90° rotation).
With "T" drilling. Reduced bore.



Code	Actuator torque (N-m)	Supply voltage V	Kv (m³/h)		
638153	3/4"	15	230	9,5	1 -
638163	1"	15	230	12,9	1 -
638173	1 1/4"	15	230	24,7	1 -
638183	1 1/2"	15	230	47	1 -
638193	2"	15	230	50	1 -
638155	3/4"	15	24	9,5	1 -
638165	1"	15	24	12,9	1 -
638175	1 1/4"	15	24	24,7	1 -
638185	1 1/2"	15	24	47	1 -
638195	2"	15	24	50	1 -

Spare actuators for motorised three-way valves 638 series.
 With "T" drilling. 90° rotation.
 Supply: 230 V (ac) or 24 V (ac).

Code	Supply voltage V		
638012	230	1	-
638014	24	1	-

Applications

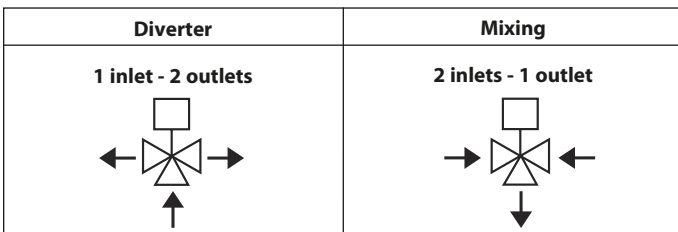

Operating diagram of valves 638 series - "T" drilling

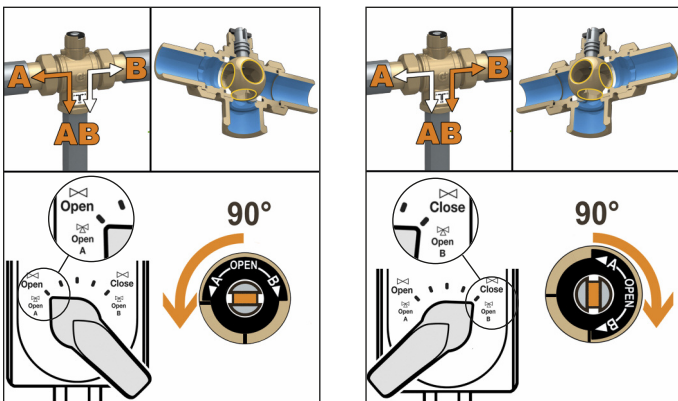

638

tech. broch. 01196

Motorised three-way ball valve.
With auxiliary microswitch.
 Supply: 230 V (ac) or 24 V (ac).
 Max. working pressure: 16 bar.
 Max. Δp: 10 bar.
 Temperature range: -10–110°C.
 Ambient temperature range: -10–55°C.
 Power consumption: 6 VA.
 Auxiliary microswitch contact rating:
 6 (2) A - 230 V (ac).
 Protection class: IP 65.
 Operating time: 100 s (180° rotation).
With "L" drilling. Reduced bore.



Code	Actuator torque (N-m)	Supply voltage V	Kv (m³/h)		
638053	3/4"	15	230	9,9	1 -
638063	1"	15	230	13,4	1 -
638073	1 1/4"	15	230	22,8	1 -
638083	1 1/2"	15	230	44	1 -
638093	2"	15	230	50	1 -
638055	3/4"	15	24	9,9	1 -
638065	1"	15	24	13,4	1 -
638075	1 1/4"	15	24	22,8	1 -
638085	1 1/2"	15	24	44	1 -
638095	2"	15	24	50	1 -

Spare actuators for motorised three-way valves 638 series.
 With "L" drilling. 180° rotation.
 Supply: 230 V (ac) or 24 V (ac).

Code	Supply voltage V		
638412	230	1	-
638414	24	1	-

Applications

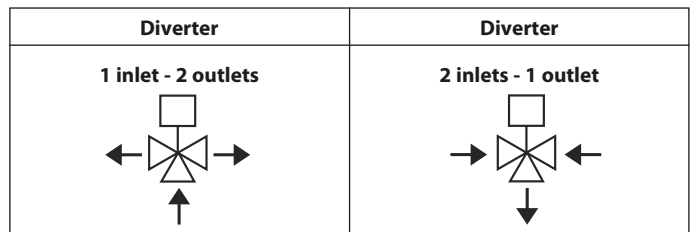

Operating diagram of valves 638 series - "L" drilling

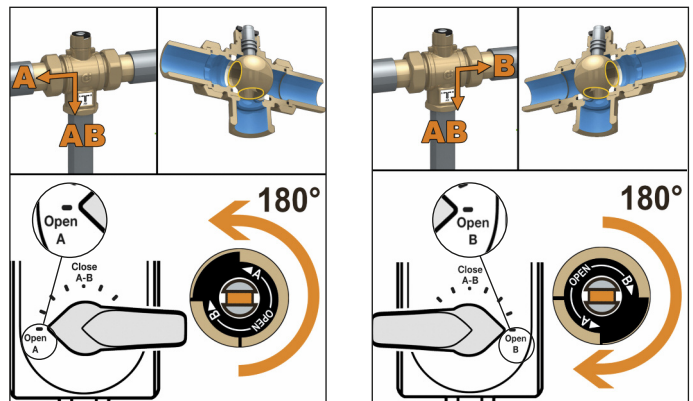

MOTORIZED VALVES FOR CENTRAL HEATING SYSTEMS



637

Motorised two-way ball valve with manual opening. Full bore.
With auxiliary microswitch.
 Supply: 230 V (ac) or 24 V (ac).
 Max. working pressure (static): 2 1/2": 40 bar; 3": 25 bar; 4": 16 bar.
 Max. Δp: 6 bar.
 Temperature range: -10–95°C.
 Max. ambient temperature: 55°C.
 Power consumption: 10,5 VA.
 Auxiliary microswitch contact rating: 16 (6) A - 250 V (ac) - double switch.
 Protection class: IP 65.
 Operating time: 180 s (90° rotation).



Code	Actuator torque (N-m)	Supply voltage V	Kv (m³/h)		
637202	2 1/2"	120	230	170	1 –
637302	3"	120	230	253	1 –
637402	4"	120	230	450	1 –
637204	2 1/2"	120	24	170	1 –
637304	3"	120	24	253	1 –
637404	4"	120	24	450	1 –



636

Motorised three-way piston valve with manual opening. Full bore.
With auxiliary microswitch.
 Supply: 230 V (ac) or 24 V (ac).
 Max. working pressure: 16 bar.
 Max. working temperature: 110°C.
 Auxiliary microswitch contact rating: 3 A (230 V).
 Protection class: IP 44.
 Operating time: 90 s.
It converts into a two-way valve by blanking off the central third way.



Code	Max. Δp bar	Supply voltage V	Kv (m³/h)		
636073	1 1/4"	1,2	230	14	1 –
636083	1 1/2"	1	230	19	1 –
636093	2"	0,9	230	25	1 –
636075	1 1/4"	1,2	24	14	1 –
636085	1 1/2"	1	24	19	1 –
636095	2"	0,9	24	25	1 –



637

Motorised two-way ball valve with manual opening. Full bore. Flanged connections PN 16.
 To be coupled with flat counterflanges EN 1092-1.
With auxiliary microswitch.
 Supply: 230 V (ac) or 24 V (ac).
 Max. working pressure (static): DN 65: 40 bar; DN 80: 25 bar; DN 100: 16 bar.
 Max. Δp: 6 bar.
 Temperature range: -10–95°C.
 Max. ambient temperature: 55°C.
 Power consumption: 10,5 VA.
 Auxiliary microswitch contact rating: 16 (6) A - 250 V (ac) - double switch.
 Protection class: IP 65.
 Operating time: 180 s (90° rotation).



Code	Actuator torque (N-m)	Supply voltage V	Kv (m³/h)		
637212	DN 65	120	230	170	1 –
637312	DN 80	120	230	253	1 –
637412	DN 100	120	230	450	1 –
637214	DN 65	120	24	170	1 –
637314	DN 80	120	24	253	1 –
637414	DN 100	120	24	450	1 –

Spare actuators for motorised three-way piston valves 636 series.



Code	Supply voltage V		
R69084	230	1	–
R69085	24	1	–



Spare actuators for motorised two-way ball valves 637 series.

Code	Supply voltage V		
637022	230	1	–
637024	24	1	–

MOTORISED BUTTERFLY VALVE

639



Motorised butterfly valve, WAFER type.
 With manual opening.
 Flanged connections PN 16.
 To be coupled with flat counterflanges EN 1092-1.
With auxiliary microswitch.
 Supply: 230 V (ac) or 24 V (ac).
 Max. working pressure: 16 bar.
 Max. Δp: 6 bar.
 Valve temperature range: 5–95°C.
 Ambient temperature range: 5–65°C.
 Power consumption: 4,5 VA.
 Auxiliary microswitch contact rating: 16 (4) A - 250 V (ac).
 Protection class: IP 42.
 Operating time: 180 s (90° rotation).







639



Motorised butterfly valve, WAFER type.
 With manual opening.
 Flanged connections PN 16.
 To be coupled with flat counterflanges EN 1092-1.
With auxiliary microswitch.
 Supply: 230 V (ac) or 24 V (ac).
 Max. working pressure: 16 bar.
 Max. Δp: 6 bar.
 Valve temperature range: 5–95°C.
 Ambient temperature range: 5–65°C.
 Power consumption: 10,5 VA.
 Auxiliary microswitch contact rating: 16 (6) A - 250 V (ac) - double switch.
 Protection class: IP 65.
 Operating time: 180 s (90° rotation).



Code		Supply voltage V		
639042	DN 32/40	230	1	–
639052	DN 50	230	1	–
639062	DN 65	230	1	–
639082	DN 80	230	1	–
639044	DN 32/40	24	1	–
639054	DN 50	24	1	–
639064	DN 65	24	1	–
639084	DN 80	24	1	–



Code		Supply voltage V		
639102	DN 100	230	1	–
639122	DN 125	230	1	–
639152	DN 150	230	1	–
639202	DN 200	230	1	–
639104	DN 100	24	1	–
639124	DN 125	24	1	–
639154	DN 150	24	1	–
639204	DN 200	24	1	–

SINGLE DISTRIBUTION MANIFOLDS

349

Modular single distribution manifold.
For heating and air conditioning systems.
Max. working pressure: 10 bar.
Temperature range: -10–110°C.
Outlet centre distance: 35 mm.





Code	Connections	Outlet No.	Outlets		
349020	3/4"	x 2	23 p.1,5 M	5	50
349030	3/4"	x 3	23 p.1,5 M	5	50
349040	3/4"	x 4	23 p.1,5 M	5	50
349050	3/4"	x 5	23 p.1,5 M	5	50

354

Modular single distribution manifold with shut-off valves.
CR dezincification resistant alloy body.
Max. working pressure: 10 bar.
Temperature range: 5–100°C.
Outlet centre distance: 35 mm.





Code	Connections	Outlet No.	Outlets		
354052	3/4"	x 2	23 p.1,5 M	5	20
354053	3/4"	x 3	23 p.1,5 M	5	20
354054	3/4"	x 4	23 p.1,5 M	5	20
354055	3/4"	x 5	23 p.1,5 M	5	20

350

Modular single distribution manifold.
For heating and air conditioning systems.
Max. working pressure: 10 bar.
Temperature range: -10–110°C.
Outlet centre distance: 50 mm for 3/4" and 1".
Outlet centre distance: 60 mm for 1 1/4".
PTFE seal on coupling.





Code	Connections	Outlet No.	Outlets		
350520	3/4"	x 2	23 p.1,5 M	2	–
350530	3/4"	x 3	23 p.1,5 M	2	–
350540	3/4"	x 4	23 p.1,5 M	2	–
350620	1"	x 2	23 p.1,5 M	2	–
350630	1"	x 3	23 p.1,5 M	2	–
350640	1"	x 4	23 p.1,5 M	2	–
350720*	1 1/4"	x 2	23 p.1,5 M	2	–
350730*	1 1/4"	x 3	23 p.1,5 M	2	–
350740*	1 1/4"	x 4	23 p.1,5 M	2	–

* Without PTFE seal on coupling

351

Blind single distribution manifold.
For heating and air conditioning systems.
Max. working pressure: 10 bar.
Temperature range: -10–110°C.
Outlet centre distance: 50 mm.



Code	Connections	Outlet No.	Outlets		
351520	3/4"	x 2	23 p.1,5 M	2	–
351530	3/4"	x 3	23 p.1,5 M	2	–
351540	3/4"	x 4	23 p.1,5 M	2	–
351620	1"	x 2	23 p.1,5 M	2	–
351630	1"	x 3	23 p.1,5 M	2	–
351640	1"	x 4	23 p.1,5 M	2	–

DUAL DISTRIBUTION MANIFOLDS AND FITTINGS

356

tech. broch. 01014

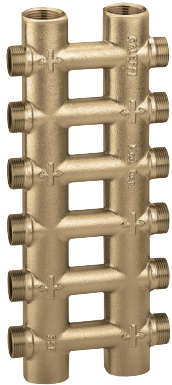

Cast monoblock dual distribution manifold. For heating and air conditioning systems. Max. working pressure: 10 bar. Temperature range: -10–110°C. Main centre distance: 60 mm. Outlet centre distance: 40 mm.

Code	Connections	Outlet No.	Outlets		
356502	3/4"	2+2	23 p.1,5 M	1	5
356504	3/4"	4+4	23 p.1,5 M	1	5
356506	3/4"	6+6	23 p.1,5 M	1	5
356508	3/4"	8+8	23 p.1,5 M	1	5
356510	3/4"	10+10	23 p.1,5 M	1	5
356604	1"	4+4	23 p.1,5 M	1	5
356606	1"	6+6	23 p.1,5 M	1	5
356608	1"	8+8	23 p.1,5 M	1	5
356610	1"	10+10	23 p.1,5 M	1	5
356612	1"	12+12	23 p.1,5 M	1	-

356

tech. broch. 01014



Cast monoblock dual distribution manifold. For heating and air conditioning systems. **With insulation.** Max. working pressure: 10 bar. Temperature range: 0–100°C. Main centre distance: 60 mm. Outlet centre distance: 40 mm.

Code	Connections	Outlet No.	Outlets		
356604 IS	1"	4+4	23 p.1,5 M	1	10
356606 IS	1"	6+6	23 p.1,5 M	1	10
356608 IS	1"	8+8	23 p.1,5 M	1	5
356610 IS	1"	10+10	23 p.1,5 M	1	5

357

tech. broch. 01014



Single sided cast monoblock dual distribution manifold. For heating and air conditioning systems. Max. working pressure: 10 bar. Temperature range: -10–110°C. Main centre distance: 60 mm. Outlet centre distance: 40 mm.

Code	Connections	Outlet No.	Outlets		
357502	3/4"	2+2	23 p.1,5 M	1	10
357503	3/4"	3+3	23 p.1,5 M	1	10
357504	3/4"	4+4	23 p.1,5 M	1	5
357505	3/4"	5+5	23 p.1,5 M	1	-
357506	3/4"	6+6	23 p.1,5 M	1	-

356

tech. broch. 01014



Differential by-pass for dual distribution manifolds 356 and 357 series. 3/8" connection for automatic air vent. Fixed differential by-pass setting: 20 kPa (2000 mm w.g.). Max. working pressure: 10 bar. Temperature range: -10–110°C.

Code	Connections	Outlet No.	Outlets		
356050	3/4" M			1	20

3640

End fitting. For distribution manifolds 356 and 357 series.



Code	Connections	Outlet No.	Outlets		
364050	3/4" M x 23 p.1,5 M			2	-
364060	1" M x 23 p.1,5 M			2	-

3641

Plug. For distribution manifolds 356 and 357 series.



Code	Connections	Outlet No.	Outlets		
364150	3/4" M			2	-
364160	1" M			2	-

3642

End fitting for air vent connection. For distribution manifolds 356 and 357 series.



Code	Connections	Outlet No.	Outlets		
364253	3/4" M x 3/8" F			2	-
364254	3/4" M x 1/2" F			2	-
364263	1" M x 3/8" F			2	-

SINGLE DISTRIBUTION MANIFOLDS



349

Modular single distribution manifold.
Max. working pressure: 10 bar.
Temperature range: -10–110°C.
Outlet centre distance: 35 mm.
Outlet male connections.

Code	Connections	Outlet No.	Outlets		
349130	3/4"	x 3	1/2" M	5	50
349140	3/4"	x 4	1/2" M	5	50
349150	3/4"	x 5	1/2" M	5	50



349

Modular single distribution manifold.
Max. working pressure: 10 bar.
Temperature range: -10–110°C.
Outlet centre distance: 35 mm.
Outlet male connections.
With flat seat.
For press-fittings.

Code	Connections	Outlet No.	Outlets		
349230	3/4"	x 3	1/2" M - Ø 13	5	50
349240	3/4"	x 4	1/2" M - Ø 13	5	50
349250	3/4"	x 5	1/2" M - Ø 13	5	50



349

Modular single distribution manifold.
Max. working pressure: 10 bar.
Temperature range: -10–110°C.
Outlet centre distance: 35 mm.
Outlet female connections.

Code	Connections	Outlet No.	Outlets		
349330	3/4"	x 3	1/2" F	5	50
349340	3/4"	x 4	1/2" F	5	50
349350	3/4"	x 5	1/2" F	5	50



354

Modular single distribution manifold with shut-off valves.
CR dezincification resistant alloy body.
Max. working pressure: 10 bar.
Temperature range: 5–100°C.
Outlet centre distance: 35 mm.
Outlet male connections.
With flat seat.
For press-fittings.

Code	Connections	Outlet No.	Outlets		
354252	3/4"	x 2	1/2" M - Ø 13	2	30
354253	3/4"	x 3	1/2" M - Ø 13	2	20
354254	3/4"	x 4	1/2" M - Ø 13	2	10
354255	3/4"	x 5	1/2" M - Ø 13	2	10



592

Modular single distribution manifold.
Max. working pressure: 10 bar.
Temperature range: -10–110°C.
PTFE seal on coupling.
Outlet male connections.

Code	Connections	Outlet No.	Outlets	Outlet centre distance		
592525	3/4"	x 2	1/2" M	50	2	–
592535	3/4"	x 3	1/2" M	50	2	–
592545	3/4"	x 4	1/2" M	50	2	–
592625	1"	x 2	1/2" M	50	2	–
592635	1"	x 3	1/2" M	50	2	–
592645	1"	x 4	1/2" M	50	2	–
592626	1"	x 2	1/2" M	60	2	–
592636	1"	x 3	1/2" M	60	2	–
592646	1"	x 4	1/2" M	60	2	–
592726*	1 1/4"	x 2	1/2" M	60	2	–
592736*	1 1/4"	x 3	1/2" M	60	2	–
592746*	1 1/4"	x 4	1/2" M	60	2	–
592622	1"	x 2	3/4" M	60	2	–
592632	1"	x 3	3/4" M	60	2	–

* Without PTFE on coupling



592

Modular single distribution manifold.
Max. working pressure: 10 bar.
Temperature range: -10–110°C.
PTFE seal on coupling.
Outlet female connections.

Code	Connections	Outlet No.	Outlets	Outlet centre distance		
592527	3/4"	x 2	1/2" F	50	2	–
592537	3/4"	x 3	1/2" F	50	2	–
592547	3/4"	x 4	1/2" F	50	2	–
592627	1"	x 2	1/2" F	50	2	–
592637	1"	x 3	1/2" F	50	2	–
592647	1"	x 4	1/2" F	50	2	–
592628	1"	x 2	1/2" F	60	2	–
592638	1"	x 3	1/2" F	60	2	–
592648	1"	x 4	1/2" F	60	2	–
592728*	1 1/4"	x 2	1/2" F	60	2	–
592738*	1 1/4"	x 3	1/2" F	60	2	–
592748*	1 1/4"	x 4	1/2" F	60	2	–

* Without PTFE on coupling

SINGLE DISTRIBUTION MANIFOLDS



598

Blind single distribution manifold. For heating and air conditioning systems. Max. working pressure: 10 bar. Temperature range: -10–110°C. Outlet centre distance: 50 mm. **Outlet male connections.**

Code	Connections	Outlet No.	Outlets		
598521	3/4"	x 2	1/2" M	2	–
598531	3/4"	x 3	1/2" M	2	–
598541	3/4"	x 4	1/2" M	2	–
598621	1"	x 2	1/2" M	2	–
598631	1"	x 3	1/2" M	2	–
598641	1"	x 4	1/2" M	2	–



598

Blind single distribution manifold. For heating and air conditioning systems. Max. working pressure: 10 bar. Temperature range: -10–110°C. Outlet centre distance: 50 mm. **Outlet female connections.**

Code	Connections	Outlet No.	Outlets		
598522	3/4"	x 2	1/2" F	2	–
598532	3/4"	x 3	1/2" F	2	–
598542	3/4"	x 4	1/2" F	2	–
598622	1"	x 2	1/2" F	2	–
598632	1"	x 3	1/2" F	2	–
598642	1"	x 4	1/2" F	2	–

SINGLE DISTRIBUTION MANIFOLDS FOR AIR CONDITIONING SYSTEMS

650

tech. broch. 01067

Modular single distribution manifold. For air conditioning systems.

With insulation.

Max. working pressure: 10 bar. Temperature range: -40–95°C. Outlet centre distance: 60 mm.

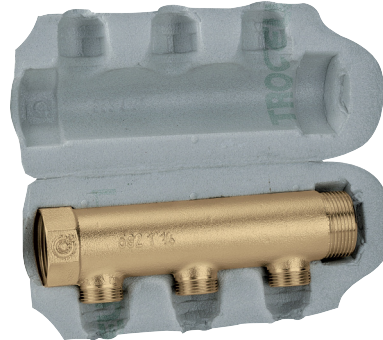

Code	Connections	Outlet No.	Outlets		
650722	1 1/4"	x 2	3/4" M	2	–
650732	1 1/4"	x 3	3/4" M	2	–
650742	1 1/4"	x 4	3/4" M	2	–

615

Super-bright glue, to seal the insulation of manifolds 650 series, deaerators 551 DISCAL® series and separator-manifold 559 SEPCOLL series. Content: 125 g.



Code		
615500	1	–

DISTRIBUTION MANIFOLDS WITH SHUT-OFF AND PRE-REGULATING VALVES

662

Distribution manifold group.
 Max. working pressure: 10 bar.
 Temperature range: 5–100°C.
 Outlet centre distance: 50 mm.

tech. broch. 01180

Insulation for distribution manifolds
 662, 664 and 665 series.
 For heating and cooling systems.
For use with box code 659..4
 (adjustable depth from 110 to 140 mm).

Consisting of:

- return manifold complete with shut-off valves fitted for thermo-electric actuator;
- flow manifold complete with lockshield valves for flow rate pre-regulation;
- end fittings consisting of double radial end fitting, manual air vent and plugs.
- steel mounting brackets for use with box 659 series or for direct wall fixing.

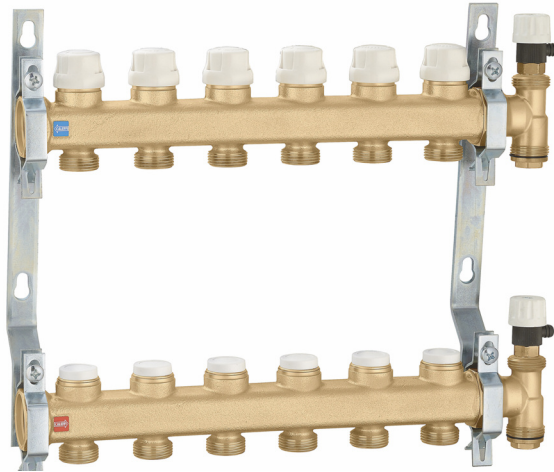

Code

Code	Description	Green Box	Yellow Box
CBN6646F1	for manifolds from 2 to 6 outlets	1	-
CBN6646N1	for manifolds from 7 to 12 outlets	1	-
CBN6646O1	for manifolds with 13 outlets	1	-

Code	Connections	Outlet No.	Outlets	Green Box	Yellow Box
6626B5	1"	x 2	3/4" M	1	-
6626C5	1"	x 3	3/4" M	1	-
6626D5	1"	x 4	3/4" M	1	-
6626E5	1"	x 5	3/4" M	1	-
6626F5	1"	x 6	3/4" M	1	-
6626G5	1"	x 7	3/4" M	1	-
6626H5	1"	x 8	3/4" M	1	-
6626I 5	1"	x 9	3/4" M	1	-
6626L 5	1"	x 10	3/4" M	1	-
6626M5	1"	x 11	3/4" M	1	-
6626N5	1"	x 12	3/4" M	1	-
6626O5	1"	x 13	3/4" M	1	-

DISTRIBUTION MANIFOLDS WITH SHUT-OFF AND PRE-REGULATING VALVES

662

tech. broch. 01180

Pair of manifolds equipped with shut-off and lockshield valves for flow rate pre-regulation. Max. working pressure: 10 bar. Temperature range: 5–100°C. Outlet centre distance: 50 mm.



Code	Connections	Outlet No.	Outlets		
662625	1"	x 2	3/4" M	1	–
662635	1"	x 3	3/4" M	1	–
662645	1"	x 4	3/4" M	1	–
662655	1"	x 5	3/4" M	1	–
662665	1"	x 6	3/4" M	1	–

6620

tech. broch. 01180

Return manifold equipped with shut-off valves, fitted for thermo-electric actuator. Max. working pressure: 10 bar. Temperature range: 5–100°C. Outlet centre distance: 50 mm.



Code	Connections	Outlet No.	Outlets		
662025	1"	x 2	3/4" M	2	–
662035	1"	x 3	3/4" M	2	–
662045	1"	x 4	3/4" M	2	–
662055	1"	x 5	3/4" M	2	–
662065	1"	x 6	3/4" M	2	–

6621

tech. broch. 01180

Flow manifold equipped with lockshield valves for flow rate pre-regulation. Max. working pressure: 10 bar. Temperature range: 5–100°C. Outlet centre distance: 50 mm.



Code	Connections	Outlet No.	Outlets		
662125	1"	x 2	3/4" M	2	–
662135	1"	x 3	3/4" M	2	–
662145	1"	x 4	3/4" M	2	–
662155	1"	x 5	3/4" M	2	–
662165	1"	x 6	3/4" M	2	–



5996

tech. broch. 01180

End fitting consisting of double radial end fitting, air vent cock and plug. Max. working pressure: 10 bar. Temperature range: 5–100°C.

Code			
599662	1" F	1	25



662

tech. broch. 01180

Fixed setting differential by-pass kit 20 kPa (2000 mm w.g.), with flexible hose. For distribution manifolds 662 series. Max. working pressure: 10 bar. Temperature range: 0–100°C.

Code			
662000	3/4" F nut x 3/4" F	1	5

Connection example of differential by-pass code 662000 with manifold 662 series

This special by-pass kit consists of a flexible hose which makes installation easier and allows the manifold to be adapted to suit the brackets, according to the actual positions of the system flow and return piping.

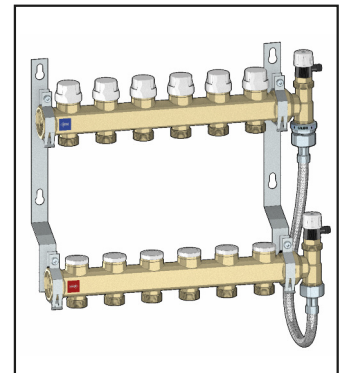

NEW



658

Pair of steel mounting brackets for distribution manifolds 662 and 664 series. To be used with boxes code 659..5 or directly wall mounted.

Code			
658101		1	–

658

tech. broch. 01180

Polymer mounting brackets with adjustable centre distance, for distribution manifolds 662 series. With screws and wall anchors. To be used with boxes code 659..4 (depth 110–140 mm) or directly wall mounted.



Code			
658400		1	5

DISTRIBUTION MANIFOLDS WITH SHUT-OFF AND PRE-REGULATING VALVES

663

tech. broch. 01065

Pre-assembled distribution manifold.
 Max. working pressure: 10 bar.
 Temperature range: 5–100°C.
 Outlet centre distance: 50 mm.

Consisting of:

- 1 return distribution manifold complete with shut-off valves fitted for thermo-electric actuator;
- 1 flow distribution manifold complete with lockshield valves for flow rate pre-regulation;
- 2 mounting brackets code 658100;
- 2 reduction fittings 1 1/4" M x 1" F code 364276;
- 2 double radial end fittings code 599473 with plugs.

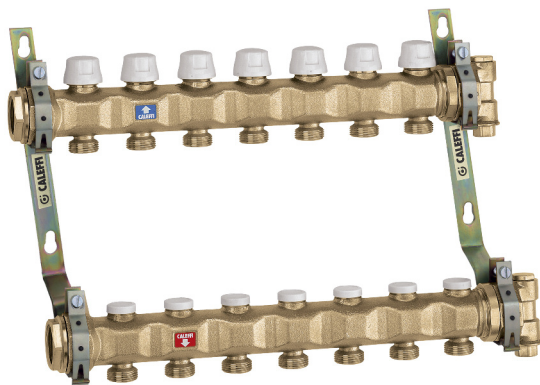

663

tech. broch. 01065

Pre-assembled distribution manifold for air conditioning systems.



With insulation.

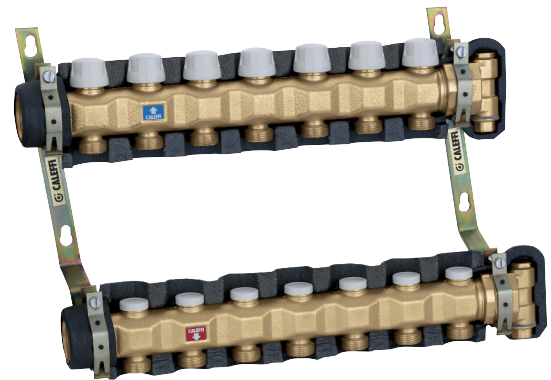

Max. working pressure: 10 bar.
 Temperature range: 5–100°C.
 Outlet centre distance: 50 mm.

Consisting of:

- 1 return distribution manifold complete with shut-off valves fitted for thermo-electric actuator;
- 1 flow distribution manifold complete with lockshield valve for flow rate pre-regulation;
- 2 mounting brackets code 658100;
- 2 reduction fittings 1 1/4" M x 1" F code 364276;
- 2 double radial end fittings code 599473 with plugs.



Code	Connections	Outlet No.	Outlets		
6637C5	1 1/4" x 3	3	3/4" M	1	–
6637D5	1 1/4" x 4	4	3/4" M	1	–
6637E5	1 1/4" x 5	5	3/4" M	1	–
6637F5	1 1/4" x 6	6	3/4" M	1	–
6637G5	1 1/4" x 7	7	3/4" M	1	–
6637H5	1 1/4" x 8	8	3/4" M	1	–
6637I5	1 1/4" x 9	9	3/4" M	1	–
6637L5	1 1/4" x 10	10	3/4" M	1	–
6637M5	1 1/4" x 11	11	3/4" M	1	–
6637N5	1 1/4" x 12	12	3/4" M	1	–
6637O5	1 1/4" x 13	13	3/4" M	1	–

Code	Connections	Outlet No.	Outlets		
6637C5 IS	1 1/4" x 3	3	3/4" M	1	–
6637D5 IS	1 1/4" x 4	4	3/4" M	1	–
6637E5 IS	1 1/4" x 5	5	3/4" M	1	–
6637F5 IS	1 1/4" x 6	6	3/4" M	1	–
6637G5 IS	1 1/4" x 7	7	3/4" M	1	–
6637H5 IS	1 1/4" x 8	8	3/4" M	1	–
6637I5 IS	1 1/4" x 9	9	3/4" M	1	–
6637L5 IS	1 1/4" x 10	10	3/4" M	1	–
6637M5 IS	1 1/4" x 11	11	3/4" M	1	–
6637N5 IS	1 1/4" x 12	12	3/4" M	1	–
6637O5 IS	1 1/4" x 13	13	3/4" M	1	–

DISTRIBUTION MANIFOLDS WITH SHUT-OFF AND PRE-REGULATING VALVES

663

tech. broch. 01065

Pair of distribution manifolds equipped with shut-off and lockshield valves for flow rate pre-regulation. Max. working pressure: 10 bar. Temperature range: 5–100°C. Outlet centre distance: 50 mm.



Code	Connections	Outlet No.	Outlets		
663735	1 1/4"	x 3	3/4" M	1	–
663745	1 1/4"	x 4	3/4" M	1	–
663755	1 1/4"	x 5	3/4" M	1	–
663765	1 1/4"	x 6	3/4" M	1	–
663775	1 1/4"	x 7	3/4" M	1	–
663785	1 1/4"	x 8	3/4" M	1	–

6630

tech. broch. 01065

Return distribution manifold equipped with shut-off valves, fitted for thermo-electric actuator. Max. working pressure: 10 bar. Temperature range: 5–100°C. Outlet centre distance: 50 mm.



Code	Connections	Outlet No.	Outlets		
663030	1 1/4"	x 3	3/4" M	2	–
663040	1 1/4"	x 4	3/4" M	2	–
663050	1 1/4"	x 5	3/4" M	2	–
663060	1 1/4"	x 6	3/4" M	2	–
663070	1 1/4"	x 7	3/4" M	2	–
663080	1 1/4"	x 8	3/4" M	2	–

6631

tech. broch. 01065

Flow distribution manifold equipped with lockshield valve for flow rate pre-regulation. Max. working pressure: 10 bar. Temperature range: 5–100°C. Outlet centre distance: 50 mm.



Code	Connections	Outlet No.	Outlets		
663130	1 1/4"	x 3	3/4" M	2	–
663140	1 1/4"	x 4	3/4" M	2	–
663150	1 1/4"	x 5	3/4" M	2	–
663160	1 1/4"	x 6	3/4" M	2	–
663170	1 1/4"	x 7	3/4" M	2	–
663180	1 1/4"	x 8	3/4" M	2	–

663

Off-centre by-pass kit with fixed setting 20 kPa (2000 mm w.g.). For pre-assembled distribution manifolds 663 series. Max. working pressure: 10 bar. Temperature range: -10–110°C.



Code	Connections		
663000	1/2" M x 3/8" M	1	20

Connection example of differential by-pass code 663000 with pre-assembled distribution manifold 663 series

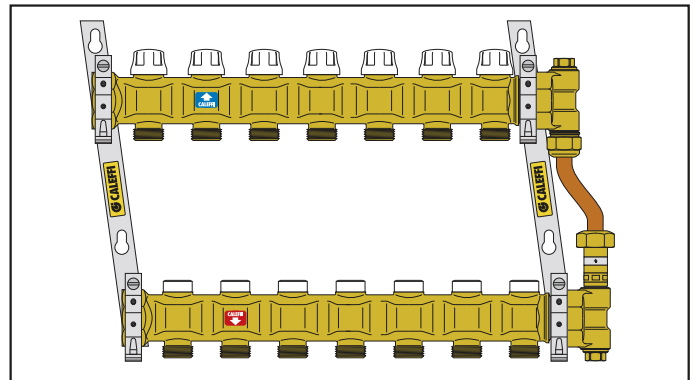

391

Pair of ball valves. Female - male connections with union. With temperature gauge, scale: 0–80°C, Ø 40 mm. Max. working pressure: 10 bar. Temperature range: 0–100°C.



Code	Connections		
391167	1" x 1 1/4"	1	–
391177	1 1/4" x 1 1/4"	1	–

391

Pair of ball valves. Female - male connections with union. With temperature gauge connection. Max. working pressure: 10 bar. Temperature range: 0–100°C.

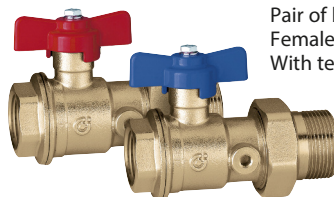

Code	Connections		
391067	1" x 1 1/4"	1	–
391077	1 1/4" x 1 1/4"	1	–

THERMO-ELECTRIC ACTUATORS

6563

tech. broch. 01142



Thermo-electric actuator.
With manual opening and position indicator.
For distribution manifolds 662 and 663 series.
Normally closed.
With auxiliary microswitch.
Supply: 230 V (ac) or 24 V (ac)/(dc).
Power consumption: 3 W.
Starting current: ≤ 1 A.
Starting current (656344/54): ≤ 250 mA.
Auxiliary microswitch contact rating:
0,8 A (230 V).
Ambient temperature range: 0–50°C.
Protection class: IP 40.
Cable length: 80 cm.

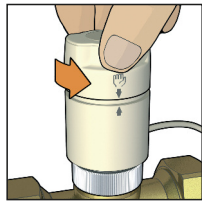

Code	Supply voltage V			
656312	230		1	10
656314	24		1	10
656302	230	without auxiliary microswitch	1	10
656304	24	without auxiliary microswitch	1	10

With low power consumption

Code	Supply voltage V			
656354	24		1	10
656344	24	without auxiliary microswitch	1	10

6561

tech. broch. 01042



Thermo-electric actuator.
For distribution manifolds 662 and 663 series.
Normally closed.
With auxiliary microswitch.
Supply: 230 V (ac) or 24 V (ac)/(dc).
Auxiliary microswitch contact rating:
0,8 A (230 V).
Power consumption: 3 W.
Starting current: ≤ 1 A.
Ambient temperature range: 0–50°C.
Protection class: IP 44 (vertical stem).
Cable length: 80 cm.



Code	Supply voltage V			
656112	230		1	10
656114	24		1	10
656102	230	without auxiliary microswitch	1	10
656104	24	without auxiliary microswitch	1	10

6562

tech. broch. 01198



Thermo-electric actuator.
With opening position indicator.
**Quick-coupling installation,
with a clip adapter.**
For distribution manifolds 662 and 663 series.
Normally closed.
With auxiliary microswitch.
Supply: 230 V (ac) or 24 V (ac)/(dc).
Auxiliary microswitch contact rating:
0,8 A (230 V).
Power consumption: 3 W.
Starting current: ≤ 1 A.
Ambient temperature range: 0–50°C.
Protection class: IP 54.
Cable length: 80 cm.

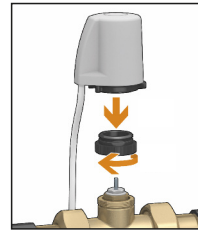

Code	Supply voltage V			
656212	230		1	10
656214	24		1	10
656202	230	without auxiliary microswitch	1	10
656204	24	without auxiliary microswitch	1	10

6564

tech. broch. 01198



Thermo-electric actuator
with low power consumption.
With opening position indicator.
**Quick-coupling installation,
with a clip adapter.**
For distribution manifolds 662 and 663 series.
Normally closed.
With auxiliary microswitch.
Supply: 230 V (ac) or 24 V (ac)/(dc).
Auxiliary microswitch contact rating:
0,8 A (230 V).
Power consumption: 3 W.
Starting current: ≤ 250 mA.
Ambient temperature range: 0–50°C.
Protection class: IP 54.
Cable length: 80 cm.



Code	Supply voltage V			
656412	230		1	10
656414	24		1	10
656402	230	without auxiliary microswitch	1	10
656404	24	without auxiliary microswitch	1	10



385

Shut-off ball cook, for distribution manifold outlets. Max. working pressure: 10 bar. Max. working temperature: 100°C. With handle.

Code			
385000	23 p.1,5 M x F nut	10	-



385

Shut-off ball cook, for distribution manifold outlets. Max. working pressure: 10 bar. Max. working temperature: 100°C. Without handle.

Code			
385010	23 p.1,5 M x F nut	15	150

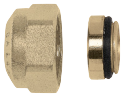

386

Screw plug with nut for distribution manifold outlets.

Code			
386000	23 p.1,5	10	-



383

Female fitting to nut and olive coupling.

Code			
383030	3/8" F x 23 p.1,5 M	10	-
383040	1/2" F x 23 p.1,5 M	10	-
383050	3/4" F x 23 p.1,5 M	10	-
383140	23 p.1,5 F x 1/2" M	10	-
383150	23 p.1,5 F x 3/4" M	10	-
383151	23 p.1,5 F x 3/4" M chrome plated	10	-



383

Connection fitting with O-Ring seal for use with 3/4" 347, 679 and 680 series.

Code			
383550	3/4" M x 23 p.1,5	10	100



383

Female-female fitting.

Code			
383240	23 p.1,5 F x 1/2" F	10	-



384

Male fitting to nut and olive coupling.

Code			
384030	3/8" M x 23 p.1,5 M	10	-
384040	1/2" M x 23 p.1,5 M	10	-
384050	3/4" M x 23 p.1,5 M	10	-



384

Male fitting to nut and olive coupling. Chrome plated.

Code			
384031	3/8" M x 23 p.1,5 M	10	-
384041	1/2" M x 23 p.1,5 M	10	-



382

Fitting with 23 p.1,5 captive nut. Chrome plated. Max. working pressure: 10 bar. Max. working temperature: 100°C.

Code			
382000	23 p.1,5 M x nut 23 p.1,5 F	10	-

NEW



383

Adapter with flat seat with O-Ring. Transformation from 3/4" Euroconus to 3/4" flat seat.

Code			
383000	3/4"	1	-



392

Temperature gauge fitting.
For distribution manifolds 592 and 350 series.
Temperature gauge 0–80°C, Ø 40 mm.

Code			
392600	1" F x M with PTFE seal	1	-
392700	1 1/4" F x M without PTFE seal	1	-



657

Temperature gauge fitting.
Temperature gauge 0–80°C, Ø 40 mm.

Code			
657400	1/2" M x 1/2" F	5	-



657

Temperature gauge fitting.
For distribution manifold outlets.
Temperature gauge 0–80°C, Ø 40 mm.

Code			
657050	3/4" M x 3/4" F nut	1	12



669

Self cleaning flow meter.
Flow rate scale: 1–4 l/min.
Double reading scale.
Max. working pressure: 6 bar.
Max. working temperature: 80°C.
Accuracy: ±10%.

Code			
669050	3/4" M x 3/4" F nut	1	10



688

Temperature gauge with pocket.
Scale 0–80°C.
Ø 40 mm.

tech. broch. 01144

Code			
688002	1/4"	2	-



3642

Reduction fitting.

Code			
364276	1" F x 1 1/4" M	2	-



5991

End fitting.
For distribution manifolds 349, 350, 592, 650 and 663 series.

Code			
599153	3/4" F x 3/8" F	2	-
599154	3/4" F x 1/2" F	2	-
599163	1" F x 3/8" F	2	-
599164	1" F x 1/2" F	2	-
599173	1 1/4" F x 3/8" F	2	-
599174	1 1/4" F x 1/2" F	2	-



5993

Plug.
For distribution manifolds 349, 350, 592, 650 and 663 series.

Code			
599350	3/4" F	2	10
599360	1" F	2	10
599370	1 1/4" F	2	10



5994

Double radial end fitting.
For distribution manifolds 349, 350, 592, 650 and 663 series.

Code			
599453	3/4" F x 1/2" F x 3/8" F	2	-
599454	3/4" F x 1/2" F x 1/2" F	2	-
599463	1" F x 1/2" F x 3/8" F	2	-
599464	1" F x 1/2" F x 1/2" F	2	-
599473	1 1/4" F x 1/2" F x 3/8" F	2	-
599474	1 1/4" F x 1/2" F x 1/2" F	2	-



5995

Single radial end fitting.
For distribution manifolds 349, 350, 592, 650 and 663 series.

Code			
599553	3/4" F x 3/8" F	2	-
599563	1" F x 3/8" F	2	-
599573	1 1/4" F x 3/8" F	2	-



586

Female blind end plug.

Code			
586300	3/8" F	10	-
586400	1/2" F	10	-
586600	1" F	10	-



585

Stiffener for copper pipe with wall thickness 0,75 and 1 mm.

Code		Thickness (mm)		
585010	Ø 10	0,75	100	-
585012	Ø 12	0,75	100	-
585014	Ø 14	0,75	100	-
585015	Ø 15	0,75	100	-
585016	Ø 16	0,75	100	-
585018	Ø 18	0,75	100	-
585110	Ø 10	1	100	-
585112	Ø 12	1	100	-
585114	Ø 14	1	100	-
585115	Ø 15	1	100	-
585116	Ø 16	1	100	-
585118	Ø 18	1	100	-

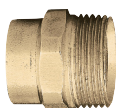

583

Female compression fitting for outlets.

Code			
583034	3/8" F x 1/2" M - Ø 16	10	-
583045	1/2" F x 3/4" M - Ø 18	10	-
583064	1" F x 1/2" M - Ø 16	10	-
583065	1" F x 3/4" M - Ø 18	10	-



584

Male compression fitting for outlets.

Code			
584053	3/4" M x 3/8" M - Ø 12	10	-
584054	3/4" M x 1/2" M - Ø 16	10	-
584055	3/4" M x 3/4" M - Ø 18	10	-
584065	1" M x 3/4" M - Ø 18	10	-

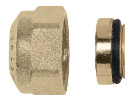

386

Screw plug with nut for distribution manifold outlets.

Code			
386500	3/4"	10	-

FITTINGS



679
DARCAL

Fitting for multilayer plastic pipe for continuous high temperature use.
Max. working pressure: 10 bar.
Temperature range: 0–95°C.

For a correct use, adjust the multilayer pipe diameter before installation using the Caleffi calibrator 679 series (see page 68).

Code			
679114	23 p.1,5 - Ø 14x2	10	100
679124	23 p.1,5 - Ø 16x2	10	100
679125	23 p.1,5 - Ø 16x2,25	10	100
679144	23 p.1,5 - Ø 18x2	10	100



446

Pre-assembled compression ends fitting, for annealed copper, hard copper, brass, mild steel and stainless steel pipes.
With O-Ring seal.
Max. working pressure: 10 bar.
Temperature range: -25–120°C.

Code			
446010	23 p.1,5 - Ø 10	100	–
446012	23 p.1,5 - Ø 12	100	–
446014	23 p.1,5 - Ø 14	100	–
446015	23 p.1,5 - Ø 15	100	–
446016	23 p.1,5 - Ø 16	100	–



680
DARCAL

Self-adjustable diameter fitting for single and multilayer plastic pipes.
Max. working pressure: 10 bar.
Temperature range:
5–80°C (PE-X)
5–75°C (Multilayer marked 95°C).

Code		Ø _{inside}	Ø _{outside}		
680000	23 p.1,5	7,5– 8	12–14	10	100
680002	23 p.1,5	9 – 9,5	14–16	10	100
680001	23 p.1,5	9,5–10	12–14	10	100
680006	23 p.1,5	9,5–10	14–16	10	100
680015	23 p.1,5	10,5–11	14–16	10	100
680017	23 p.1,5	10,5–11	16–18	10	100
680024	23 p.1,5	11,5–12	14–16	10	100
680026	23 p.1,5	11,5–12	16–18	10	100
680035	23 p.1,5	12,5–13	16–18	10	100
680044	23 p.1,5	13,5–14	16–18	10	100



347

Compression ends fitting, for annealed copper, hard copper, brass, mild steel and stainless steel pipes.
With O-Ring seal.
Max. working pressure: 10 bar.
Temperature range: -25–120°C.

Code			
347010	23 p.1,5 - Ø 10	100	–
347012	23 p.1,5 - Ø 12	100	–
347014	23 p.1,5 - Ø 14	100	–
347015	23 p.1,5 - Ø 15	100	–
347016	23 p.1,5 - Ø 16	100	–



680
DARCAL

Self-adjustable diameter fitting for single and multilayer plastic pipes.
Max. working pressure: 10 bar.
Temperature range:
5–80°C (PE-X)
5–75°C (Multilayer marked 95°C).

Code		Ø _{inside}	Ø _{outside}		
680055	23 p.1,5	14,5–15	18–20	10	100
680064	23 p.1,5	15,5–16	18–20	10	100

Example: 680 series fitting selection

Known both the outside and inside diameters (ex.: 17 mm and 13 mm);
or known the outside diameter (ex.: Ø 17 mm) and the thickness (ex.: th. 2 mm) and considering that:

$$\text{Ø}_{\text{outside}} - 2 \cdot \text{th.} = \text{Ø}_{\text{inside}}$$

$$17 - 2 \cdot 2 = 13 \text{ mm}$$

Look within the table for the code matching both diameters:

Code		Ø _{inside}	Ø _{outside}
680035	23 p.1,5	12,5–13	16–18

FITTINGS



679
DARGAL

Fitting for multilayer pipes with continuous high temperature use.
Max. working pressure: 10 bar.
Temperature range: 0–95°C.

For a correct use, adjust the multilayer pipe diameter before installation using the Caleffi calibrator 679 series (see page 68).

Code				
679514	3/4"	Ø 14x2	10	100
679524	3/4"	Ø 16x2	10	100
679525	3/4"	Ø 16x2,25	10	100
679544	3/4"	Ø 18x2	10	100
679564	3/4"	Ø 20x2	10	100
679565	3/4"	Ø 20x2,25	10	100
679566	3/4"	Ø 20x2,5	10	100



680
DARGAL

Self-adjustable diameter fitting for single and multilayer plastic pipes.
Max. working pressure: 10 bar.
Temperature range:
5–80°C (PE-X)
5–75°C (Multilayer marked 95°C).

Code		Ø _{inside}	Ø _{outside}		
680507	3/4"	7,5– 8	10,5–12	10	100
680502	3/4"	7,5– 8	12 –14	10	100
680503	3/4"	8,5– 9	12 –14	10	100
680500	3/4"	9 – 9,5	14 –16	10	100
680501	3/4"	9,5–10	12 –14	10	100
680506	3/4"	9,5–10	14 –16	10	100
680515	3/4"	10,5–11	14 –16	10	100
680517	3/4"	10,5–11	16 –18	10	100
680524	3/4"	11,5–12	14 –16	10	100
680526	3/4"	11,5–12	16 –18	10	100
680535	3/4"	12,5–13	16 –18	10	100
680537	3/4"	12,5–13	18 –20	10	100
680544	3/4"	13,5–14	16 –18	10	100
680546	3/4"	13,5–14	18 –20	10	100
680555	3/4"	14,5–15	18 –20	10	100
680556	3/4"	15 –15,5	18 –20	10	100
680564	3/4"	15,5–16	18 –20	10	100
680505	3/4"	17	22,5	10	100



680
DARGAL

Self-adjustable diameter fitting for plastic pipes.
Max. working pressure: 10 bar.
Temperature range: 5–80°C.

Code		Ø _{inside}	Ø _{outside}		
680687	1"	17,5	25	10	100
680605	1"	19,5	25	10	100

NEW



680
DARGAL

Compression ends fitting for multilayer pipe with fitting M-F.

Code				
680285	3/4" F	Ø 25x2,5	10	–
680296	3/4" F	Ø 26x3	10	–



347

Compression ends fitting, for annealed copper, hard copper, brass, mild steel and stainless steel pipes. With O-Ring seal.
Max. working pressure: 10 bar.
Temperature range: -25–120°C.

Code				
347510	3/4"	Ø 10	100	–
347512	3/4"	Ø 12	100	–
347514	3/4"	Ø 14	100	–
347515	3/4"	Ø 15	100	–
347516	3/4"	Ø 16	100	–
347518	3/4"	Ø 18	10	–



591

Fitting for plastic pipes.

Code		Ø _{inside}	Ø _{outside}		
591401	1/2"	8	13	10	–
591402	1/2"	10	12	10	–
591405	1/2"	10	15	10	–
591414	1/2"	11,6	16	10	–
591424	1/2"	12	16	10	–
591433	1/2"	13	16	10	–
591565	3/4"	16	21	10	–
591566	3/4"	16	22	10	–



5812

Nut and olive or single groove seal in PTFE. For copper pipe.

Code				
581240	1/2"	+ single groove Ø 10	10	250
581242	1/2"	+ single groove Ø 12	10	250
581244	1/2"	+ single groove Ø 14	10	250
581245	1/2"	+ single groove Ø 15	10	250
581246	1/2"	+ olive Ø 16	10	250
581254	3/4"	+ single groove Ø 14	10	250
581256	3/4"	+ single groove Ø 16	10	250
581258	3/4"	+ olive Ø 18	10	250

RADIANT PANEL SYSTEM CONTROL

This diagram is just an indication

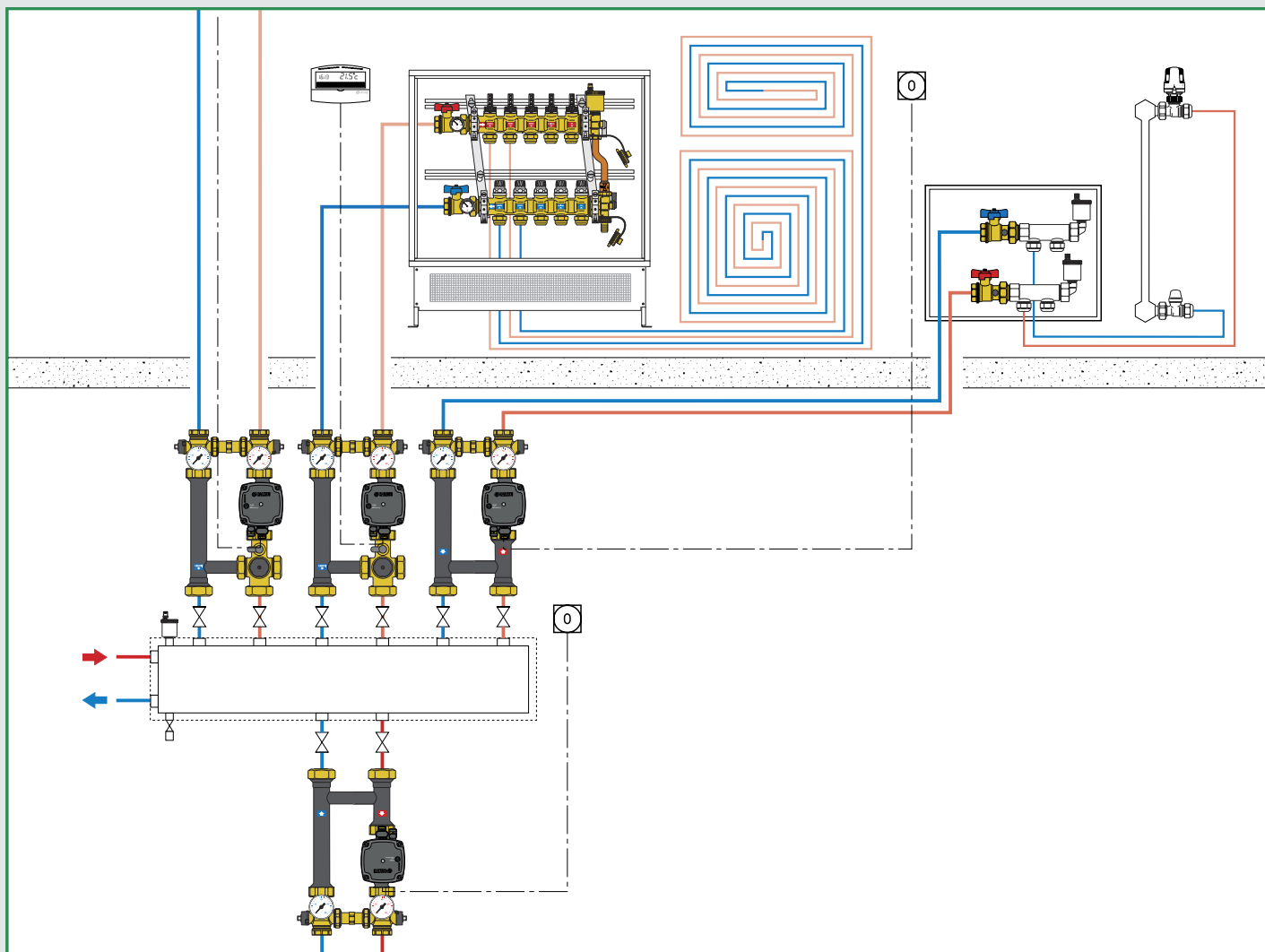

5

- Distribution units for SEPCOLL
- Temperature regulators
- Modulating temperature regulating units
- Set point thermostatic regulating units
- Thermostatic mixing valve for radiant panel systems

Distribution manifolds for radiant panel systems

DIRECT SUPPLY UNITS

165

tech. broch. 01237

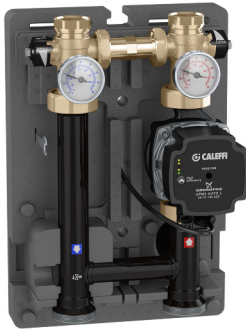

Direct supply unit for heating systems.
With pre-formed insulation.
 Max. working pressure: 10 bar.
 Max. working temperature: 100°C.
 Supply: 230 V - 50/60 Hz.
 System side connection: 1" F.
 Boiler side connection: 1 1/2" M.
Centre distance:
125 mm fitted for SEPCOLL.



THERMOSTATIC REGULATING UNIT

166

tech. broch. 01238



Thermostatic regulating unit for heating systems.
With pre-formed insulation.
 Max. working pressure: 10 bar.
 Max. working temperature: 100°C.
 Supply: 230 V - 50/60 Hz.
 System side connection: 1" F.
 Boiler side connection: 1 1/2" M.
Centre distance:
125 mm fitted for SEPCOLL.



RH to LH convertible

RH to LH convertible

Code	Connection	Pump		
165600A2L	1" F	UPM3 Auto L 25-70	1	-
165601UPM	1" F	UPML 25-95	1	-

Code	Connection	Pump	Temperature adjustment range		
166600A2L	1" F	UPM3 Auto L 25-70	25-50°C	1	-
166601UPM	1" F	UPML 25-95	25-50°C	1	-
166605A2L	1" F	UPM3 Auto L 25-70	40-70°C	1	-

165

tech. broch. 01255

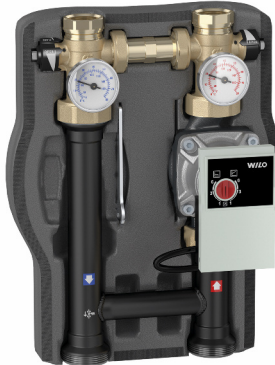

Direct supply unit for heating and air conditioning systems.
With pre-formed insulation.
 Max. working pressure: 10 bar.
 Primary inlet temperature range: 5-100°C.
 Supply: 230 V - 50/60 Hz.
 System side connection: 1" F.
 Boiler side connection: 1 1/2" M.
Centre distance:
125 mm fitted for SEPCOLL.



166



Thermostatic mixing valve.
 Max. working pressure: 10 bar.
 Connections:
 1 1/2" M x 1 1/4" M x 1 1/2" F with captive nut.

Code	Temperature adjustment range	Kv (m³/h)		
166001	25-50°C	4,1	1	-
166005	40-70°C	4,1	1	-

Upward flow - flow on RH side
 Downward flow - flow on LH side

Code	Connection	Pump		
165640WYP	1" F	YONOS PARA 25/6 RKA	1	-
165641UPM	1" F	UPML 25-95	1	-

Upward flow - flow on LH side
 Downward flow - flow on RH side

Code	Connection	Pump		
165650WYP	1" F	YONOS PARA 25/6 RKA	1	-
165651UPM	1" F	UPML 25-95	1	-

Spare parts for regulating units
 165, 166 and 167 series.

Code	Description
R19441	YONOS PARA 25-6 RKA pump
F19486	UPML 25-95 pump
F19101/R	flow temperature gauge
F19101/BL	return temperature gauge
R12090	spare spanner for 165 series
F000566	UPM3 Auto L 25-70 pump

MOTORIZED REGULATING UNITS

167

tech. broch. 01239



Motorised regulating unit for heating systems.
With pre-formed insulation.
 Regulation with sector three-way valve and 3-point actuator.
 With auxiliary microswitch.
 Can be connected to digital regulators code 161010 and 1520 series.
 Max. working pressure: 10 bar.
 Max. working temperature: 100°C.
 Supply: 230 V - 50/60 Hz.
 Operating time: 50 s (90° rotation).
 System side connection: 1" F.
 Boiler side connection: 1 1/2" M.
Centre distance: 125 mm fitted for SEPCOLL.



Upward flow - flow on RH side
 Downward flow - flow on LH side

Code	Connection	Pump		
167600A2L	1" F	UPM3 Auto L 25-70	1	-
167601UPM	1" F	UPML 25-95	1	-

Upward flow - flow on LH side
 Downward flow - flow on RH side

Code	Connection	Pump		
167610A2L	1" F	UPM3 Auto L 25-70	1	-
167611UPM	1" F	UPML 25-95	1	-

167

tech. broch. 01254



Motorised regulating unit for heating and air conditioning systems.
With pre-formed insulation.
 Regulation with sector three-way valve and 3-point actuator.
 With auxiliary microswitch.
 Can be connected to digital regulators code 161010 and 1520 series.
 Max. working pressure: 10 bar.
 Primary inlet temperature range: 5-100°C.
 Supply: 230 V - 50/60 Hz.
 Operating time: 50 s (90° rotation).
 System side connection: 1" F.
 Boiler side connection: 1 1/2" M.
Centre distance: 125 mm fitted for SEPCOLL.



Upward flow - flow on RH side
 Downward flow - flow on LH side

Code	Connection	Pump		
167640WYP	1" F	YONOS PARA 25/6 RKA	1	-
167641UPM	1" F	UPML 25-95	1	-

Upward flow - flow on LH side
 Downward flow - flow on RH side

Code	Connection	Pump		
167650WYP	1" F	YONOS PARA 25/6 RKA	1	-
167651UPM	1" F	UPML 25-95	1	-

Application diagrams of regulating unit 165 series and motorised regulating unit 167 series

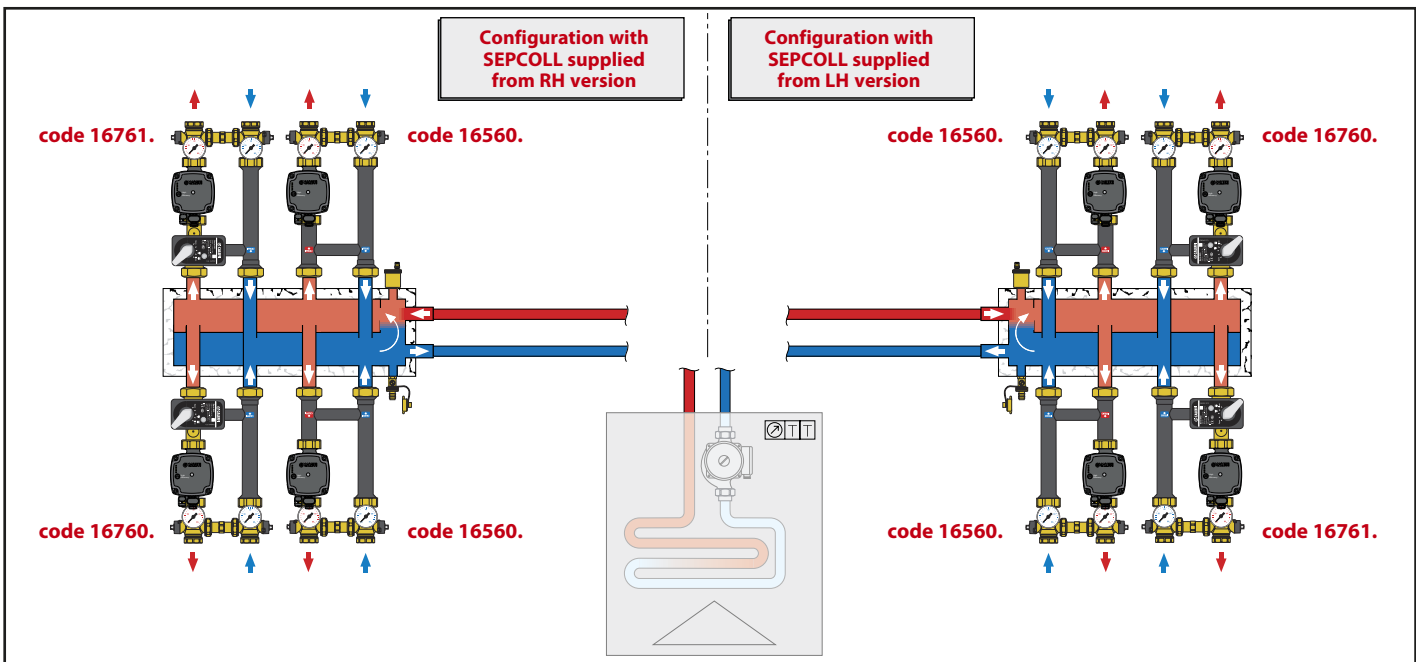

SPARE PARTS AND ACCESSORIES FOR UNITS 165 - 166 - 167 SERIES



167

Sector three-way valve (equipercentage/linear regulation) and 3-pointt actuator.
Right-hand version.
 Max. working pressure: 10 bar.
 Max. working temperature: 100°C.
 Connections:
 1 1/2" M x 1 1/4" M x 1 1/2" F captive nut.

Code	Kv (m³/h)		
167032	6,3	1	-



167

Sector three-way valve (equipercentage/linear regulation) and 3-pointt actuator.
Left-hand version.
 Max. working pressure: 10 bar.
 Max. working temperature: 100°C.
 Connections:
 1 1/2" M x 1 1/4" M x 1 1/2" F captive nut.

Code	Kv (m³/h)		
167042	6,3	1	-

Spare actuator for regulating units 167 series.

Code		Supply voltage V		
167012	right-hand version	230	1	-
167022	left-hand version	230	1	-
167014	right-hand version	24	1	-
167024	left-hand version	24	1	-



165

Mounting bracket in stainless steel for units 165, 166 and 167 series.

Code			
165001		1	-



519

Differential by-pass valve for units 165, 166 and 167 series.
 Max. working pressure: 10 bar.
 Max. working temperature: 100°C.

Code	Setting range m w.g.		
519006	0,2-3	1	-



165

Pair of eccentric tailpieces for units 165, 166 and 167 series.
 Centre distance: 105-145 mm.

Code			
165006	1 1/2" F x 1" F	1	-



165

Safety thermostat kit for units 165, 166 and 167 series.
 Protection class: IP 65.
 M4 threading.

Code		Setting		
165004	Max. temperature safety thermostat	55°C ±3	1	-
165007	Min. temperature safety thermostat	10°C ±3	1	-



165

Sensor holder extension for units 165, 166 and 167 series.
 Side connections:
 M4 F x M4 F x 1/8" F x 1/4" F.

Code			
165003	1" M x 1" F	1	-



165

Female union with captive nut complete with gasket for units 165, 166 and 167 series.

Code			
165002	1 1/2" F x 1" F	1	-



165

Hydraulic separator kit for units 165, 166 and 167 series.

Code			
165010	1 1/2" F x 1" F	1	-

TEMPERATURE REGULATORS



161

Digital regulator with synoptic diagram for heating and cooling complete with immersion flow probes with pocket and Pt1000 Ø 6 mm return probe. Optional outside compensated probe. Temperature adjustment range: 5–95°C. Supply: 230 V - 50/60 Hz. Protection class: IP 20 / EN 60529. Probe cable length: 1,5 m.



Code

161010



1 -

For accessories see page 107



1520

Digital temperature controller for heating and cooling. Complete with flow probe, outside probe and max. relative humidity probe. Supply: 230 V - 50/60 Hz. Power consumption: 5,5 VA. Protection class: IP 40.

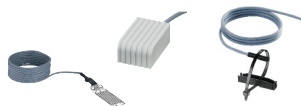

Code

152021 1 channel



1 -



1520

Outside compensated digital temperature regulator. Complete with contact flow probe and outside probe. Adjustment range: 20–90°C. Supply: 230 V - 50/60 Hz. Protection class: IP 40.



Code

152001 1 channel



1 -

152002 2 channels

1 -

152003 3 channels

1 -

Application diagram of regulator 1520 series

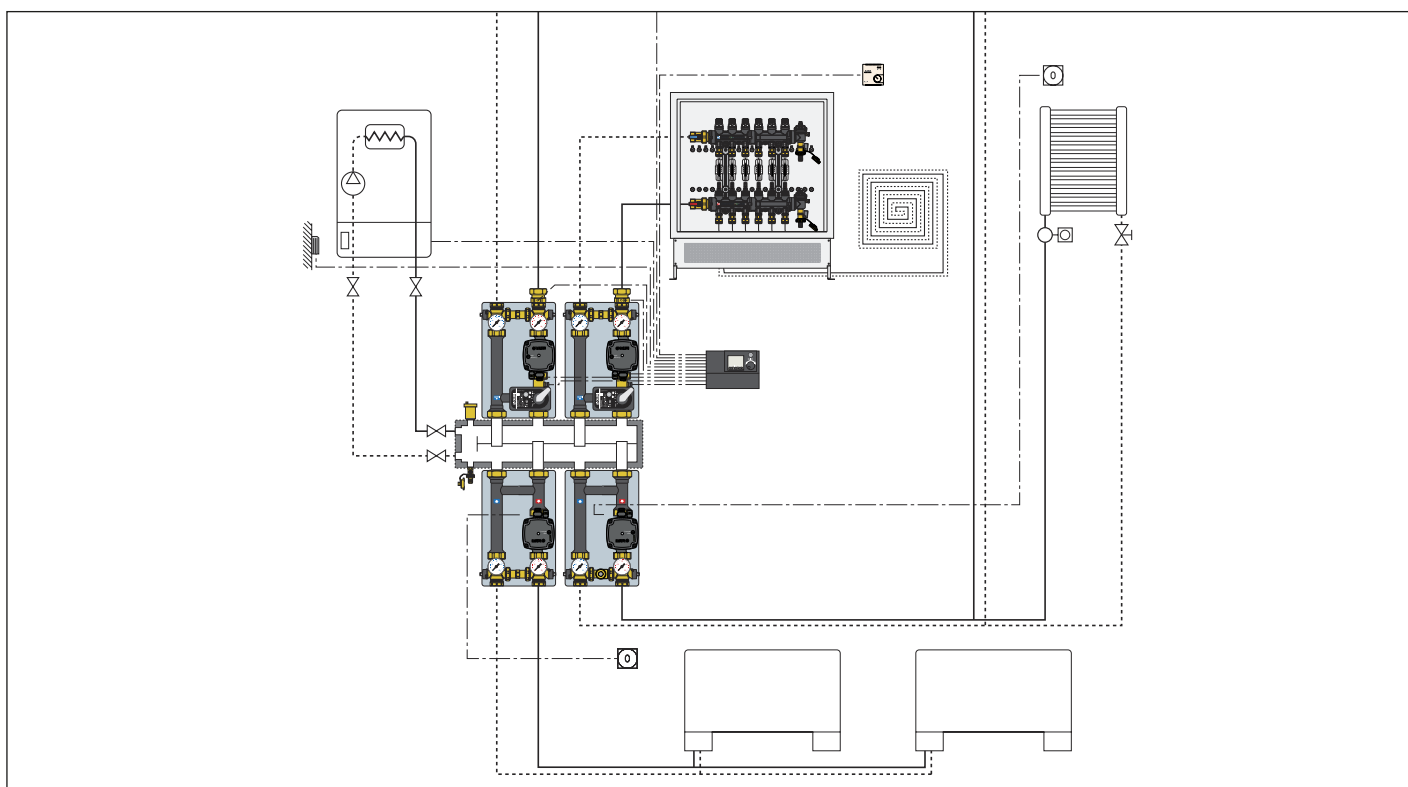

MODULATING TEMPERATURE REGULATING UNIT WITH DIGITAL REGULATOR

NEW

171

tech. broch. 01331



Modulating temperature regulating unit. Pre-assembled in inspection wall box. Equipped with:

- temperature regulating unit with compensated set point digital regulator, convertible outside compensated,
- panel manifolds with built-in flow meters and shut-off valves,
- primary circuit by-pass kit,
- primary circuit shut-off valves,
- high-efficiency pump,
- inspection wall box, with floor supports.

Max. working pressure: 6 bar.
Adjustment temperature range: 5–95°C.
Supply: 230 V - 50/60 Hz.



Code	Conn.	Outlet No.	Outlets	Box length (mm)		
1715C5A2L	3/4" M	x 3	3/4" M	600	1	–
1715D5A2L	3/4" M	x 4	3/4" M	600	1	–
1715E5A2L	3/4" M	x 5	3/4" M	800	1	–
1715F5A2L	3/4" M	x 6	3/4" M	800	1	–
1715G5A2L	3/4" M	x 7	3/4" M	800	1	–
1715H5A2L	3/4" M	x 8	3/4" M	800	1	–
1715I5A2L	3/4" M	x 9	3/4" M	1000	1	–
1715L5A2L	3/4" M	x 10	3/4" M	1000	1	–
1715M5A2L	3/4" M	x 11	3/4" M	1000	1	–
1715N5A2L	3/4" M	x 12	3/4" M	1200	1	–
1715O5A2L	3/4" M	x 13	3/4" M	1200	1	–

MODULATING TEMPERATURE REGULATING UNIT WITH DIGITAL REGULATOR AND MEDIUM DISTRIBUTION KIT FOR PRIMARY CIRCUIT

NEW

171

tech. broch. 01331

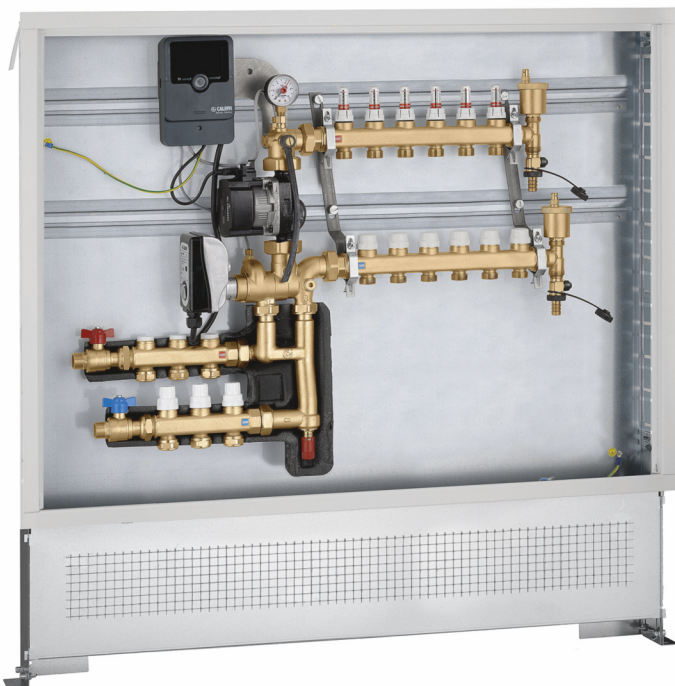

Modulating temperature regulating unit. Pre-assembled in inspection wall box. Equipped with:

- temperature regulating unit with compensated set point digital regulator, convertible outside compensated,
- medium distribution kit with built-in lockshields and shut-off valves for primary circuit,
- panel manifolds with built-in flow meters and shut-off valves,
- primary circuit by-pass kit,
- primary circuit shut-off valves,
- high-efficiency pump,
- inspection wall box, with floor supports.

Max. working pressure: 6 bar.
Adjustment temperature range: 5–95°C.
Supply: 230 V - 50/60 Hz.





Code	Conn.	Outlet No. to panels	Outlet No. to radiators	Box length (mm)		
1715E5A2L 003	3/4" M	5 x 3/4" M	3 x 3/4" M	800	1	–
1715F5A2L 003	3/4" M	6 x 3/4" M	3 x 3/4" M	1000	1	–
1715G5A2L 003	3/4" M	7 x 3/4" M	3 x 3/4" M	1000	1	–
1715H5A2L 003	3/4" M	8 x 3/4" M	3 x 3/4" M	1000	1	–
1715I5A2L 003	3/4" M	9 x 3/4" M	3 x 3/4" M	1000	1	–
1715L5A2L 003	3/4" M	10 x 3/4" M	3 x 3/4" M	1200	1	–
1715M5A2L 003	3/4" M	11 x 3/4" M	3 x 3/4" M	1200	1	–
1715N5A2L 003	3/4" M	12 x 3/4" M	3 x 3/4" M	1200	1	–

**ACCESSORIES AND SPARE PARTS
FOR MODULATING TEMPERATURE REGULATING UNIT**





161
Outside compensated temperature probe.

Code  
161002 1 -



161
Remote regulator.
Functions:
- translation of the regulating curves, from +15 K to -15 K,
- maximum temperature,
- OFF position.

Code  
161005 1 -



161
Pressure safety switch complete with cable for wiring.
Working range: 0,5-10 bar.
Max. working temperature: 100°C.
Cable length: 1 m.

Code  
161003 1 -

Application diagram with code 161003

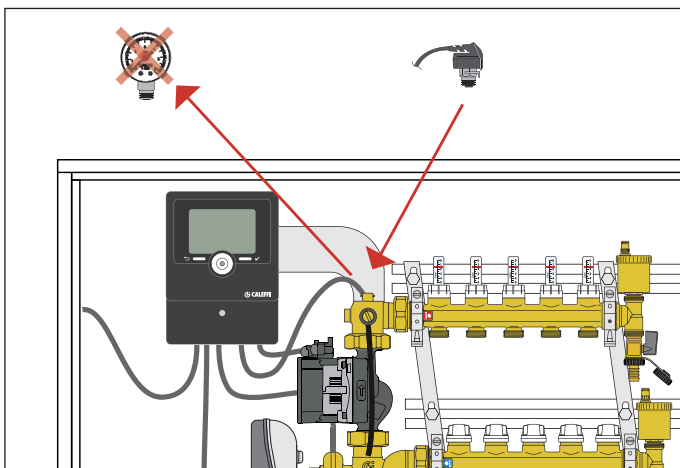

Application diagram with code 161005

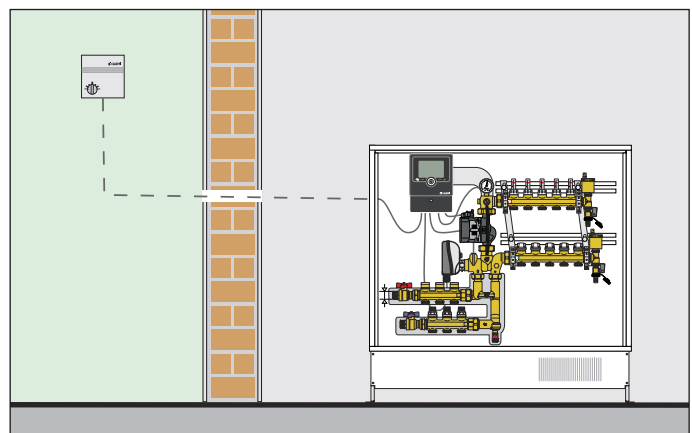

Accessories for regulator code 161010.

Code	Description
161012	Pt1000 contact probe for pipes Ø 6 mm, cable L 2,5 m
161013	immersion pocket for Pt1000 probe 1/2" M, 60 mm
161014	immersion pocket for Pt1000 probe 1/2" M, 100 mm
161015	Pt1000 probe Ø 6 mm - L 20 mm, cable L 1,5 m
161006	Pt1000 probe Ø 6 mm - L 45 mm, cable L 2,5 m



161
Dew point detector.
Working range: 30-100 UR%.

Code  
161004 1 -

**Spare parts for regulating units
code 1715.5A2L.**

Code	Description
161010	digital regulator
F19223	mixing valve group with actuator support
645312	actuator for mixing valve for code 1715.5A2L
F0000566	UPM3 Auto L 25-70 pump
F0000560	pocket 1/8" Ø 6 mm for probe Pt1000 L 20 mm
161015	probe Pt1000 Ø 6 mm - L 20 mm, L cable 1,5 m

NEW



161
Centralised probe
for regulator 161 series.

Code  
161020 1 -

TRANSFORMATION

Transformation from modulating for heating to modulating for heating and cooling with code 161004

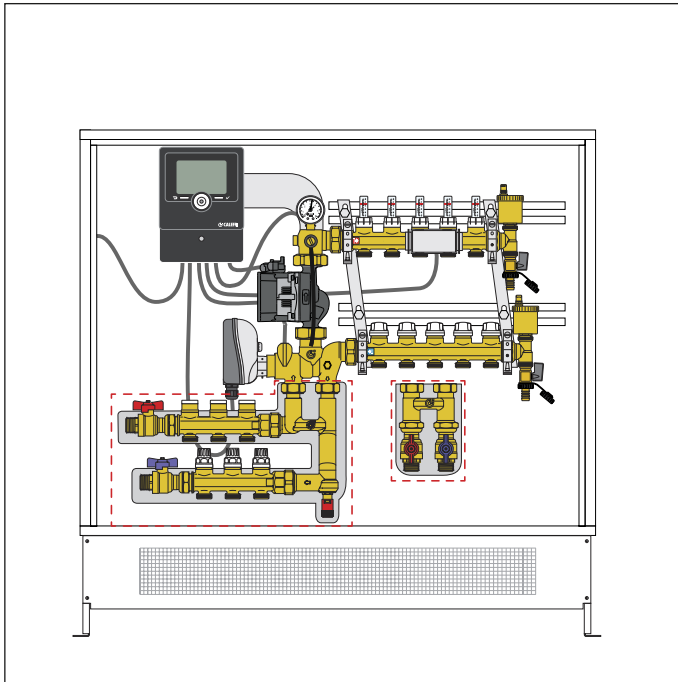

Transformation from modulating for heating to compensated temperature for heating and cooling with codes 161002 and 161004

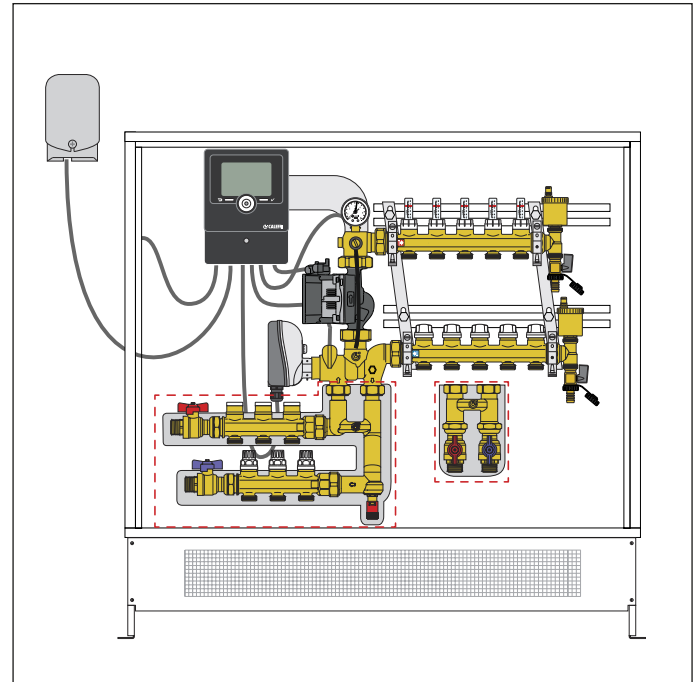

Transformation from modulating for heating to compensated temperature for heating with code 161002

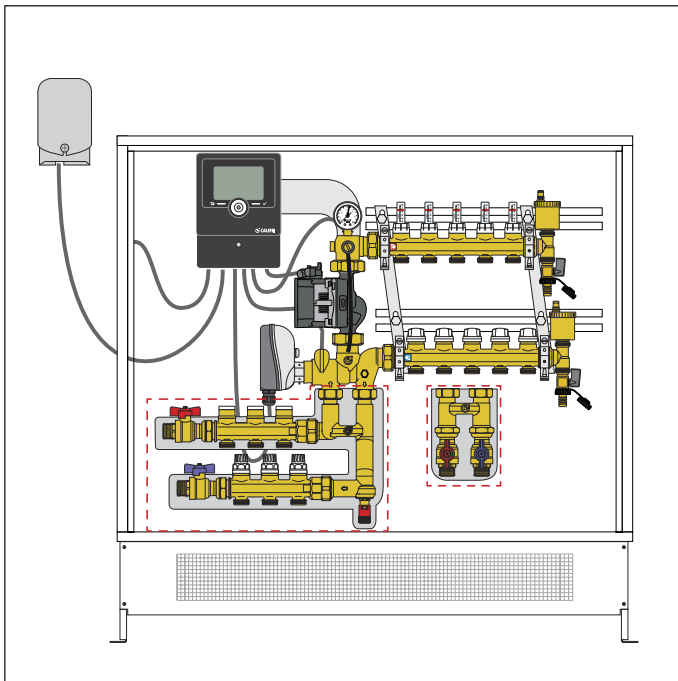

SET POINT THERMOSTATIC REGULATING UNIT





172

tech. broch. 01155

Set point regulating unit.
 Pre-assembled in inspection wall box. Equipped with:
 - set point thermostatic regulating unit,
 - panel manifolds with built-in flow meters and shut-off valves and differential by-pass kit,
 - primary circuit by-pass kit,
 - primary circuit shut-off valves,
 - safety thermostat,
 - high-efficiency pump, UPM3 Auto L 25-70,
 - inspection wall box, with floor supports.
 Max. working pressure: 10 bar.
 Adjustment temperature range: 25–55°C.
 Supply: 230 V - 50/60 Hz.



Code	Conn.	Outlet No.	Outlets	Box length (mm)		
1725C1A2L	3/4" M	x 3	3/4" M	600	1	-
1725D1A2L	3/4" M	x 4	3/4" M	600	1	-
1725E1A2L	3/4" M	x 5	3/4" M	800	1	-
1725F1A2L	3/4" M	x 6	3/4" M	800	1	-
1725G1A2L	3/4" M	x 7	3/4" M	800	1	-
1725H1A2L	3/4" M	x 8	3/4" M	1000	1	-
1725I1A2L	3/4" M	x 9	3/4" M	1000	1	-
1725L1A2L	3/4" M	x 10	3/4" M	1000	1	-
1725M1A2L	3/4" M	x 11	3/4" M	1000	1	-
1725N1A2L	3/4" M	x 12	3/4" M	1200	1	-
1725O1A2L	3/4" M	x 13	3/4" M	1200	1	-

SET POINT THERMOSTATIC REGULATING UNIT WITH MEDIUM DISTRIBUTION KIT FOR PRIMARY CIRCUIT

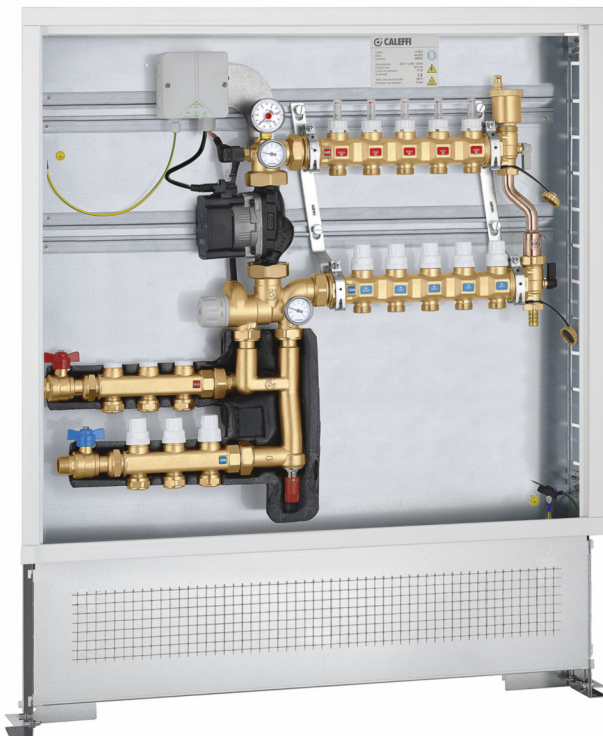



172

tech. broch. 01156

Set point regulating unit.
 Pre-assembled in inspection wall box. Equipped with:
 - set point thermostatic regulating unit,
 - medium distribution kit with built-in lockshields and shut-off valves for primary circuit,
 - panel manifolds with built-in flow meters and shut-off valves and differential by-pass kit,
 - primary circuit by-pass kit,
 - primary circuit shut-off valves,
 - safety thermostat,
 - high-efficiency pump, UPM3 Auto L 25-70,
 - inspection wall box, with floor supports.
 Max. working pressure: 10 bar.
 Adjustment temperature range: 25–55°C.
 Supply: 230 V - 50/60 Hz.



Code	Conn.	Outlet No. to panels	Outlet No. to radiators	Box length (mm)		
1725C1A2L 003	3/4" M	3 x 3/4" M	3 x 3/4" M	800	1	-
1725D1A2L 003	3/4" M	4 x 3/4" M	3 x 3/4" M	800	1	-
1725E1A2L 003	3/4" M	5 x 3/4" M	3 x 3/4" M	800	1	-
1725F1A2L 003	3/4" M	6 x 3/4" M	3 x 3/4" M	1000	1	-
1725G1A2L 003	3/4" M	7 x 3/4" M	3 x 3/4" M	1000	1	-
1725H1A2L 003	3/4" M	8 x 3/4" M	3 x 3/4" M	1000	1	-
1725I1A2L 003	3/4" M	9 x 3/4" M	3 x 3/4" M	1200	1	-
1725L1A2L 003	3/4" M	10 x 3/4" M	3 x 3/4" M	1200	1	-
1725M1A2L 003	3/4" M	11 x 3/4" M	3 x 3/4" M	1200	1	-
1725N1A2L 003	3/4" M	12 x 3/4" M	3 x 3/4" M	1200	1	-

SET POINT THERMOSTATIC REGULATING UNIT



182

tech. broch. 01190

Set point regulating unit.

Pre-assembled in inspection wall box. Equipped with:



- set point thermostatic regulating unit,
- distribution manifolds in composite with built-in flow meters and shut-off valves,
- safety thermostat,
- high-efficiency pump, UPM3 Auto L 25-70,
- inspection wall box, with floor supports.

Max. working pressure: 6 bar.

Adjustment temperature range: 25–55°C.

Supply: 230 V - 50/60 Hz.



Code	Conn.	Outlet No.	Outlets	Box length (mm)		
1825C1A2L	3/4" M	x 3	3/4" M	600	1	–
1825D1A2L	3/4" M	x 4	3/4" M	600	1	–
1825E1A2L	3/4" M	x 5	3/4" M	600	1	–
1825F1A2L	3/4" M	x 6	3/4" M	800	1	–
1825G1A2L	3/4" M	x 7	3/4" M	800	1	–
1825H1A2L	3/4" M	x 8	3/4" M	800	1	–
1825I1A2L	3/4" M	x 9	3/4" M	800	1	–
1825L1A2L	3/4" M	x 10	3/4" M	1000	1	–
1825M1A2L	3/4" M	x 11	3/4" M	1000	1	–
1825N1A2L	3/4" M	x 12	3/4" M	1200	1	–
1825O1A2L	3/4" M	x 13	3/4" M	1200	1	–

SET POINT THERMOSTATIC REGULATING UNIT WITH MEDIUM DISTRIBUTION KIT FOR PRIMARY CIRCUIT



182

tech. broch. 01192

Set point regulating unit.

Pre-assembled in inspection wall box. Equipped with:



- set point thermostatic regulating unit,
- medium distribution kit with built-in lockshields and shut-off valves for primary circuit,
- distribution manifolds in composite with built-in flow meters and shut-off valves,
- primary circuit by-pass kit,
- safety thermostat,
- high-efficiency pump, UPM3 Auto L 25-70,
- inspection wall box, with floor supports.

Max. working pressure: 6 bar.

Adjustment temperature range: 25–55°C.

Supply: 230 V - 50/60 Hz.



Code	Conn.	Outlet No. to panels	Outlet No. to radiators	Box length (mm)		
1826C1A2L 002	1" F	3 x 3/4" M	2 x 3/4" M	800	1	–
1826D1A2L 002	1" F	4 x 3/4" M	2 x 3/4" M	800	1	–
1826E1A2L 002	1" F	5 x 3/4" M	2 x 3/4" M	800	1	–
1826F1A2L 002	1" F	6 x 3/4" M	2 x 3/4" M	1000	1	–
1826G1A2L 002	1" F	7 x 3/4" M	2 x 3/4" M	1000	1	–
1826H1A2L 002	1" F	8 x 3/4" M	2 x 3/4" M	1000	1	–
1826I1A2L 002	1" F	9 x 3/4" M	2 x 3/4" M	1000	1	–
1826L1A2L 002	1" F	10 x 3/4" M	2 x 3/4" M	1000	1	–
1826M1A2L 002	1" F	11 x 3/4" M	2 x 3/4" M	1200	1	–
1826N1A2L 002	1" F	12 x 3/4" M	2 x 3/4" M	1200	1	–
1826O1A2L 002	1" F	13 x 3/4" M	2 x 3/4" M	1200	1	–

SET POINT THERMOSTATIC REGULATING UNIT

182

tech. broch. 01190

Pre-assembled set point thermostatic regulating unit.

Equipped with:

- set point thermostatic regulating unit,
- distribution manifolds in composite with built-in flow meters and shut-off valves,
- safety thermostat,
- high efficiency pump, UPM3 Auto L 25-70.

Max. working pressure: 6 bar.

Adjustment temperature range: 25–55°C.

Supply: 230 V - 50/60 Hz.

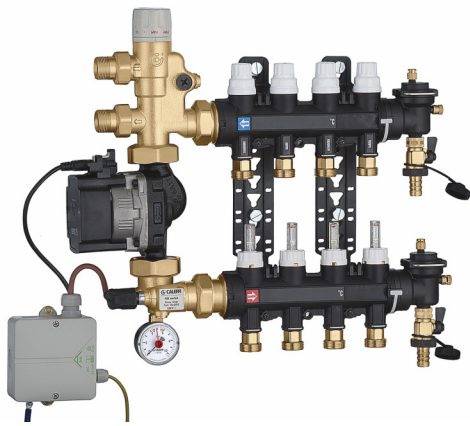

Code	Conn.	Outlet No.	Outlets	Box choice (mm)		
1825C5A2L	3/4" M	x 3	3/4" M	600	1	–
1825D5A2L	3/4" M	x 4	3/4" M	600	1	–
1825E5A2L	3/4" M	x 5	3/4" M	600	1	–
1825F5A2L	3/4" M	x 6	3/4" M	800	1	–
1825G5A2L	3/4" M	x 7	3/4" M	800	1	–
1825H5A2L	3/4" M	x 8	3/4" M	800	1	–
1825I5A2L	3/4" M	x 9	3/4" M	800	1	–
1825L5A2L	3/4" M	x 10	3/4" M	1000	1	–
1825M5A2L	3/4" M	x 11	3/4" M	1000	1	–
1825N5A2L	3/4" M	x 12	3/4" M	1200	1	–
1825O5A2L	3/4" M	x 13	3/4" M	1200	1	–

182

tech. broch. 01192

Pre-assembled set point regulating unit.

Equipped with:

- thermostatic set point regulating unit,
- medium distribution kit with built-in lockshields and shut-off valves for primary circuit,
- distribution manifolds in composite with built-in flow meters and shut-off valves,
- primary circuit by-pass kit,
- safety thermostat,
- high-efficiency pump, UPM3 Auto L 25-70.

Max. working pressure: 6 bar.

Adjustment temperature range: 25–55°C.

Supply: 230 V - 50/60 Hz.

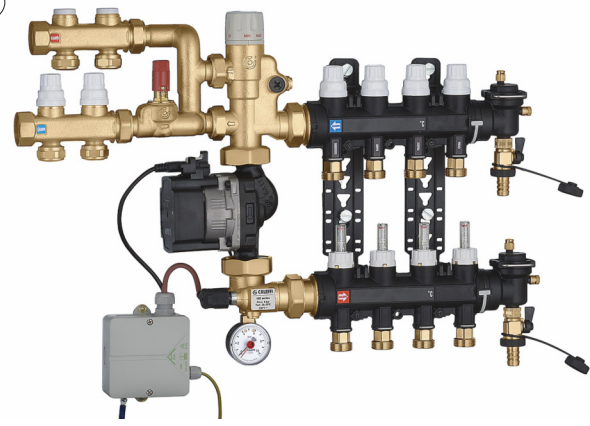

Code	Conn.	Outlet No. to panels	Outlet No. to radiators	Box choice (mm)		
1826C5A2L 002	1" F	3 x 3/4" M	2 x 3/4" M	800	1	–
1826D5A2L 002	1" F	4 x 3/4" M	2 x 3/4" M	800	1	–
1826E5A2L 002	1" F	5 x 3/4" M	2 x 3/4" M	800	1	–
1826F5A2L 002	1" F	6 x 3/4" M	2 x 3/4" M	1000	1	–
1826G5A2L 002	1" F	7 x 3/4" M	2 x 3/4" M	1000	1	–
1826H5A2L 002	1" F	8 x 3/4" M	2 x 3/4" M	1000	1	–
1826I5A2L 002	1" F	9 x 3/4" M	2 x 3/4" M	1000	1	–
1826L5A2L 002	1" F	10 x 3/4" M	2 x 3/4" M	1000	1	–
1826M5A2L 002	1" F	11 x 3/4" M	2 x 3/4" M	1200	1	–
1826N5A2L 002	1" F	12 x 3/4" M	2 x 3/4" M	1200	1	–
1826O5A2L 002	1" F	13 x 3/4" M	2 x 3/4" M	1200	1	–

661

Box for manifolds 662, 671 and 668...S1 series and regulating units 182 series. Closure with a push-fit clamp. In painted sheet steel. With supports for installation on floor. Adjustable depth from 110 to 150 mm. Adjustable height from 270 a 410 mm.



Code	Dim. (h x w x d)		
661045	500 x 400 x 110–150	1	–
661065	500 x 600 x 110–150	1	–
661085	500 x 800 x 110–150	1	–
661105	500 x 1000 x 110–150	1	–
661125	500 x 1200 x 110–150	1	–

182

Differential by-pass kit with fixed setting 25 kPa (2.500 mm w.g.) complete with flexible hose. For regulating units 182 series and manifolds 670 and 671 series. Max. working pressure: 10 bar. Temperature range: 0–100°C.



Code	Conn.		
182000	3/4"	1	5

SET POINT THERMOSTATIC REGULATING UNIT

182

Set point regulating unit.
Pre-assembled in inspection wall box. Equipped with:

- set point thermostatic regulating unit,
- return manifold with built-in shut-off valves fitted for thermo-electric actuator;
- flow manifold complete with flow meters with 0-5 l/m scale and flow rate balancing valves;
- end fittings with automatic air vent and drain cock;
- safety thermostat,
- high-efficiency pump, UPM3 Auto L 25-70,
- inspection wall box, with floor supports.

Max. working pressure: 6 bar.
Adjustment temperature range: 25-55°C.
Supply: 230 V - 50/60 Hz.

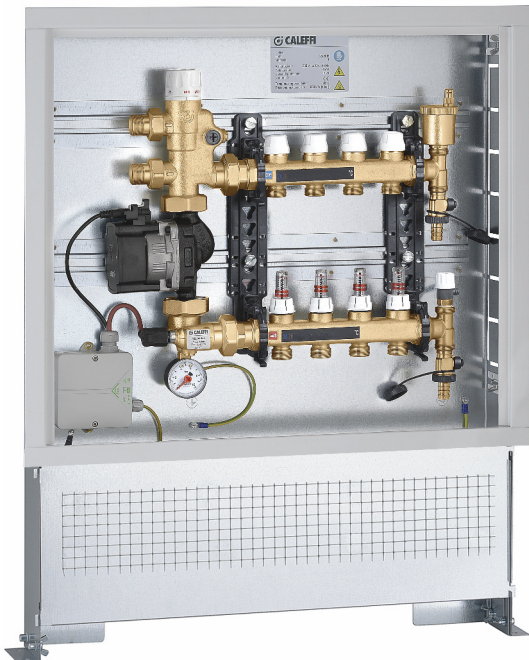

Code	Conn.	Outlet No.	Outlets	Box length (mm)		
1825C7A2L	3/4" M	x 3	3/4" M	600	1	-
1825D7A2L	3/4" M	x 4	3/4" M	600	1	-
1825E7A2L	3/4" M	x 5	3/4" M	600	1	-
1825F7A2L	3/4" M	x 6	3/4" M	800	1	-
1825G7A2L	3/4" M	x 7	3/4" M	800	1	-
1825H7A2L	3/4" M	x 8	3/4" M	800	1	-
1825I7A2L	3/4" M	x 9	3/4" M	800	1	-
1825L7A2L	3/4" M	x 10	3/4" M	1000	1	-
1825M7A2L	3/4" M	x 11	3/4" M	1000	1	-
1825N7A2L	3/4" M	x 12	3/4" M	1000	1	-
1825O7A2L	3/4" M	x 13	3/4" M	1000	1	-

182

tech. broch. 01190

Pre-assembled set point regulating unit.
Equipped with:

- set point thermostatic regulating unit,
- safety thermostat,
- high-efficiency pump, UPM3 Auto L 25-70.

Max. working pressure: 10 bar.
Adjustment temperature range: 25-55°C.
Supply: 230 V - 50/60 Hz.



Code	Connections		
182521A2L	3/4" M	1	-

182

tech. broch. 01192

Pre-assembled set point regulating unit.
Equipped with:

- set point thermostatic regulating unit,
- medium distribution kit with built-in lockshields and shut-off valves for primary circuit,
- primary circuit by-pass kit,
- safety thermostat,
- high-efficiency pump, UPM3 Auto L 25-70.

Max. working pressure: 10 bar.
Adjustment temperature range: 25-55°C.
Supply: 230 V - 50/60 Hz.

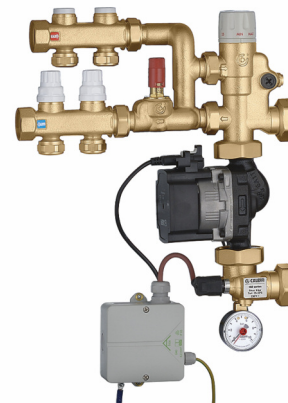

Code	Connections	Outlets		
182621A2L 002	1" F	2	1	-
182621A2L 003	1" F	3	1	-

675

Pair of fittings with seals for connection of 182 series groups to 662 and 664 series manifolds.



Code	Connections		
675005	1 1/4" M x 1" M	1	-

675

Pair of fittings with seals for connection of 182 series groups to 670 and 671 series manifolds.



Code	Connections		
675004	1 1/4" M x 1 1/4" M	1	-

Spare parts for regulating units 172 and 182 series.

R19093	safety thermostat
F19223	thermostatic mixing valve group for 172 series
F19267	thermostatic mixing valve group for 182 series
F39344	temperature gauge 0-80°C
F0000566	UPM3 Auto L 25-70 pump

THERMOSTATIC MIXING VALVE FOR RADIANT PANEL SYSTEMS

NEW



5202



Adjustable thermostatic mixing valve with knob.
For radiant panel systems.
CR dezincification resistant alloy body.
Max. working pressure: 10 bar.
Max. inlet temperature: 90°C.

Operating principle

The purpose of the thermostatic mixing valve is to adjust the temperature of the medium supplied to the radiant panels.
The thermostatic mixing valve mixes the hot and cold water at the inlet so as to maintain the mixed water constantly at the set temperature at the outlet. A thermostatic element is fully immersed in the mixed water flow. It contracts or expands, moving an obturator which controls the passage of hot or cold water at the inlet. If the inlet temperature changes, the internal element automatically reacts to restore the set temperature at the outlet. A circulator must be installed downstream of the mixing valve so as to allow correct distribution of the medium at the radiant panel system manifold.

Code	DN	Conn.	Temperature adjustment		
520251	20	3/4" M	20-43°C	1	10
520261	25	1" M	20-43°C	1	5

Application diagram of mixing valve 5202 series

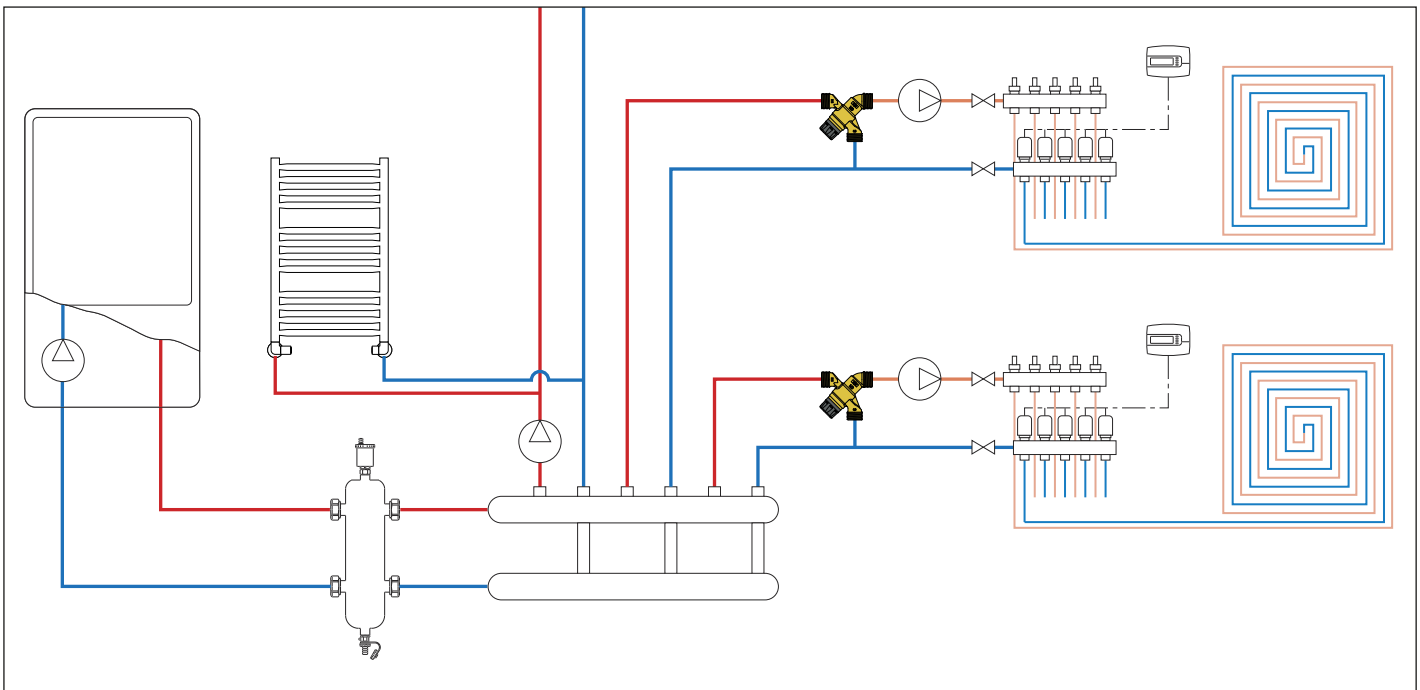

DISTRIBUTION MANIFOLDS FOR RADIANT PANEL SYSTEMS

This diagram is just an indication

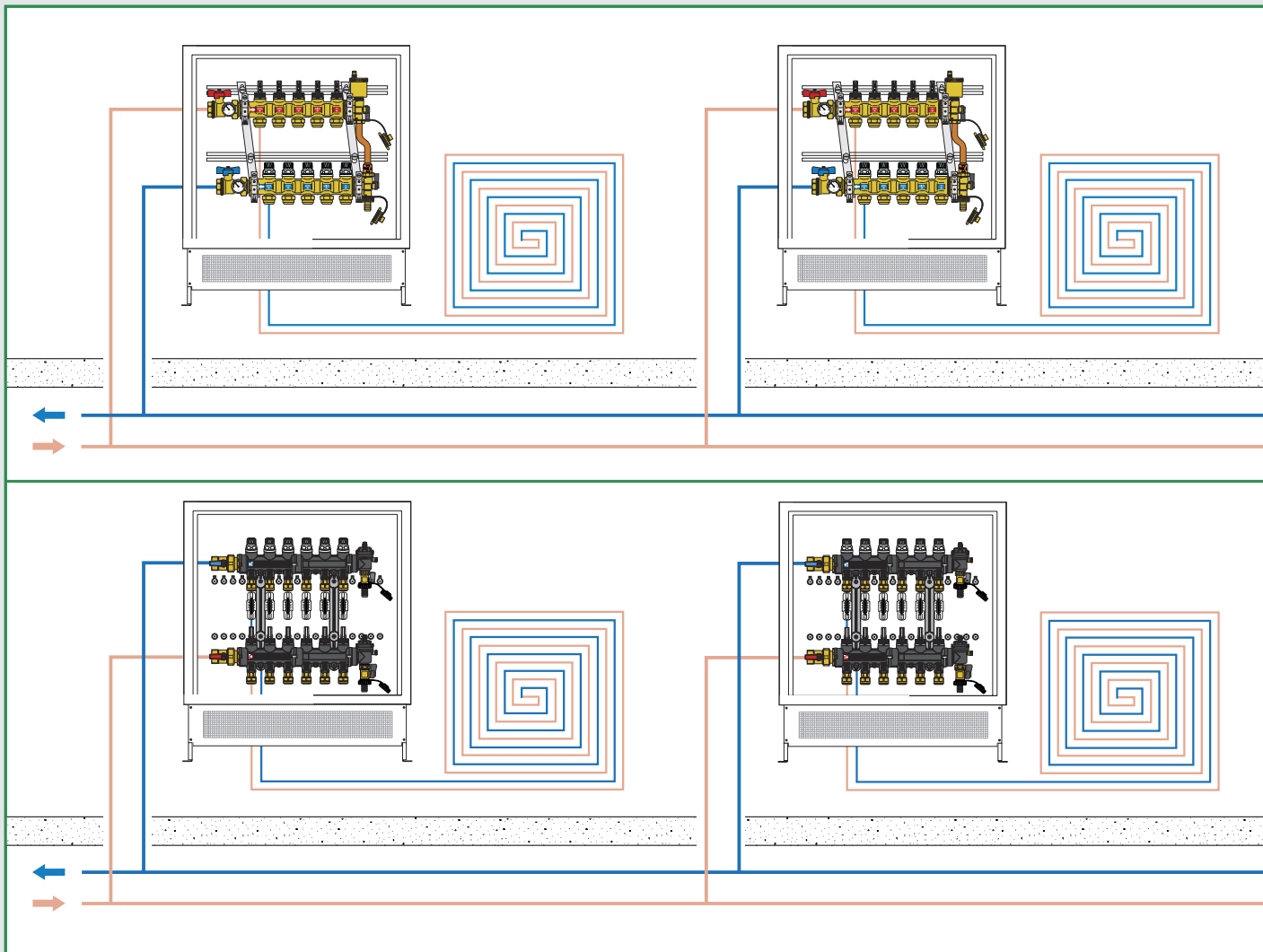

Composite distribution manifolds

Brass distribution manifolds for radiant panel systems

Differential pressure regulating valve for distribution manifolds

Boxes for distribution manifolds

Thermo-electric actuators

Control bar

COMPOSITE DISTRIBUTION MANIFOLDS

670



Pre-assembled distribution manifold.
Max. working pressure: 6 bar.
Temperature range: 5–60°C.

tech. broch. 01126

Equipped with:

- technopolymer flow manifold with built-in flow meters and flow rate balancing valves;
- technopolymer return manifold with built-in shut-off valves fitted for thermo-electric actuator;
- technopolymer end fittings with automatic air vent with hygroscopic cap, discharge valve and fill/drain cock;
- pair of ball shut-off valves;
- LCD thermometers on flow and return manifolds;
- adhesive labels indicating the rooms;
- pair of mounting brackets for box installation;
- box with adjustable height and depth;
- coupling adapter with clip code 675850, for manifold outlets (in package);
- template for cutting pipe code 675002 (in package).



Code	Conn.	Outlet No.	Outlets	Box length (mm)		
6706C1	1" F	x 3	3/4" M	600	1	–
6706D1	1" F	x 4	3/4" M	600	1	–
6706E1	1" F	x 5	3/4" M	600	1	–
6706F1	1" F	x 6	3/4" M	600	1	–
6706G1	1" F	x 7	3/4" M	800	1	–
6706H1	1" F	x 8	3/4" M	800	1	–
6706I1	1" F	x 9	3/4" M	800	1	–
6706L1	1" F	x 10	3/4" M	800	1	–
6706M1	1" F	x 11	3/4" M	800	1	–
6706N1	1" F	x 12	3/4" M	800	1	–



671

Pre-assembled distribution manifold.
Max. working pressure: 6 bar.
Temperature range: 5–60°C.

Equipped with:

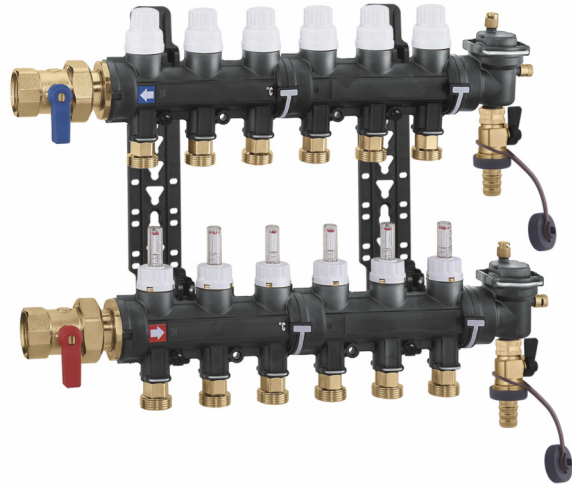
- technopolymer flow manifold with built-in flow meters and flow rate balancing valves;
- technopolymer return manifold with built-in shut-off valves fitted for thermo-electric actuator;
- technopolymer end fittings with automatic air vent with hygroscopic cap, discharge valve and fill/drain cock;
- pair of ball shut-off valves;
- LCD thermometers on flow and return manifolds;
- adhesive labels indicating the rooms;
- pair of mounting brackets for box or wall mounting;
- coupling adapter with clip code 675850, for manifold outlets (in package);
- template for cutting pipe code 675002 (in package).



Code	Connections	Outlet No.	Outlets	Box choice (mm)		
6716C1	1" F	x 3	3/4" M	600	1	–
6716D1	1" F	x 4	3/4" M	600	1	–
6716E1	1" F	x 5	3/4" M	600	1	–
6716F1	1" F	x 6	3/4" M	600	1	–
6716G1	1" F	x 7	3/4" M	600	1	–
6716H1	1" F	x 8	3/4" M	800	1	–
6716I1	1" F	x 9	3/4" M	800	1	–
6716L1	1" F	x 10	3/4" M	800	1	–
6716M1	1" F	x 11	3/4" M	800	1	–
6716N1	1" F	x 12	3/4" M	800	1	–
6716O1	1" F	x 13	3/4" M	–	1	–
6716P1	1" F	x 14	3/4" M	–	1	–

ACCESSORIES FOR COMPOSITE DISTRIBUTION MANIFOLDS



675

tech. broch. 01126

Technopolymer end fitting with automatic air vent with hygroscopic cap, discharge valve, fill/drain cock. Max. working pressure: 6 bar. Temperature range: 5–60°C.

Code			
675800	1 1/4"	1	20



675

tech. broch. 01126

Cutting pipe template.

Code			
675002		10	-



675

tech. broch. 01126

Push-fit thermometer for panel piping. For pipes with outer diameter from 15 to 18 mm. Thermometer scale: 5–50°C. Thermometer fluid: alcohol. Thermo-conductive paste supplied in package.

Code			
675900		10	100



182

Differential by-pass kit with fixed setting 25 kPa (2.500 mm w.g.) complete with flexible hose. For regulating units 182 series and manifolds 670 and 671 series. Max. working pressure: 10 bar. Temperature range: 0–100°C.

Code			
182000	3/4"	1	5



675

tech. broch. 01126

Coupling adapter with clip.

Code			
675850	3/4" Ø 18 mm	1	40

BRASS DISTRIBUTION MANIFOLDS FOR RADIANT PANEL SYSTEMS

668...S1

tech. broch. 01144

Pre-assembled distribution manifold.
Max. working pressure: 10 bar.
Temperature range: 0–80°C.

Equipped with:

- flow manifold with built-in flow meters and flow rate balancing valves;
- return manifold with built-in shut-off valves fitted for thermo-electric actuator;
- end fittings with multi-position ball valve, automatic air vent and fill/drain hose connection;
- off-centre by-pass kit with fixed setting and with connecting pipe;
- ball shut-off valves;
- mounting brackets for box or wall mounting.

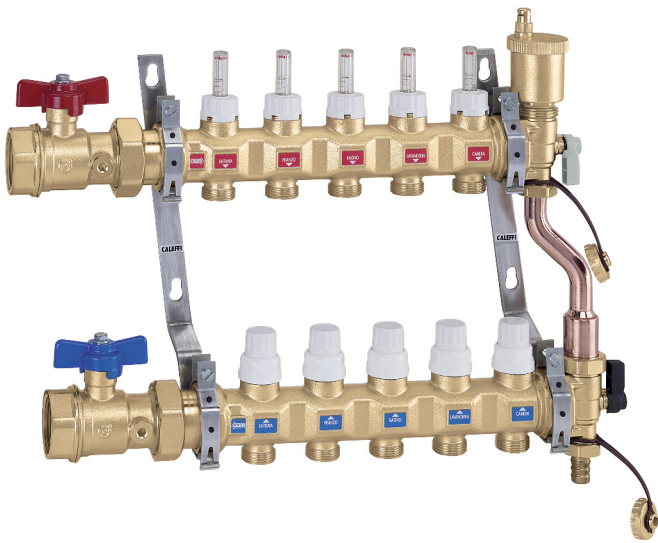

Code	Conn.	Outlet No.	Outlets	Box choice (mm) with / without AUTOFLOW®		
6686C5S1	1" F	x 3	3/4" M	600 / 600	1	–
6686D5S1	1" F	x 4	3/4" M	600 / 600	1	–
6686E5S1	1" F	x 5	3/4" M	600 / 800	1	–
6686F5S1	1" F	x 6	3/4" M	600 / 800	1	–
6686G5S1	1" F	x 7	3/4" M	800 / 800	1	–
6686H5S1	1" F	x 8	3/4" M	800 / 1000	1	–
6686I5S1	1" F	x 9	3/4" M	800 / 1000	1	–
6686L5S1	1" F	x 10	3/4" M	800 / 1000	1	–
6686M5S1	1" F	x 11	3/4" M	1000 / 1000	1	–
6686N5S1	1" F	x 12	3/4" M	1000 / 1200	1	–
6686O5S1	1" F	x 13	3/4" M	1000 / 1200	1	–
6686P5S1	1" F	x 14	3/4" M	1000 / 1200	1	–
6687C5S1	1 1/4" F	x 3	3/4" M	600 / 600	1	–
6687D5S1	1 1/4" F	x 4	3/4" M	600 / 600	1	–
6687E5S1	1 1/4" F	x 5	3/4" M	600 / 800	1	–
6687F5S1	1 1/4" F	x 6	3/4" M	600 / 800	1	–
6687G5S1	1 1/4" F	x 7	3/4" M	800 / 800	1	–
6687H5S1	1 1/4" F	x 8	3/4" M	800 / 1000	1	–
6687I5S1	1 1/4" F	x 9	3/4" M	800 / 1000	1	–
6687L5S1	1 1/4" F	x 10	3/4" M	800 / 1000	1	–
6687M5S1	1 1/4" F	x 11	3/4" M	1000 / 1000	1	–
6687N5S1	1 1/4" F	x 12	3/4" M	1000 / 1200	1	–
6687O5S1	1 1/4" F	x 13	3/4" M	1000 / 1200	1	–
6687P5S1	1 1/4" F	x 14	3/4" M	1000 / 1200	1	–

666...S1

tech. broch. 01144

Return manifold, with built-in shut-off valves fitted for thermo-electric actuator.

Max. working pressure: 10 bar.
Temperature range: 0–80°C.
Outlet centre distance: 50 mm.



Code	Connections	Outlet No.	Outlets		
666735S1	1 1/4" F	x 3	3/4" M	2	12
666745S1	1 1/4" F	x 4	3/4" M	2	12
666755S1	1 1/4" F	x 5	3/4" M	2	12
666765S1	1 1/4" F	x 6	3/4" M	2	–
666775S1	1 1/4" F	x 7	3/4" M	2	–
666785S1	1 1/4" F	x 8	3/4" M	2	–

667...S1

tech. broch. 01144

Flow manifold, with built-in flow meters and flow rate balancing valves.

Max. working pressure: 10 bar.
Temperature range: 0–80°C.
Outlet centre distance: 50 mm.



Code	Connections	Outlet No.	Outlets		
667735S1	1 1/4" F	x 3	3/4" M	2	12
667745S1	1 1/4" F	x 4	3/4" M	2	12
667755S1	1 1/4" F	x 5	3/4" M	2	12
667765S1	1 1/4" F	x 6	3/4" M	2	–
667775S1	1 1/4" F	x 7	3/4" M	2	–
667785S1	1 1/4" F	x 8	3/4" M	2	–

668...S1

tech. broch. 01144

Pair of manifolds, with built-in flow meters and flow rate balancing valves and shut-off valves.

Max. working pressure: 10 bar.
Temperature range: 0–80°C.
Outlet centre distance: 50 mm.



Code	Connections	Outlet No.	Outlets		
668735S1	1 1/4" F	x 3	3/4" M	1	6
668745S1	1 1/4" F	x 4	3/4" M	1	6
668755S1	1 1/4" F	x 5	3/4" M	1	5
668765S1	1 1/4" F	x 6	3/4" M	1	3
668775S1	1 1/4" F	x 7	3/4" M	1	3
668785S1	1 1/4" F	x 8	3/4" M	1	3

ACCESSORIES FOR DISTRIBUTION MANIFOLDS



668...S1 tech. broch. 01144
 Off-centre by-pass kit with fixed setting 25 kPa (2.500 mm w.g.), complete with pipe for manifold connection. For manifolds 668...S1 series.
 Max. working pressure: 10 bar.
 Temperature range: 0–100°C.

Code			
668000S1	1" nut x 3/4" nut	1	10



5996 tech. broch. 01144
 Flow end fitting complete with double radial end fitting with two-position ball valve, automatic air vent and fill/drain hose connection.
 Max. working pressure: 10 bar.
 Max. discharge pressure: 2,5 bar.
 Temperature range: 0–100°C.

Code			
599674	1 1/4"	1	10



391...S1 tech. broch. 01144
 Pair of ball shut-off valves. Female - male connections with union with O-Ring seal.
 With temperature gauge, scale 0–80°C, Ø 40 mm.
 Max. working pressure: 10 bar.
 Temperature range: 0–100°C.

Code			
391167S1	1" x 1 1/4"	1	
391177S1	1 1/4" x 1 1/4"	1	5
			5



5996 tech. broch. 01144
 Return end fitting complete with double radial end fitting with three-position ball valve, by-pass connection with plug and fill/drain hose connection.
 Max. working pressure: 10 bar.
 Temperature range: 0–100°C.

Code			
599675	1 1/4"	1	10



391...S1 tech. broch. 01144
 Pair of ball shut-off valves. Female - male connections with union with O-Ring seal.
 With temperature gauge connection.
 Max. working pressure: 10 bar.
 Temperature range: 0–100°C.

Code			
391067S1	1" x 1 1/4"	1	–
391077S1	1 1/4" x 1 1/4"	1	–



347...S1 tech. broch. 01144
 Compression fitting for annealed copper, hard copper, brass, mild steel and stainless steel pipes. With O-Ring seal. Specific to be used with manifolds 668...S1 series.
 Max. working pressure: 10 bar.
 Temperature range: -25–120°C.

Code			
347512S1	3/4" - Ø 12	1	50
347514S1	3/4" - Ø 14	1	50



5020 tech. broch. 01144
 Automatic air vent with hygroscopic cap. In hot-stamped brass. For manifolds end fittings 668...S1 series.
 Max. working pressure: 10 bar.
 Max. discharge pressure: 2,5 bar.
 Max. working temperature: 110°C.

Code			
502043	1/2" M	10	100



3642..S1 tech. broch. 01144
 Reduction fitting.

Code			
364276S1	1" F x 1 1/4" M	2	10



658 tech. broch. 01144
 Pair of brackets for use with boxes, 659 and 661 series or directly on the wall. With screws and plugs.

Code			
658100		1	20

DISTRIBUTION MANIFOLDS FOR RADIANT PANEL SYSTEMS

664



tech. broch. 01260

Pre-assembled distribution manifold.
 Max. working pressure: 6 bar.
 Temperature range: 5–60°C.
 Outlet centre distance: 50 mm.

Equipped with:

- return manifold with built-in shut-off valves fitted for thermo-electric actuator;
- flow manifold complete with flow meters with 0–5 l/m scale and flow rate balancing valves;
- end fittings with automatic air vent and drain cock;
- steel mounting brackets for use with box or for direct wall mounting.



Code	Connections	Outlet No.	Outlets		
6646B1	1" x 2	3/4" M	1	–	
6646C1	1" x 3	3/4" M	1	–	
6646D1	1" x 4	3/4" M	1	–	
6646E1	1" x 5	3/4" M	1	–	
6646F1	1" x 6	3/4" M	1	–	
6646G1	1" x 7	3/4" M	1	–	
6646H1	1" x 8	3/4" M	1	–	
6646I1	1" x 9	3/4" M	1	–	
6646L1	1" x 10	3/4" M	1	–	
6646M1	1" x 11	3/4" M	1	–	
6646N1	1" x 12	3/4" M	1	–	
6646O1	1" x 13	3/4" M	1	–	



662

Pre-assembled distribution manifold.
 Max. working pressure: 10 bar.
 Temperature range: 5–80°C.
 Outlet centre distance: 50 mm.

Equipped with:

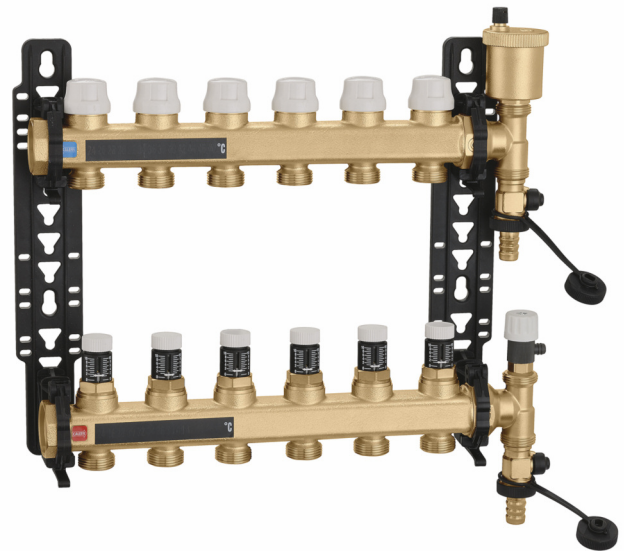
- return manifold with built-in shut-off valves fitted for thermo-electric actuator;
- flow manifold with micrometric preregulating valves;
- end fittings with automatic air vent and drain cock;
- polymer mounting brackets with adjustable centre distance for use with box 659 series or for direct wall mounting.



Code	Connections	Outlet No.	Outlets		
6626B6	1" x 2	3/4" M	1	–	
6626C6	1" x 3	3/4" M	1	–	
6626D6	1" x 4	3/4" M	1	–	
6626E6	1" x 5	3/4" M	1	–	
6626F6	1" x 6	3/4" M	1	–	
6626G6	1" x 7	3/4" M	1	–	
6626H6	1" x 8	3/4" M	1	–	
6626I6	1" x 9	3/4" M	1	–	
6626L6	1" x 10	3/4" M	1	–	
6626M6	1" x 11	3/4" M	1	–	
6626N6	1" x 12	3/4" M	1	–	
6626O6	1" x 13	3/4" M	1	–	

DYNAMIC DISTRIBUTION MANIFOLDS FOR RADIANT PANEL SYSTEMS

NEW

665

DYNAMICAL®

Pre-assembled distribution manifold.
 Max. working pressure: 6 bar.
 Temperature range: 5–60°C.
 Outlet centre distance: 50 mm.

Equipped with:

- return manifold complete with flow adjustment valves DYNAMICAL® fitted for thermo-electric actuator, with flow rate adjustment 25–170 l/h and shut-off valves;
- flow manifold complete with flow indicators;
- end fittings with automatic air vent with hygroscopic cap and drain cock;
- steel mounting brackets for use with box or for direct wall mounting.

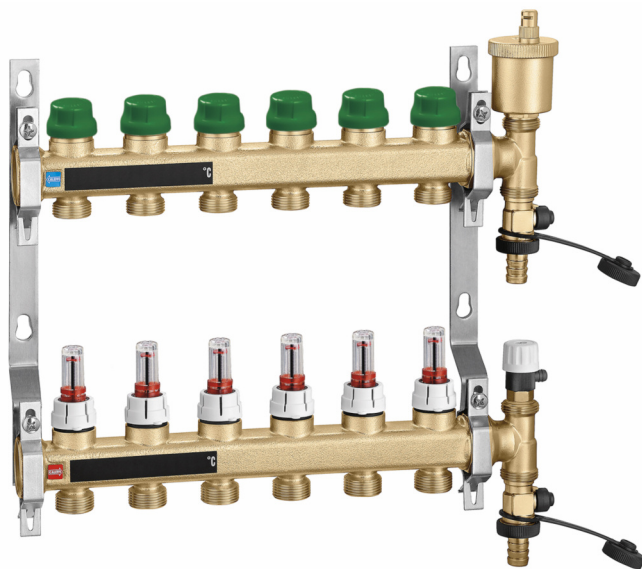

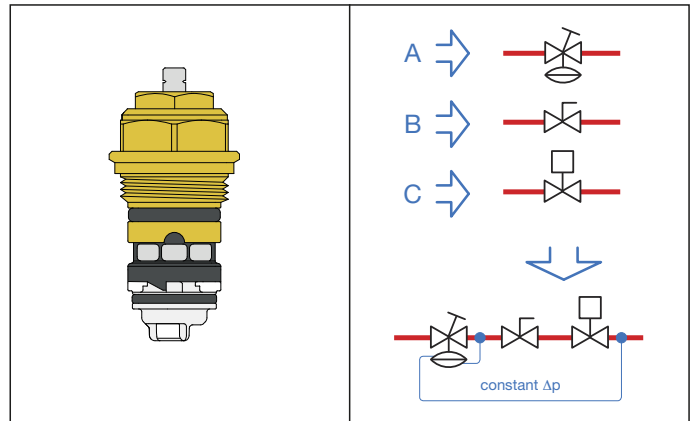

Function

The DYNAMICAL® distribution manifold allows automatic dynamic balancing and a regulation of the thermal medium independent from the pressure in the individual circuits of underfloor heating systems. The device, in conjunction with a thermo-electric control head, combines different functions in a single component.



- A. **The differential pressure regulator** automatically cancels the effect of pressure fluctuation characterising variable flow rate systems and prevents noisy functioning.
- B. **The flow rate pre-setting device** makes it possible to directly set the maximum flow rate value, thanks to the combination with the differential pressure regulator.
- C. **Flow rate adjustment ON/OFF according to the room temperature**, thanks to the combination with a thermo-electric control head. The flow rate adjustment is optimised because it is made pressure independent.

Code	Connections	Outlet No.	Outlets		
6656D1	1"	x 4	3/4" M	1	-
6656E1	1"	x 5	3/4" M	1	-
6656F1	1"	x 6	3/4" M	1	-
6656G1	1"	x 7	3/4" M	1	-
6656H1	1"	x 8	3/4" M	1	-
6656I1	1"	x 9	3/4" M	1	-
6656L1	1"	x 10	3/4" M	1	-
6656M1	1"	x 11	3/4" M	1	-
6656N1	1"	x 12	3/4" M	1	-

ACCESSORIES FOR DISTRIBUTION MANIFOLDS

Insulation for distribution manifolds
6626.5, 664 and 665 series.
For heating and cooling systems.
For use with box code 659..4
(adjustable depth from 110 to 140 mm).



Code			
CBN6646F1	for manifolds from 2 to 6 outlets	1	-
CBN6646N1	for manifolds from 7 to 12 outlets	1	-
CBN6646O1	for manifolds with 13 outlets	1	-

391

Pair of ball shut-off valves with O-Ring seal.
For distribution manifolds 664 and 665 series.
Female - male connections with union
with O-Ring seal.

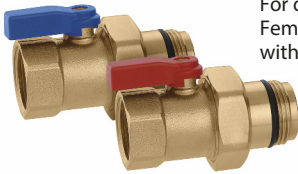

Max. working pressure: 10 bar.
Temperature range: 5-100°C.

Code			
391066	1"	1	-

662

Off-centre by-pass kit
with fixed setting 25 kPa (2.500 mm w.g.).
For distribution manifolds 664 and 665 series.
Max. working pressure: 10 bar.
Temperature range: -10-110°C.



Code			
662010		1	10

680

tech. broch. 01144

DARCAL

Self-adjustable diameter fitting
for single and multilayer plastic pipes.
Max. working pressure: 10 bar.
Temperature range:
5-80°C (PE-X)
5-75°C (Multilayer marked 95°C).



Code		\varnothing_{inside}	$\varnothing_{outside}$		
680507	3/4"	7,5- 8	10,5-12	10	100
680502	3/4"	7,5- 8	12 -14	10	100
680503	3/4"	8,5- 9	12 -14	10	100
680500	3/4"	9 - 9,5	14 -16	10	100
680501	3/4"	9,5-10	12 -14	10	100
680506	3/4"	9,5-10	14 -16	10	100
680515	3/4"	10,5-11	14 -16	10	100
680517	3/4"	10,5-11	16 -18	10	100
680524	3/4"	11,5-12	14 -16	10	100
680526	3/4"	11,5-12	16 -18	10	100
680535	3/4"	12,5-13	16 -18	10	100
680537	3/4"	12,5-13	18 -20	10	100
680544	3/4"	13,5-14	16 -18	10	100
680546	3/4"	13,5-14	18 -20	10	100
680555	3/4"	14,5-15	18 -20	10	100
680556	3/4"	15 -15,5	18 -20	10	100
680564	3/4"	15,5-16	18 -20	10	100
680505	3/4"	17	22,5	10	100

386

tech. broch. 01144

Screw plug with nut,
for manifold outlets.



Code			
386500	3/4"	10	-

675

tech. broch. 01144

Push-fit thermometer for panel piping.
For pipes with outer diameter
from 15 to 18 mm.
Thermometer scale: 5-50°C.
Thermometer fluid: alcohol.
Thermo-conductive paste
supplied in package.



Code			
675900		10	100



DIFFERENTIAL PRESSURE REGULATING VALVE FOR DISTRIBUTION MANIFOLDS

NEW

140

Differential pressure regulating valve for 1" distribution manifolds 671, 662 and 664 series.
 Complete with capillary pipe and metering device for connection.
 Max. working pressure: 16 bar.
 Temperature range: -10-120°C.
 Max. percentage of glycol: 50%.
 Length of capillary pipe Ø 3 mm: 1,5 m.



Code	Differential pressure adjustable set (mbar)			
140300	1"	50-300	1	-

Connection of differential pressure regulating valve 140 series with distribution manifold 671 series

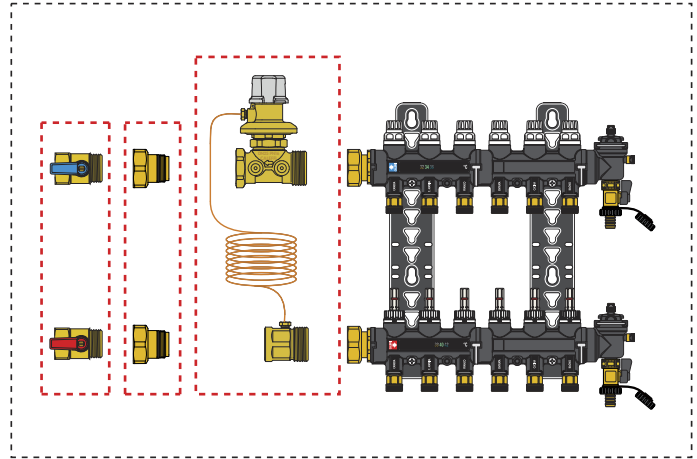

Connection of differential pressure regulating valve 140 series with distribution manifold 662 series

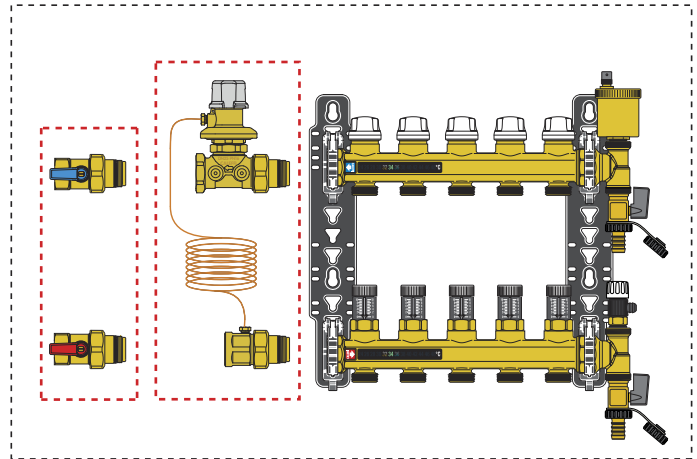

Connection of differential pressure regulating valve 140 series with distribution manifold 664 series

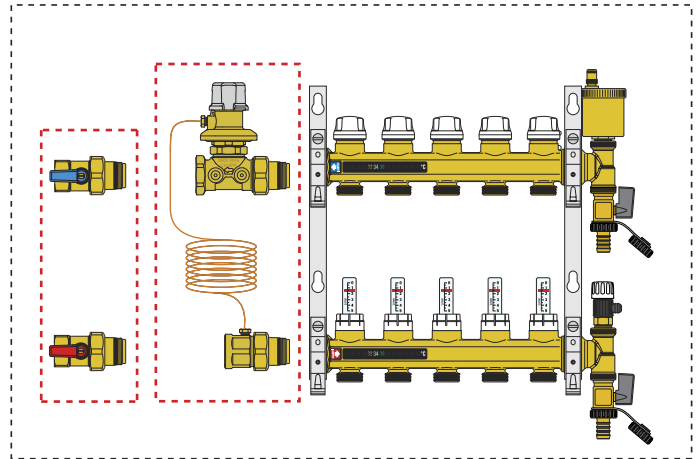

Operating principle

The regulator Δp , fitted at the inlet of the distribution manifold for a radiant panel system, allows the distribution system to operate in constant load conditions even when the system conditions change.

The differential pressure regulating valve acts proportionally to re-establish the preselected Δp conditions on the valve itself while the flow rate is varied by shut-off devices.

The flow pressure value is brought to the top surface of the membrane by means of the connecting capillary tube; the return pressure value is brought to the bottom surface of the membrane through the connecting passage inside the control stem. The force generated by the pressure differential on the membrane exerts a thrust on the obturator stem, closing the passage of medium on the return of the circuit zone until the thrust force of the membrane and the counter-thrust force of the counter-spring reach equilibrium on the set Δp value. This is the pressure differential value that is kept constant between flow and return of the circuit zone.

The regulator action allows the flow rate regulation valves, fitted to the flow manifold, to operate in constant load conditions; this means they can keep the flow rate at a constant level even when the operating conditions for the rest of the system change.

BOXES FOR DISTRIBUTION MANIFOLDS



659

tech. broch. 01144

Inspection wall box for distribution manifolds 349, 350, 592, 662, 663, 668...S1, 671, 664 and 665 series.

Wall or floor installation (with 660 series). Closure with a push-fit clamp. In painted sheet steel.

Adjustable depth from 110 to 140 mm.

Code	(h x w x d)		
659044	500 x 400 x 110-140	1	-
659064	500 x 600 x 110-140	1	-
659084	500 x 800 x 110-140	1	-
659104	500 x 1000 x 110-140	1	-
659124	500 x 1200 x 110-140	1	-



661

tech. broch. 01144

Box for manifolds 662, 671, 668...S1, 664 and 665 series and regulating units 182 series.

With supports for installation on floor. Closure with a push-fit clamp. In painted sheet steel.

Adjustable depth from 110 to 150 mm. Adjustable height from 270 to 410 mm.

Code	(h x w x d)		
661045	500 x 400 x 110-150	1	-
661065	500 x 600 x 110-150	1	-
661085	500 x 800 x 110-150	1	-
661105	500 x 1000 x 110-150	1	-
661125	500 x 1200 x 110-150	1	-



660

tech. broch. 01144

Floor installation kit for box 659 series.

- Consisting of:
- 2 supports height cm. 20,
 - 2 side panels,
 - 1 pipe-bending bar.

Code			
660040	for 659044	1	-
660060	for 659064	1	-
660080	for 659084	1	-
660100	for 659104	1	-
660120	for 659124	1	-



675

Box with adjustable depth and height. **Equipped with mounting brackets for manifolds 671 series.**

Closure with a push-fit clamp. Adjustable depth: 80 to 120 mm. Adjustable height: 235 to 325 mm.

Code	Dim. (h x w x d)		
675060	550 x 600 x 80-120	1	-
675080	550 x 800 x 80-120	1	-



659

tech. broch. 01144

Inspection wall box for distribution manifolds 349, 350, 592, 662, 671, 664 and 665 series. Complete with specific support for manifold brackets.

Closure with a push-fit clamp. In painted sheet steel.

Adjustable depth from 80 to 120 mm.

Code	(h x w x d)		
659045	500 x 400 x 80-120	1	-
659065	500 x 600 x 80-120	1	-
659085	500 x 800 x 80-120	1	-
659105	500 x 1000 x 80-120	1	-

THERMO-ELECTRIC ACTUATORS

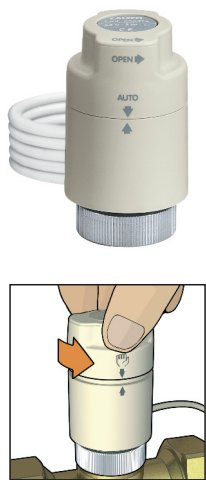

6563

tech. broch. 01142

Thermo-electric actuator. With manual opening and position indicator. For distribution manifolds 670, 671, 668...S1, 6626.6, 664 and 665 series. Normally closed. **With auxiliary microswitch.** Supply: 230 V (ac) or 24 V (ac)/(dc). Power consumption: 3 W. Starting current: ≤ 1 A. Starting current (656344/54): ≤ 250 mA. Auxiliary microswitch contact rating: 0,8 A (230 V). Ambient temperature range: 0–50°C. Protection class: IP 40. Cable length: 80 cm.



Code	Supply voltage V			
656312	230		1	10
656314	24		1	10
656302	230	without auxiliary microswitch	1	10
656304	24	without auxiliary microswitch	1	10

With low power consumption

Code	Supply voltage V			
656354	24		1	10
656344	24	without auxiliary microswitch	1	10



6561

tech. broch. 01042

Thermo-electric actuator. For distribution manifolds 670, 671, 668...S1, 6626.6, 664 and 665 series. Normally closed. **With auxiliary microswitch.** Supply: 230 V (ac) or 24 V (ac)/(dc). Auxiliary microswitch contact rating: 0,8 A (230 V). Power consumption: 3 W. Starting current: ≤ 1 A. Max. ambient temperature: 50°C. Protection class: IP 44 (vertical stem). Cable length: 80 cm.



Code	Supply voltage V			
656112	230		1	10
656114	24		1	10
656102	230	without auxiliary microswitch	1	10
656104	24	without auxiliary microswitch	1	10



6562

tech. broch. 01198

Thermo-electric actuator. With opening position indicator. **Quick-coupling installation, with a clip adapter.** For distribution manifolds 670, 671, 668...S1, 6626.6, 664 and 665 series. Normally closed. **With auxiliary microswitch.** Supply: 230 V (ac) or 24 V (ac)/(dc). Auxiliary microswitch contact rating: 0,8 A (230 V). Power consumption: 3 W. Starting current: ≤ 1 A. Ambient temperature range: 0–50°C. Protection class: IP 54. Cable length: 80 cm.

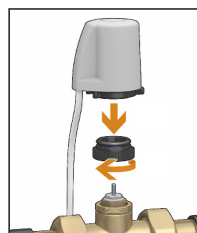

Code	Supply voltage V			
656212	230		1	10
656214	24		1	10
656202	230	without auxiliary microswitch	1	10
656204	24	without auxiliary microswitch	1	10

6564

tech. broch. 01198

Thermo-electric actuator with low power consumption. With opening position indicator. **Quick-coupling installation, with a clip adapter.** For distribution manifolds 670, 671, 668...S1, 6626.6, 664 and 665 series. Normally closed. **With auxiliary microswitch.** Supply: 230 V (ac) or 24 V (ac)/(dc). Auxiliary microswitch contact rating: 0,8 A (230 V). Power consumption: 3 W. Starting current: ≤ 250 mA. Ambient temperature range: 0–50°C. Protection class: IP 54. Cable length: 80 cm.



Code	Supply voltage V			
656412	230		1	10
656414	24		1	10
656402	230	without auxiliary microswitch	1	10
656404	24	without auxiliary microswitch	1	10



6205

tech. broch. 01186

Control bar. Supply: 230 V - 50/60 Hz. Power consumption: 5,5 VA max (8 outputs). Changeover contacts: 10 A. Protection class: IP 30 (with rubber cable clamps). Output command for pump. Input for SUMMER - WINTER. Input for timer.



Code			
620542	4 canali	1	-
620582	8 canali	1	-

COMPONENTS FOR DOMESTIC WATER SYSTEMS

This diagram is just an indication

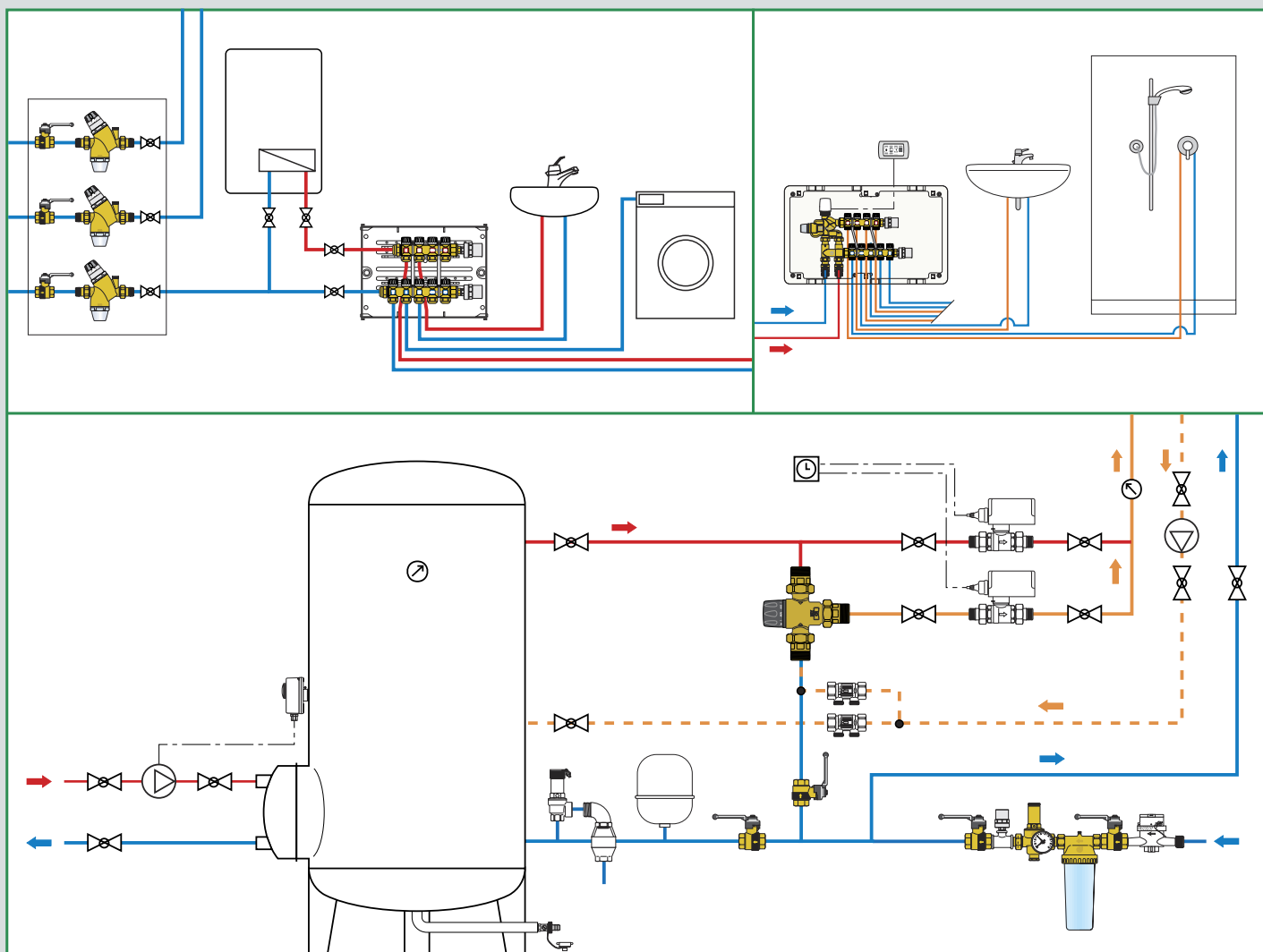

6

Pressure reducing valves

Pressure reducing and stabilising valves

Anti-pollution check valves with built-in shut-off valve

Ball valves with built-in check valve, BALLSTOP - Single and double check valves

Thermostatic mixing valves - Tempering valves - Control unit for domestic hot water temperature

Hybrid electronic mixing valve, LEGIOMIX® 2.0

Electronic mixing valve with programmable thermal disinfection, LEGIOMIX® - Anti-scald device

Unit for temperature control and thermal disinfection, LEGIOFLOW® - Timer for valve operation

Multi-function thermostatic regulator

Strainers cartridges and housing - Water hammer arresters, ANTISHOCK

Safety groups - Temperature and pressure relief valve - Flow limiter

Expansion groups - Hydraulic safety groups for hot water storage heaters

Pre-assembled domestic water distribution manifolds

Anti-freeze safety device



Domestic Water Sizer



DOMESTIC WATER SYSTEM SIZER ALSO FOR SMARTPHONE

Available on www.caleffi.com and app for smartphone.

Download the version for your iOS and Android® mobile phone.

INCLINED MICRO PRESSURE REDUCING VALVE FOR SPECIAL APPLICATIONS

NEW



533...H

tech. broch. 01332

Inclined micro pressure reducing valve for special applications: **for dispensing water, beverages and coffee machines.**

Replaceable cartridge and strainer.
dezincification resistant alloy body
"LOW LEAD".

Max. upstream pressure: 16 bar.
Downstream setting pressure range: 0,8–4 bar.
Max. working temperature: 80°C.
Max. recommended flow rate: 6 l/min.

Certified to EN 1567.
PATENT PENDING.



Code	DN			
533430H	8 3/8"		1	20
533230H	8 3/8"	with pressure gauge 0–10 bar	1	20

Code			
F0002665	pressure gauge 0–10 bar	1	–

Applications

The 533...H series of micro pressure reducing valves has been specially created for applications where it is necessary to reduce and precisely stabilise the pressure arriving from the mains in the presence of low flow rate values. The 533...H series is typically installed for service in appliances that also have important dimensions and intermittent operation. The performance of this series of micro pressure reducing valves complies with the requirements of standard EN 1567, for use with cold water and hot water up to 80°C.

The typical applications of these micro pressure reducing valves are appliances for dispensing water, beverages and coffee machines.

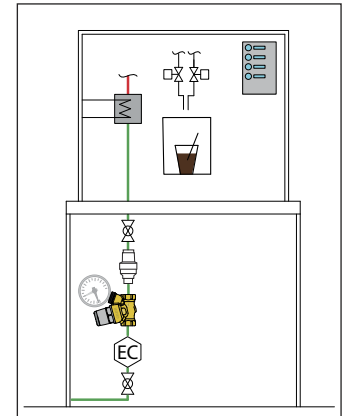
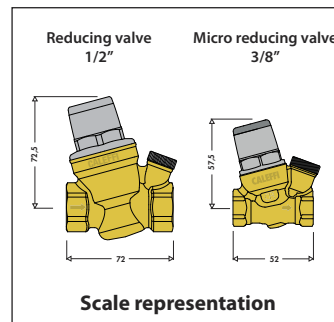

INCLINED PRESSURE REDUCING VALVES



5330

tech. broch. 01024

Inclined pressure reducing valve.
Replaceable cartridge and strainer.
Brass body. Chrome plated.
Max. upstream pressure: 16 bar.
Downstream setting pressure range: 1–6 bar.
Max. working temperature: 40°C.



Code			
533041	1/2"	1	20
533051	3/4"	1	20



5332

tech. broch. 01024

Inclined pressure reducing valve.
Replaceable cartridge and strainer.
Brass body. Chrome plated.
Max. upstream pressure: 16 bar.
Downstream setting pressure range: 1–6 bar.
Max. working temperature: 40°C.
With pressure gauge: 0–10 bar.



Code			
533241	1/2"	1	20
533251	3/4"	1	20



5331

tech. broch. 01024

Inclined pressure reducing valve for safety group.
Replaceable cartridge and strainer.
Brass body. Chrome plated.
Max. upstream pressure: 16 bar.
Downstream setting pressure range: 1–6 bar.
Max. working temperature: 40°C.



Code			
533151	3/4" M x nut 3/4" F	1	25



5334

tech. broch. 01024

Inclined pressure reducing valve.
Replaceable cartridge and strainer.
Brass body. Chrome plated.
Max. upstream pressure: 16 bar.
Downstream setting pressure range: 1–6 bar.
Max. working temperature: 40°C.
With 1/4" F pressure gauge connection.



Code			
533441	1/2"	1	20
533451	3/4"	1	20
533461	1"	1	25

INCLINED PRESSURE REDUCING VALVES



5336

tech. broch. 01024

Inclined pressure reducing valve with compression ends. Replaceable cartridge and strainer. **CR** dezincification resistant alloy body. Chrome plated. Max. upstream pressure: 16 bar. Downstream setting pressure range: 1–6 bar. Max. working temperature: 40°C.



Code			
533641	Ø 15	1	25
533651	Ø 22	1	25



5335



Inclined pressure reducing valve. Replaceable cartridge and strainer. **CR** dezincification resistant alloy body. Max. upstream pressure: 1600 kPa. Downstream setting pressure range: 100–600 kPa. Max. working temperature: 40°C. With 1/4" F pressure gauge connection.



Code			
533545 AUS	1/2"	1	25
533555 AUS	3/4"	1	25



5337

tech. broch. 01024

Inclined pressure reducing valve with compression ends. Replaceable cartridge and strainer. **CR** dezincification resistant alloy body. Chrome plated. Max. upstream pressure: 16 bar. Downstream setting pressure range: 1–6 bar. Max. working temperature: 40°C. With 1/4" F pressure gauge connection.



Code			
533741	Ø 15	1	20
533751	Ø 22	1	20



5335



Three-way inclined pressure reducing valve. Replaceable cartridge and strainer. **CR** dezincification resistant alloy body. Interchangeable outlet, with plug. Max. upstream pressure: 1600 kPa. Downstream setting pressure range: 100–600 kPa. Max. working temperature: 40°C.



Code			
533550 AUS	3/4"	1	30



5338

tech. broch. 01024

Inclined pressure reducing valve with compression ends. Replaceable cartridge and strainer. **CR** dezincification resistant alloy body. Chrome plated. Max. upstream pressure: 16 bar. Downstream setting pressure range: 1–6 bar. Max. working temperature: 40°C. With pressure gauge: 0–10 bar.



Code			
533841	Ø 15	1	20
533851	Ø 22	1	20



5339



Inclined pressure reducing valve with compression ends and built-in safety relief valve. Pressure reducing valve. **CR** dezincification resistant alloy body. Replaceable cartridge and strainer. Max. upstream pressure: 1600 kPa. Downstream setting pressure range: 100–600 kPa. Max. working temperature: 40°C. Safety relief valve. With stainless steel seat. **CR** dezincification resistant alloy body.



Code			
533944	Ø 15	1	25
533954	Ø 22	1	25



5330

Spare cartridge. For inclined pressure reducing valves 5330, 5331, 5332, 5334, 5335, 5336, 5337, 5338 and 5339 series.

Code			
533000		1	100

INCLINED PRESSURE REDUCING VALVES FOR HIGH TEMPERATURE



5330..H [tech. broch. 01252](#)

Inclined pressure reducing valve.
For high temperature.
Replaceable cartridge and strainer.
Brass body. Chrome plated.
Max. upstream pressure: 16 bar.
Downstream setting pressure range: 1–5,5 bar.
Max. working temperature: 80°C.
Certified to EN 1567.



Code			
533041H	1/2"	1	20
533051H	3/4"	1	20



5331..H [tech. broch. 01252](#)

Inclined pressure reducing valve
for safety group.
For high temperature.
Replaceable cartridge and strainer.
CR dezincification resistant alloy body.
Max. upstream pressure: 16 bar.
Downstream setting pressure range: 1–5,5 bar.
Max. working temperature: 80°C.
Certified to EN 1567.



Code			
533159H	Ø 22 x nut 3/4" F	1	30



5332..H [tech. broch. 01252](#)

Inclined pressure reducing valve.
For high temperature.
Replaceable cartridge and strainer.
Brass body. Chrome plated.
Max. upstream pressure: 16 bar.
Downstream setting pressure range: 1–5,5 bar.
Max. working temperature: 80°C.
With pressure gauge: 0–10 bar.
Certified to EN 1567.



Code			
533241H	1/2"	1	20
533251H	3/4"	1	20



5332..H [tech. broch. 01252](#)

Inclined pressure reducing valve.
For high temperature.
Replaceable cartridge and strainer.
CR dezincification resistant alloy body.
Chrome plated.
Max. upstream pressure: 16 bar.
Downstream setting pressure range: 1–5,5 bar.
Max. working temperature: 80°C.
With pressure gauge: 0–10 bar.
Certified to EN 1567.



Code			
533241H LTC	1/2"	1	20
533251H LTC	3/4"	1	20



5334..H [tech. broch. 01252](#)

Inclined pressure reducing valve.
For high temperature.
Replaceable cartridge and strainer.
Brass body. Chrome plated.
Max. upstream pressure: 16 bar.
Downstream setting pressure range: 1–5,5 bar.
Max. working temperature: 80°C.
With 1/4" F pressure gauge connection.
Certified to EN 1567.



Code			
533441H	1/2"	1	20
533451H	3/4"	1	20
533461H	1"	1	25



5334..H [tech. broch. 01252](#)

Inclined pressure reducing valve.
For high temperature.
Replaceable cartridge and strainer.
CR dezincification resistant alloy body.
Chrome plated.
Max. upstream pressure: 16 bar.
Downstream setting pressure range: 1–5,5 bar.
Max. working temperature: 80°C.
With 1/4" F pressure gauge connection.
Certified to EN 1567.



Code			
533441H LTC	1/2"	1	20
533451H LTC	3/4"	1	20
533461H LTC	1"	1	20

INCLINED PRESSURE REDUCING VALVES FOR HIGH TEMPERATURE



5336..H tech. broch. 01252

Inclined pressure reducing valve with compression ends. For high temperature. Replaceable cartridge and strainer. **CR** dezincification resistant alloy body. Chrome plated. Max. upstream pressure: 16 bar. Downstream setting pressure range: 1–5,5 bar. Max. working temperature: 80°C. **Certified to EN 1567.**



Code			
533641H	Ø 15	1	25
533651H	Ø 22	1	25



5335..H

Inclined pressure reducing valve. Replaceable cartridge and strainer. **CR** dezincification resistant alloy body. Max. inlet pressure: 2000 kPa. Downstream setting pressure range: 100–600 kPa. Max. working temperature: 80°C. With 1/4" F pressure gauge connection.



Code			
533545H AUS	1/2"	1	25
533555H AUS	3/4"	1	25
533565H AUS	1"	1	10



5337..H tech. broch. 01252

Inclined pressure reducing valve with compression ends. For high temperature. Replaceable cartridge and strainer. **CR** dezincification resistant alloy body. Chrome plated. Max. upstream pressure: 16 bar. Downstream setting pressure range: 1–5,5 bar. Max. working temperature: 80°C. With 1/4" F pressure gauge connection. **Certified to EN 1567.**



Code			
533741H	Ø 15	1	20
533751H	Ø 22	1	20
533761H	Ø 28	1	20



5335..H

Three-way inclined pressure reducing valve. Replaceable cartridge and strainer. **CR** dezincification resistant alloy body. Interchangeable outlet, with plug. Max. inlet pressure: 2000 kPa. Downstream setting pressure range: 100–600 kPa. Max. working temperature: 80°C.



Code			
533550H AUS	3/4"	1	30



5338..H tech. broch. 01252

Inclined pressure reducing valve with compression ends. For high temperature. Replaceable cartridge and strainer. **CR** dezincification resistant alloy body. Chrome plated. Max. upstream pressure: 16 bar. Downstream setting pressure range: 1–5,5 bar. Max. working temperature: 80°C. With pressure gauge: 0–10 bar. **Certified to EN 1567.**



Code			
533841H	Ø 15	1	20
533851H	Ø 22	1	20
533861H	Ø 28	1	20



5335..H

Two-way inclined pressure reducing valve. Replaceable cartridge and strainer. **CR** dezincification resistant alloy body. Interchangeable outlet, with plug. Max. inlet pressure: 2000 kPa. Downstream setting pressure: 500 kPa. Max. working temperature: 80°C.



Code			
533551H AUS	3/4"	1	30



5330..H

Spare cartridge. For inclined pressure reducing valves 5330H, 5331H, 5332H, 5334H, 5335H, 5336H, 5337H, 5338H and 5339H series.

Code			
53300H		1	100

PRE-ADJUSTABLE PRESSURE REDUCING VALVES

5350



Pressure reducing valve with self-contained replaceable cartridge. CR dezincification resistant alloy body. With pressure regulating scale for manual pressure adjustment. Male union connections. Max. upstream pressure: 25 bar. Downstream setting pressure range: 1–6 bar. Max. working temperature: 40°C. Certified to EN 1567.



With pressure gauge 0–10 bar

Code			
535041	1/2"	1	5
535051	3/4"	1	5
535061	1"	1	5
535075*	1 1/4" with 1" reduced cartridge	1	5
535071	1 1/4"	1	4
535081	1 1/2"	1	4
535091	2"	1	4

* Without DVGW certification

With 1/4" F pressure gauge connection

Code			
535040	1/2"	1	5
535050	3/4"	1	5
535060	1"	1	5
535074*	1 1/4" with 1" reduced cartridge	1	5
535070	1 1/4"	1	4
535080	1 1/2"	1	4
535090	2"	1	4

* Without DVGW certification

5350



Pressure reducing valve with self-contained replaceable cartridge. CR dezincification resistant alloy body. With pressure regulating scale for manual pressure adjustment. Ø 22 mm with compression ends. Max. upstream pressure: 25 bar. Downstream setting pressure range: 1–6 bar. Max. working temperature: 40°C.



With 1/4" F pressure gauge connection

Code			
535022	Ø 22	1	10

5351



Pressure reducing valve with self-contained replaceable cartridge. Brass body. With pressure regulating scale for manual pressure adjustment. Stainless steel strainer cartridge with transparent housing. Male union connections. Max. upstream pressure: 25 bar. Downstream setting pressure range: 1–6 bar. Max. working temperature: 40°C. Strainer mesh size Ø: 0,28 mm. Certified to EN 1567.



With replacement strainer and key to service strainer and cartridge.

With stainless steel pressure gauge 0–10 bar

Code			
535141	1/2"	1	5
535151	3/4"	1	5
535161	1"	1	5

With 1/4" F pressure gauge connection

Code			
535140	1/2"	1	5
535150	3/4"	1	5
535160	1"	1	5

5350

Spare cartridge and key to service strainer and cartridge. For pressure reducing valves 5350 and 5351 series.



Code			
535004	1/2" - 3/4"	1	8
535006	1"	1	8
535017	1 1/4" (535074 - 535075)	1	–
535007	1 1/4" - 1 1/2" - 2"	1	–
R52484	key to service strainer and cartridge	1	–

PRE-ADJUSTABLE PRESSURE REDUCING VALVES FOR HIGH TEMPERATURE



5350..H

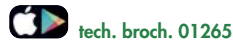

Pressure reducing valve with self-contained replaceable cartridge. For high temperature. CR dezincification resistant alloy body "LOW LEAD". With pressure regulating scale for manual pressure adjustment. Male union connections.

Max. inlet pressure: 25 bar (static - EN 1567).
Max. inlet pressure: 16 bar (working - EN 1567).
Downstream setting pressure range: 1-6 bar.
Max. working temperature: 80°C.
Certified to EN 1567.



With pressure gauge 0-10 bar

Code			
535041H	1/2"	1	5
535051H	3/4"	1	5
535061H	1"	1	5
535071H	1 1/4"	1	4
535081H	1 1/2"	1	4
535091H	2"	1	4

With 1/4" F pressure gauge connection

Code			
535040H	1/2"	1	5
535050H	3/4"	1	5
535060H	1"	1	5
535070H	1 1/4"	1	4
535080H	1 1/2"	1	4
535090H	2"	1	4



5350..H



Pressure reducing valve with self-contained replaceable cartridge. For high temperature. CR dezincification resistant alloy body "LOW LEAD". With pressure regulating scale for manual pressure adjustment.

Compression ends connections.
Max. inlet pressure: 25 bar (static - EN 1567).
Max. inlet pressure: 16 bar (working - EN 1567).
Downstream setting pressure range: 1-6 bar.
Max. working temperature: 80°C.
Certified to EN 1567.



With 1/4" F pressure gauge connection

Code			
535015H	Ø 15	1	5
535022H	Ø 22	1	5
535028H	Ø 28	1	5



5350..H



Pressure reducing valve with self-contained replaceable cartridge. For high temperature. CR dezincification resistant alloy body "LOW LEAD". With pressure regulating scale for manual pressure adjustment. Male union connections.

Max. upstream pressure: 2000 kPa.
Downstream setting pressure range: 100-600 kPa.
Max. working temperature: 80°C.



With pressure gauge 0-10 bar

Code			
535041H AUS	1/2"	1	5
535051H AUS	3/4"	1	5
535061H AUS	1"	1	5
535071H AUS	1 1/4"	1	4
535081H AUS	1 1/2"	1	4
535091H AUS	2"	1	4

With 1/4" F pressure gauge connection

Code			
535040H AUS	1/2"	1	5
535050H AUS	3/4"	1	5
535060H AUS	1"	1	5
535070H AUS	1 1/4"	1	4
535080H AUS	1 1/2"	1	4
535090H AUS	2"	1	4

5350..H

Spare cartridge for pressure reducing valves 5350H series.



Code			
535006H	1/2" - 3/4" - 1"	1	8
535009H	1 1/4" - 1 1/2" - 2"	1	-

PRESSURE REDUCING VALVE

539



Pressure reducing valve. CR dezincification resistant alloy body. Supplied with two female - male fittings. Max. upstream pressure: 25 bar. Downstream setting pressure range: 1-5,5 bar. Factory set: 3 bar. Max. working temperature: 80°C. Certified to EN 1567.



With 1/4" F double pressure gauge connection

Code			
539250	3/4"	1	20

PRESSURE REDUCING VALVES

NEW

5360



Pressure reducing valve for first stage control, with replaceable cartridge.
CR dezincification resistant alloy body.
 Male union connections.
 Max. upstream pressure: 2500 kPa.
 Downstream setting pressure range: 600–1000 kPa.
 Pressure gauge: 0–2500 kPa.
 Max. working temperature: 80°C.



Code

536043 AUS	1/2"	1	5
536053 AUS	3/4"	1	5
536063 AUS	1"	1	5
536073 AUS	1 1/4"	1	4
536073 AUS	1 1/2"	1	4

5365



tech. broch. 01026

Pressure reducing valve with replaceable cartridge.
 Bronze body. Male union connections.
 Max. upstream pressure: 25 bar.
 Downstream setting pressure range: 0,5–6 bar.
 Pressure gauge upstream: 0–25 bar.
 Pressure gauge downstream: 0–10 bar.
 Max. working temperature: 80°C.
Certified to EN 1567.

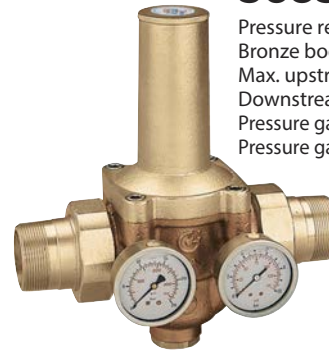

Code

53658.	1 1/2"	1	–
53659.	2"	1	–

- 1 With double pressure gauge in glycerine bath
- 0 With 1/4" F double pressure gauge connection

5360



tech. broch. 01026

Pressure reducing valve with replaceable cartridge.
CR dezincification resistant alloy body.
 Male union connections.
 Max. upstream pressure: 25 bar.
 Downstream setting pressure range: 0,5–6 bar.
 Max. working temperature: 80°C.
Certified to EN 1567.



Code

53604.	1/2"	1	5
53605.	3/4"	1	5
53606.	1"	1	5
53607.	1 1/4"	1	4
53608.	1 1/2"	1	4

- 1 With pressure gauge 0–10 bar
- 0 With 1/4" F pressure gauge connection

5366



tech. broch. 01026

Pressure reducing valve with replaceable cartridge.
 Bronze body. Flanged connections, PN 16.
 To be coupled with flat counterflanges EN 1092-1.
 Max. upstream pressure: 16 bar.
 Downstream setting pressure range: 0,5–6 bar.
With double pressure gauge in glycerine bath.
 Pressure gauge upstream: 0–25 bar.
 Pressure gauge downstream: 0–10 bar.
 Max. working temperature: 80°C.

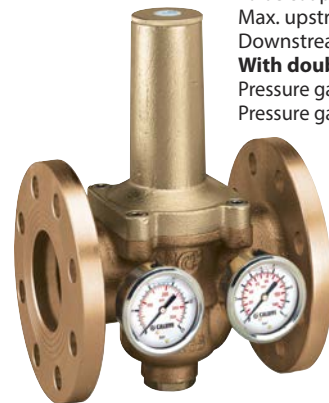

Code

536660	DN 65	1	–
--------	-------	---	---

5362



tech. broch. 01026

Pressure reducing valve with replaceable cartridge.
CR dezincification resistant alloy body.
 Female connections.
 Max. upstream pressure: 25 bar.
 Downstream setting pressure range: 0,5–6 bar.
 Max. working temperature: 80°C.



Code

53624.	1/2"	1	5
53625.	3/4"	1	5
53626.	1"	1	5

- 1 With pressure gauge 0–10 bar
- 0 With 1/4" F pressure gauge connection

5360

Spare cartridge for pressure reducing valves 5360, 5362, 5365 and 5366 series.



Code

536004	1/2"	1	–
536005	3/4" - 1"	1	–
536027	1 1/4" - 1 1/2" (5360)	1	–
536008	1 1/2" (5365) - 2" - DN 65	1	–

537

Soldering union connections.



Code

537015	3/4" x Ø 15	1	–
537022	1" x Ø 22	1	–
537028	1 1/4" x Ø 28	1	–
537035	1 1/2" x Ø 35	1	–

PRESSURE REDUCING AND STABILISING VALVES

576



Pressure reducing valve. Cast iron body, PN 16. Flanged connections PN 16. To be coupled with flat counterflanges EN 1092-1. Max. upstream pressure: 16 bar. Downstream setting pressure range: 2–14 bar. Supplied with double pressure gauge.

For combination with Y-strainer 579 series see page 162.

Available on request PN 25 and PN 40.

Code			
576062	DN 65	1	–
576082	DN 80	1	–
576102	DN 100	1	–
576122	DN 125	1	–
576152	DN 150	1	–

578



Pilot operated pressure reducing valves. Cast iron body, PN 25. Flanged connections. To be coupled with flat counterflanges EN 1092-1: DN 65–DN 150, PN 16; DN 200–DN 300, PN 10. Max. upstream pressure: 25 bar. Downstream setting pressure range: 2,1–21 bar. Supplied with double pressure gauge.

Code			
578062	DN 65	1	–
578082	DN 80	1	–
578102	DN 100	1	–
578122	DN 125	1	–
578152	DN 150	1	–
578202	DN 200	1	–
578252	DN 250	1	–
578302	DN 300	1	–

ANTI-POLLUTION CHECK VALVES WITH BUILT-IN SHUT-OFF VALVE

NEW



324

tech. broch. 01341

Anti-pollution check valve with built-in shut-off valve. **EA type**. Pressure test ports upstream and downstream. Replaceable check valve cartridge. **CR** dezincification resistant alloy body **"LOW LEAD"**. Medium: drinking water. Max. working pressure: 10 bar. Check valve minimum opening pressure (Δp): 0,5 kPa. Max. working temperature: 65°C. **To EN 13959 and EN 13828 standards.** PATENT PENDING.

kiwa

Code	DN internal check valve	Conn.		
324140	20	1/2" M	1	–
324150	20	3/4" M	1	–

NEW



324

tech. broch. 01341

Anti-pollution check valve with built-in shut-off valve. **EA type**. Pressure test ports upstream and downstream. Replaceable check valve cartridge. **CR** dezincification resistant alloy body **"LOW LEAD"**. Medium: drinking water. Max. working pressure: 10 bar. Check valve minimum opening pressure (Δp): 0,5 kPa. Max. working temperature: 65°C. **To EN 13959 and EN 13828 standards.** PATENT PENDING.

kiwa

Code	DN internal check valve	Conn.		
324250	20	3/4" M x nut 3/4" F	1	–

NEW



324

tech. broch. 01341

Anti-pollution check valve with built-in shut-off valve. **EA type**. Pressure test ports upstream and downstream. Replaceable check valve cartridge. **CR** dezincification resistant alloy body **"LOW LEAD"**. Medium: drinking water. Max. working pressure: 10 bar. Check valve minimum opening pressure (Δp): 0,5 kPa. Max. working temperature: 65°C. **To EN 13959 and EN 13828 standards.** PATENT PENDING.

kiwa

Code	DN internal check valve	Conn.		
324110	20	Ø 15	1	–
324120	20	Ø 22	1	–

Code			
F0002665	pressure gauge 0÷10 bar	1	–

For further details see section 7.

BALL VALVE WITH BUILT-IN CHECK VALVE



3230 BALLSTOP

tech. broch. 01021

Ball valve with built-in check valve.
Brass body.
Female connections.
Butterfly handle.
Max. working pressure: 16 bar.
Temperature range: 5–90°C.



Code

323040	1/2"	10	–
323050	3/4"	10	–
323060	1"	4	–



333 BALLSTOP

tech. broch. 01021

Ball valve with built-in check valve.
Brass body.
Female - nut connection.
Drilled tamper-proof safety nut.
Butterfly handle.
Max. working pressure: 16 bar.
Temperature range: 5–90°C.



Code

333400	1/2" F x nut 3/4" F	10	–
333500	3/4" F x nut 3/4" F	10	–



3230 BALLSTOP

tech. broch. 01021

Ball valve with built-in check valve.
Brass body.
Female connections.
Lever handle.
Max. working pressure: 16 bar.
Temperature range: 5–90°C.



Code

323070	1 1/4"	4	–
323080	1 1/2"	2	–
323090	2"	1	–



334 BALLSTOP

tech. broch. 01021

Ball valve with built-in check valve.
Brass body.
Male - nut connection.
Drilled tamper-proof safety nut.
Butterfly handle.
Max. working pressure: 16 bar.
Temperature range: 5–90°C.



Code

334400	1/2" M x nut 3/4" F	10	–
334500	3/4" M x nut 3/4" F	10	–



332 BALLSTOP

tech. broch. 01021

Ball valve with built-in check valve.
Brass body.
Male - female connections.
Butterfly handle.
Max. working pressure: 16 bar.
Temperature range: 5–90°C.



Code

332400	1/2" M x 1/2" F	10	–
--------	-----------------	----	---

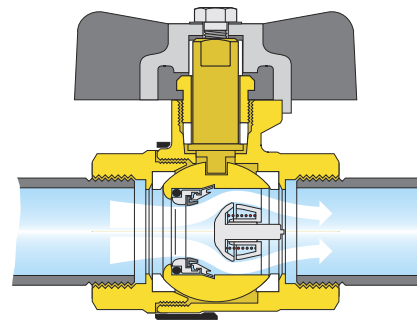

BALLSTOP
TWO VALVES
IN ONE

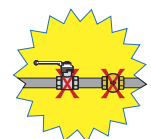

SINGLE AND DOUBLE CHECK VALVES



3037 ROBOCHECK-1

15 mm single check valve with compression ends.
CR dezincification resistant alloy body.
Chrome plated.
Max. working pressure: 10 bar.
Max. working temperature: 90°C.



Code

303715	Ø 15	10	100
--------	------	----	-----



3038 ROBOCHECK-2

15 mm controllable double check valve with compression ends.
CR dezincification resistant alloy body.
Chrome plated.
Max. working pressure: 10 bar.
Max. working temperature: 90°C.



Code

303815	Ø 15	10	100
--------	------	----	-----

THERMOSTATIC MIXING VALVES FOR SMALL APPLICATIONS



520 tech. broch. 01064

Adjustable thermostatic mixing valve. Brass body. Chrome plated. Max. working pressure: 10 bar. Max. inlet temperature: 90°C.



Code	Temperature adjustment	Kv (m³/h)		
520430	1/2" 30-48°C	1,30	1	50
520440	1/2" 40-60°C	1,30	1	50
520530	3/4" 30-48°C	1,80	1	50
520540	3/4" 40-60°C	1,80	1	50
520630	1" 30-48°C	2,75	1	10
520640	1" 40-60°C	2,75	1	10



521 tech. broch. 01050

Adjustable **anti-scale** thermostatic mixing valve with check valves. **CR** dezincification resistant alloy body. Chrome plated. Max. working pressure: 14 bar. Max. inlet temperature: 85°C. **Certified to EN 1287.**



Code	Temperature adjustment	Kv (m³/h)		
521503	3/4" 30-65°C	2,6	1	10



522 tech. broch. 01064

Adjustable thermostatic mixing valve. For hot water storage heaters. Brass body. Chrome plated. Max. working pressure: 10 bar. Max. inlet temperature: 90°C.

Code	Temperature adjustment	Kv (m³/h)		
522430	1/2" 30-48°C	1,30	1	15
522440	1/2" 40-60°C	1,30	1	15



521 tech. broch. 01050

Adjustable **anti-scale** thermostatic mixing valve with check valves, strainers at the inlets and compression ends. **CR** dezincification resistant alloy body. Chrome plated. Max. working pressure: 14 bar. Max. inlet temperature: 85°C. **Certified to EN 1287.**



Code	Temperature adjustment	Kv (m³/h)		
521115	Ø 15 30-65°C	2,6	1	10
521122	Ø 22 30-65°C	2,6	1	10



521 tech. broch. 01050

Adjustable **anti-scale** thermostatic mixing valve. **CR** dezincification resistant alloy body. Chrome plated. Max. working pressure: 14 bar. Max. inlet temperature: 85°C. **Certified to EN 1287.**



Code	Temperature adjustment	Kv (m³/h)		
521400	1/2" 30-65°C	2,6	1	10
521500	3/4" 30-65°C	2,6	1	10

Application diagram of thermostatic mixing valve 521 series

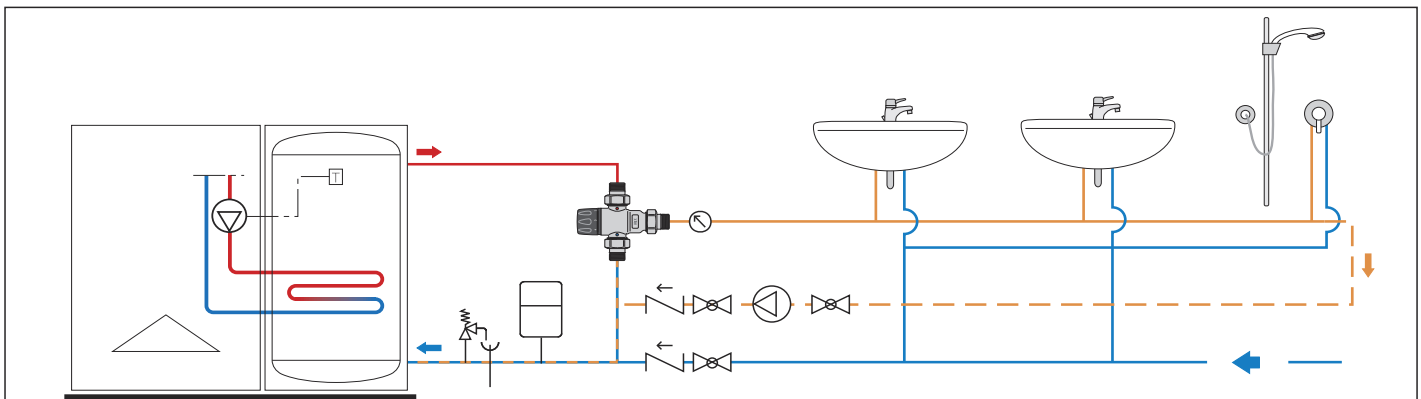

TEMPERING VALVE FOR INSTALLATION AT THE POINT OF DISTRIBUTION

5219



Tempering valve adjustable with knob.
For temperature control at the point of distribution.
With thermal shut-off function.

CR dezincification resistant alloy body.
Chrome plated.
Max. working pressure: 10 bar.
Max. inlet temperature: 90°C.
PATENT.



Code	Temperature adjustment	Kv (m ³ /h)		
521934	1/2"	35-65°C	1,5	1 10
521935	3/4"	35-65°C	1,7	1 10
521936	1"	35-65°C	3,0	1 5

5218

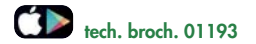

Tempering valve adjustable with knob,
with check valves and strainers.

Specific to control the temperature at the point of distribution.
With thermal shut-off function.
CR dezincification resistant alloy body.
Chrome plated.
Max. working pressure: 10 bar.
Max. inlet temperature: 90°C.
Certified to EN 15092.
PATENT.



Code	Temperature adjustment	Kv (m ³ /h)		
521814	1/2"	45-65°C	1,5	1 10
521815	3/4"	45-65°C	1,7	1 10
521816	1"	45-65°C	3,0	1 5

With check valves and strainers

Code	Temperature adjustment	Kv (m ³ /h)		
521914	1/2"	35-65°C	1,5	1 10
521915	3/4"	35-65°C	1,7	1 10
521916	1"	35-65°C	3,0	1 5

European certification

European standard EN 15092 "Inline hot water supply tempering valves. - Tests and requirements" specifies the performance characteristics for tempering valves installed at the point of distribution in domestic water systems made in accordance with the recent European standards EN 806-1/2/3/4/5. The 5218 series tempering valves are certified as compliant with these standards by the certification agency Buildcert and DTC (UK).

Application diagram of thermostatic mixing valve 5218 series

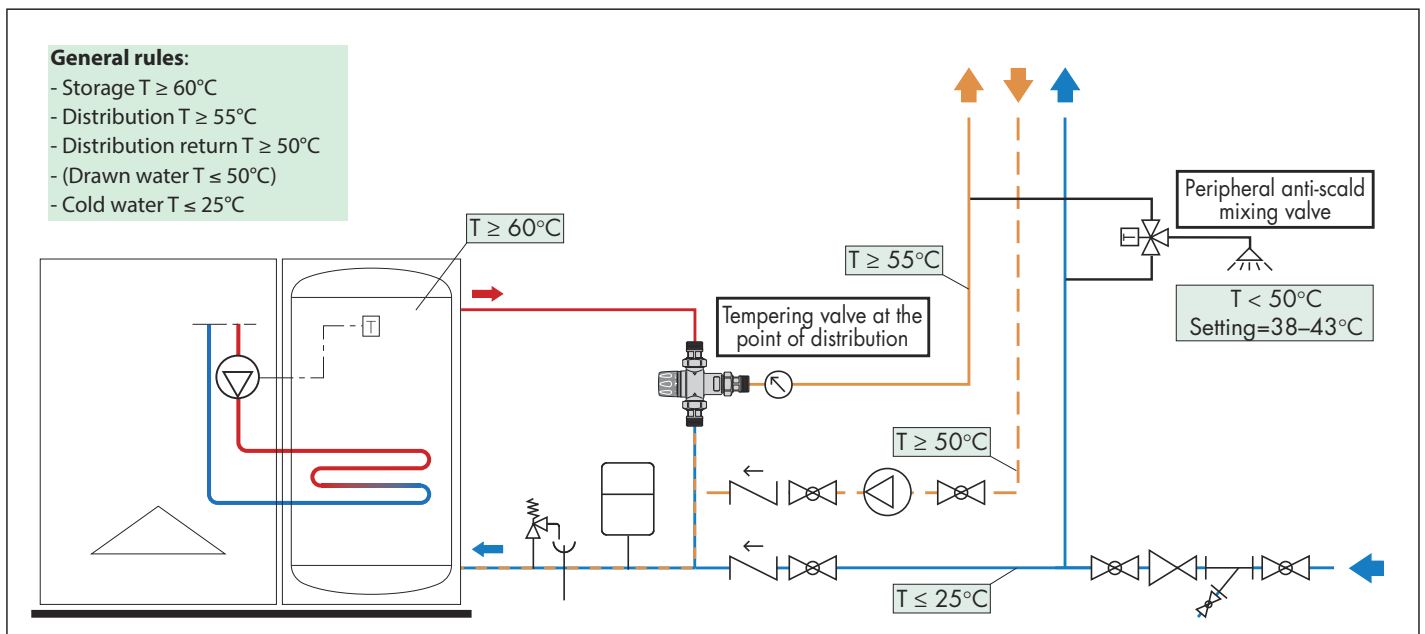



ANTI-SCALD THERMOSTATIC MIXING VALVES FOR INSTALLATION AT THE POINT OF USE

5213  tech. broch. 01092

Adjustable thermostatic mixing valve with check valves and strainers at the inlets. Enhanced thermal performance device with anti-scald safety function.

CR dezincification resistant alloy body. Chrome plated.
Max. working pressure: 10 bar.
Max. inlet temperature: 85°C.
Certified to NHS D08, BS 7942, EN 1111 and EN 1287.



Code	Temperature adjustment	Kv (m³/h)		
521304	1/2"	30–50°C	1	10
521303	3/4"	30–50°C	1	10

Adjustment temperature of mixing valve 5213 series

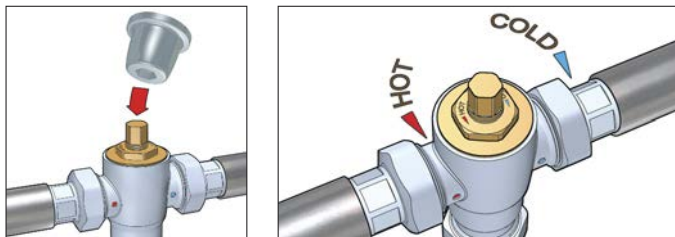

Application diagram of mixing valve 5213 series at point of use

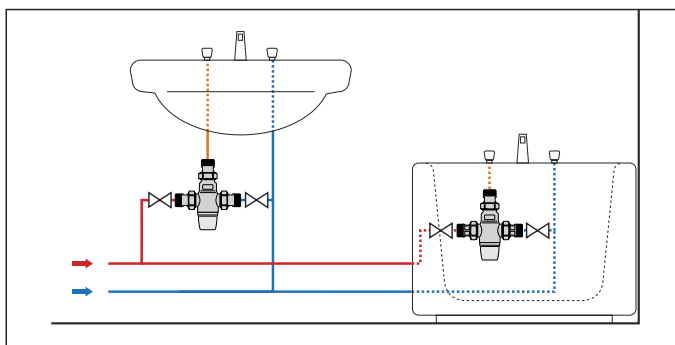



5213  tech. broch. 01092

Adjustable thermostatic mixing valve with check valves, strainers and compression ends. Enhanced thermal performance device with anti-scald safety function.

CR dezincification resistant alloy body. Chrome plated.
Max. working pressure: 10 bar.
Max. inlet temperature: 85°C.
Certified to NHS D08, BS 7942, EN 1111 and EN 1287.



Code	Temperature adjustment	Kv (m³/h)		
521315	Ø 15	30–50°C	1	10
521322	Ø 22	30–50°C	1	10

Application diagram of mixing valve 5213 series

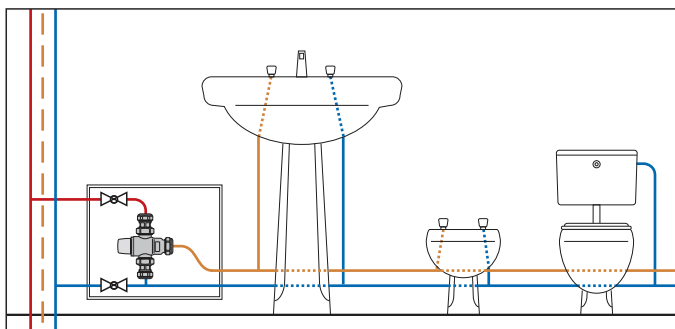



5217  tech. broch. 01145

Thermostatic mixing valve, adjustable with knob, with check valves and strainers at the inlets. Enhanced thermal performance device with anti-scald safety function.

CR dezincification resistant alloy body. Chrome plated.
Max. working pressure: 10 bar.
Max. inlet temperature: 85°C.
Certified to NF 079 Doc. 8.



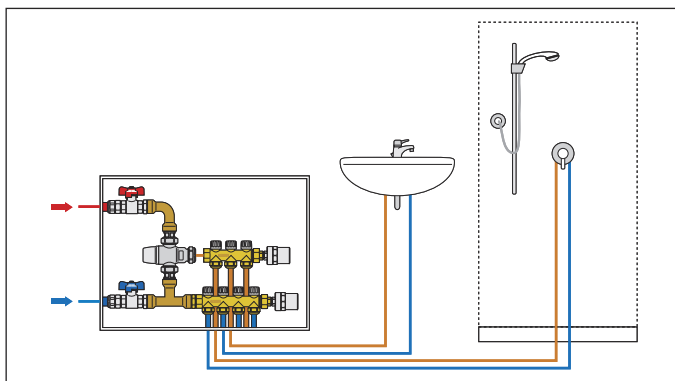

Code	Temperature adjustment	Kv (m³/h)		
521714	1/2"	30–50°C	1	10
521713	3/4"	30–50°C	1	10

Application diagram of mixing valve 5213 series with distribution group



Pre-formed shell insulation for 1/2" and 3/4" thermostatic mixing valves 5213, 5217, 5218 and 5219 series.

Code		
CBN521814	1	-
CBN521815	1	-

ANTI-SCALD TEMPERING AND THERMOSTATIC MIXING VALVES



5213



Adjustable anti-scald tempering valve with check valves and strainers at the inlets.
CR dezincification resistant alloy body. Chrome plated.
 Male union connections.
 Max. working pressure: 1400 kPa.
 Max. inlet temperature: 85°C.
Certified to AS 4032.2, NHS D08, BS 7942, EN 1111 and EN 1287.



Code	Temperature adjustment	Kv (m ³ /h)		
521312 AUS	DN 15 30–50°C	1,5	1	10
521319 AUS	DN 20 30–50°C	1,7	1	10



5213



Adjustable thermostatic mixing valve with check valves and strainers.
 Enhanced thermal performance device with anti-scald safety function.
CR dezincification resistant alloy body. Chrome plated.
 Male union connections.
 Max. working pressure: 1400 kPa.
 Max. inlet temperature: 85°C.
Certified to AS 4032.1, NHS D08, BS 7942, EN 1111 and EN 1287.



Code	Temperature adjustment	Kv (m ³ /h)		
521312TM AUS	DN 15 30–50°C	1,5	1	10
521319TM AUS	DN 20 30–50°C	1,7	1	10

5213



Adjustable thermostatic mixing valve with isolating valves, check valves and strainers at the inlets.
 Enhanced thermal performance device with anti-scald safety function.
CR dezincification resistant alloy body. Chrome plated.
 Max. working pressure: 1400 kPa.
 Max. inlet temperature: 85°C.
Certified to AS 4032.1.



Code	Temperature adjustment	Kv (m ³ /h)		
521312TMX AUS	1/2" 30–50°C	1,3	1	10
521319TMX AUS	3/4" 30–50°C	1,4	1	10

"L" PATTERN ADJUSTABLE THERMOSTATIC MIXING VALVE



5200



tech. broch. 01266



Adjustable thermostatic mixing valve with knob, complete with check valves and strainers at the inlets.
CR dezincification resistant alloy body "LOW LEAD".
 Male union connections.
 Max. working pressure: 10 bar.
 Max. inlet temperature: 90°C.
Certified to EN 1111 and EN 1287.



Code	Body DN	Conn.	Temperature adjustment	Kv (m ³ /h)		
520040	15	1/2"	35–65°C	1,5	1	10
520050	20	3/4"	35–65°C	1,7	1	10
520060	25	1"	35–65°C	3,0	1	5

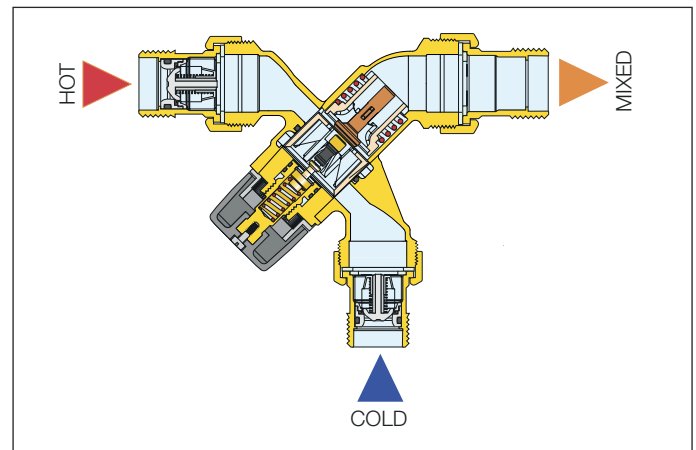

Application diagrams

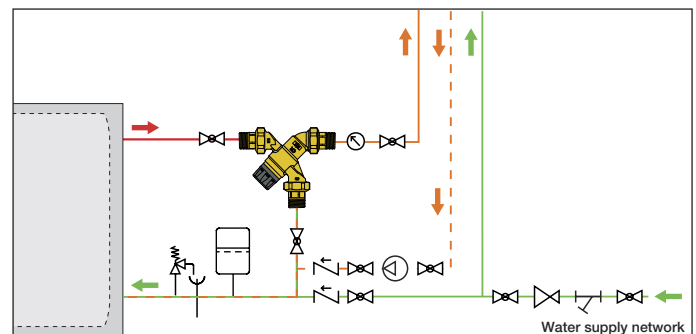
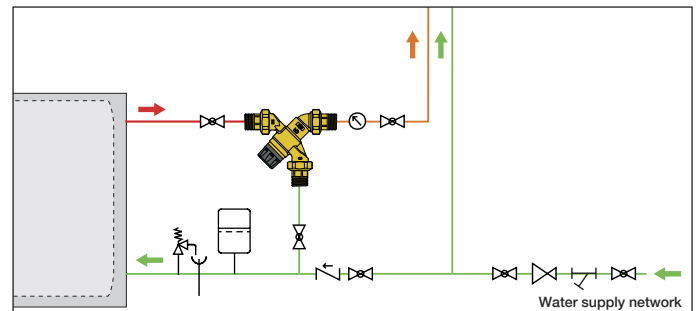

CONTROL UNIT FOR DOMESTIC HOT WATER TEMPERATURE



5201



Control unit for domestic hot water temperature at the point of distribution.

Consisting of:

- thermostatic mixing valve with thermal shut-off function,
- tee for cold water connection complete with check valves.

Max. working pressure: 10 bar.
Max. inlet temperature: 90°C.

Code	Body DN	Conn.	Temperature adjustment	Kv (m³/h)		
520150	20	3/4"	35-65°C	1,7	1	-
520160	25	1"	35-65°C	3,0	1	-

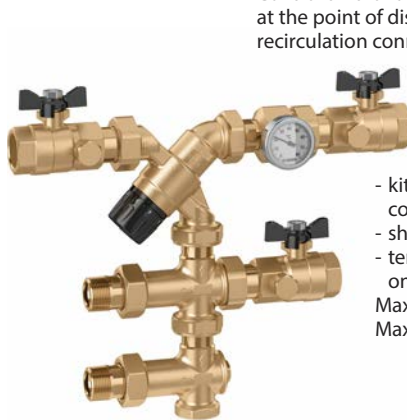

5201



Control unit for domestic hot water temperature at the point of distribution, complete with recirculation connection. Consisting of:

- thermostatic mixing valve with thermal shut-off function,
- tee for cold water connection complete with check valves,

- kit for recirculation connection complete with check valves,
- shut-off valves,
- temperature gauge with pocket on the mixed water outlet.

Max. working pressure: 10 bar.
Max. inlet temperature: 90°C.

Code	Body DN	Conn.	Temperature adjustment	Kv (m³/h)		
520155	20	3/4"	35-65°C	1,7	1	-



520



Accessory kit for recirculation connection complete with check valves.

Max. working pressure: 10 bar.
Max. inlet temperature: 90°C.

Code	Body DN	Conn.		
520005	20	3/4"	1	-

Specifications

The control unit for domestic hot water temperature is equipped with a high performance thermostatic mixing valve with a thermal shut-off function. This makes it possible to maintain a flow temperature at the distribution point that is perfectly stable at the required value.

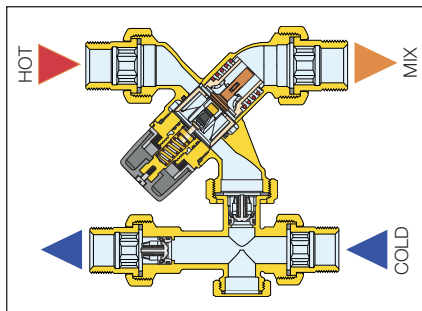

The domestic hot water temperature control unit allows easy **connection between pipes serving the domestic hot water and storage system**, making it possible to minimise space requirements for installation. The unit is supplied with the **check valves that allow correct operation of the mixing valve in the presence of recirculation**. The group's modularity makes it extremely flexible, since it allows orientation of the various pipe connections in accordance with installation requirements. The shut-off valves with connection ports and temperature gauge on the mixed water outlet facilitate commissioning, checking and maintenance operations.

Interchangeable cold/recirculation connections

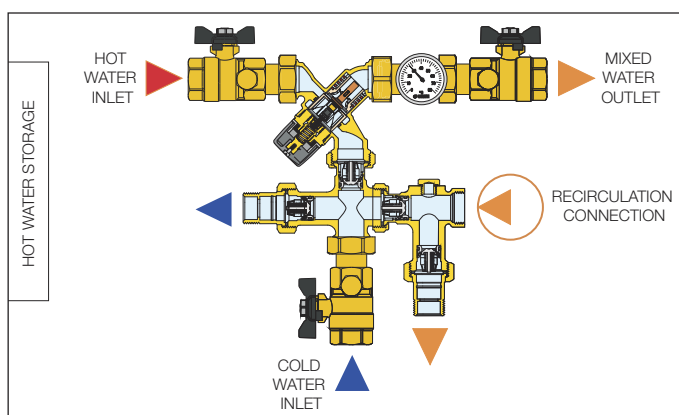
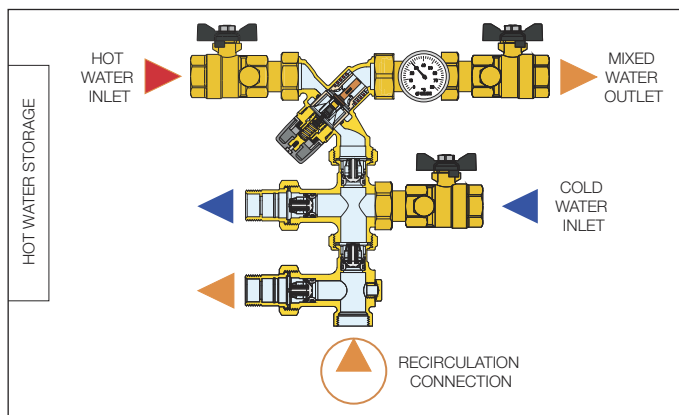

Without recirculation circuit

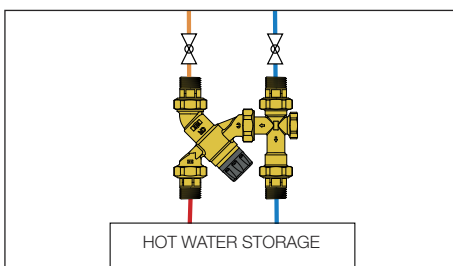

Storage without recirculation connection

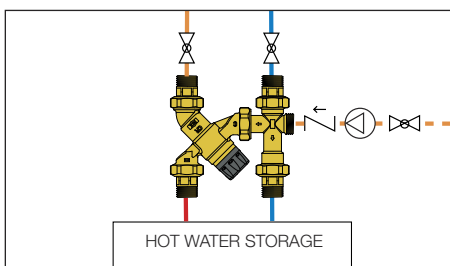

Storage with recirculation connection

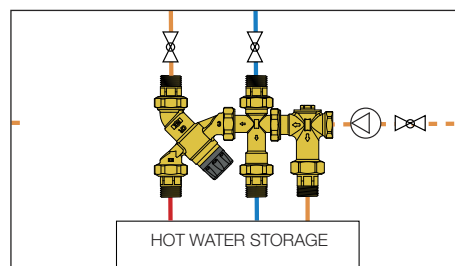

THERMOSTATIC MIXING VALVES FOR MEDIUM-LARGE APPLICATIONS

5231

tech. broch. 01256



Adjustable thermostatic mixing valve, for centralised systems.
 CR dezincification resistant alloy body.
 Antiscale inner regulator in technopolymer.
 Max. working pressure: 14 bar.
 Max. inlet temperature: 90°C.



Code	Temperature adjustment	Kv (m³/h)		
523140	1/2"	35-65°C 4,3	1	5
523150	3/4"	35-65°C 4,5	1	5
523160	1"	35-65°C 5,5	1	-
523170	1 1/4"	35-65°C 7,6	1	-
523180	1 1/2"	35-65°C 11,0	1	-
523190	2"	35-65°C 13,3	1	-

With check valves and compression ends

Code	Temperature adjustment	Kv (m³/h)		
523162	Ø 28	35-65°C 7,6	1	-

5230

tech. broch. 01080



Adjustable thermostatic mixing valve, with replaceable cartridge, for centralised systems.
 Brass body.
 Max. working pressure: 14 bar.
 Max. inlet temperature: 85°C.



Code	Temperature adjustment	Kv (m³/h)		
523040	1/2"	30-65°C 4,0	1	-
523050	3/4"	30-65°C 4,5	1	-
523060	1"	30-65°C 6,9	1	-
523070	1 1/4"	30-65°C 9,1	1	-
523080	1 1/2"	36-60°C 14,5	1	-
523090	2"	36-60°C 19,0	1	-

With check valves

Code	Temperature adjustment	Kv (m³/h)		
523043	1/2"	30-65°C 4,0	1	-
523053	3/4"	30-65°C 4,5	1	-
523063	1"	30-65°C 6,9	1	-
523073	1 1/4"	30-65°C 9,1	1	-

With check valves and compression ends

Code	Temperature adjustment	Kv (m³/h)		
523052	Ø 22	30-65°C 4,5	1	-
523062	Ø 28	30-65°C 6,9	1	-

Application diagram of mixing valve 5231 series

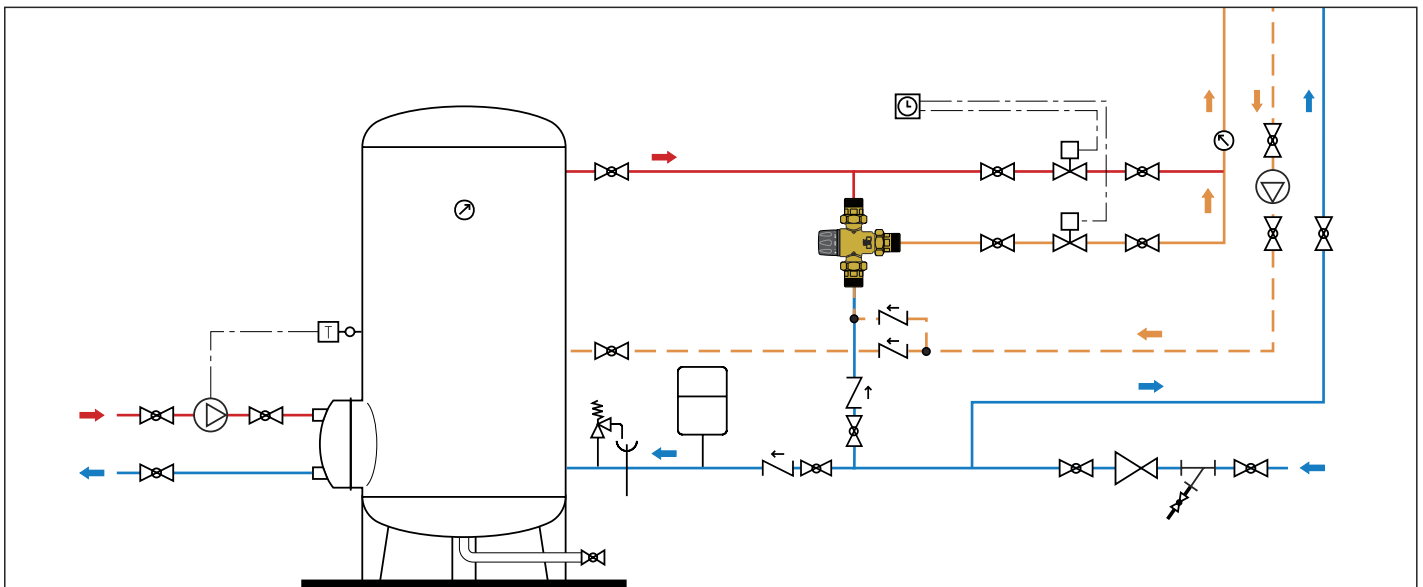

THERMOSTATIC MIXING VALVE FOR MEDIUM-LARGE APPLICATIONS



524

Adjustable thermostatic mixing valve for centralised systems. With recirculation connection. Male threaded connections. Brass body. Max. working pressure: 10 bar. Max. inlet temperature: 90°C.



524



tech. broch. 01080

Adjustable thermostatic mixing valve. Bronze body, PN 10. Flanged connections. Equipped with flat counterflanges EN 1092-1, PN 10. Recirculation pipe connections. Factory setting: 48°C. Max. working pressure: 10 bar. Max. inlet temperature: 90°C.

Code	Body DN	Temperature adjustment	Kv (m³/h)		
524400*	15 1 1/8"	30-65°C	1,4	1	-
524500	20 1 1/4"	30-65°C	2,5	1	-
524600	25 1 1/2"	30-65°C	4,0	1	-
524700	32 2"	30-65°C	7,7	1	-
524800	40 2 1/4"	36-60°C	11,5	1	-
524900	50 2 3/4"	36-60°C	15,0	1	-

* Without recirculation connection



524



Connection kit for mixing valves with threaded connections, 524 series. Complete with:
 - 2 female unions with check valves, strainers and seals;
 - 1 female union with seal.

Code	Size	For		
524004	1/2"	for 524400	1	-
524005	3/4"	for 524500	1	-
524006	1"	for 524600	1	-
524007	1 1/4"	for 524700	1	-
524008	1 1/2"	for 524800	1	-
524009	2"	for 524900	1	-

Code	Body DN	Temperature adjustment	Kv (m³/h)		
524060	DN 65	36-53°C (±2°C)	32,0	1	-
524080	DN 80	36-53°C (±2°C)	43,0	1	-

Application diagram of mixing valve 524 series

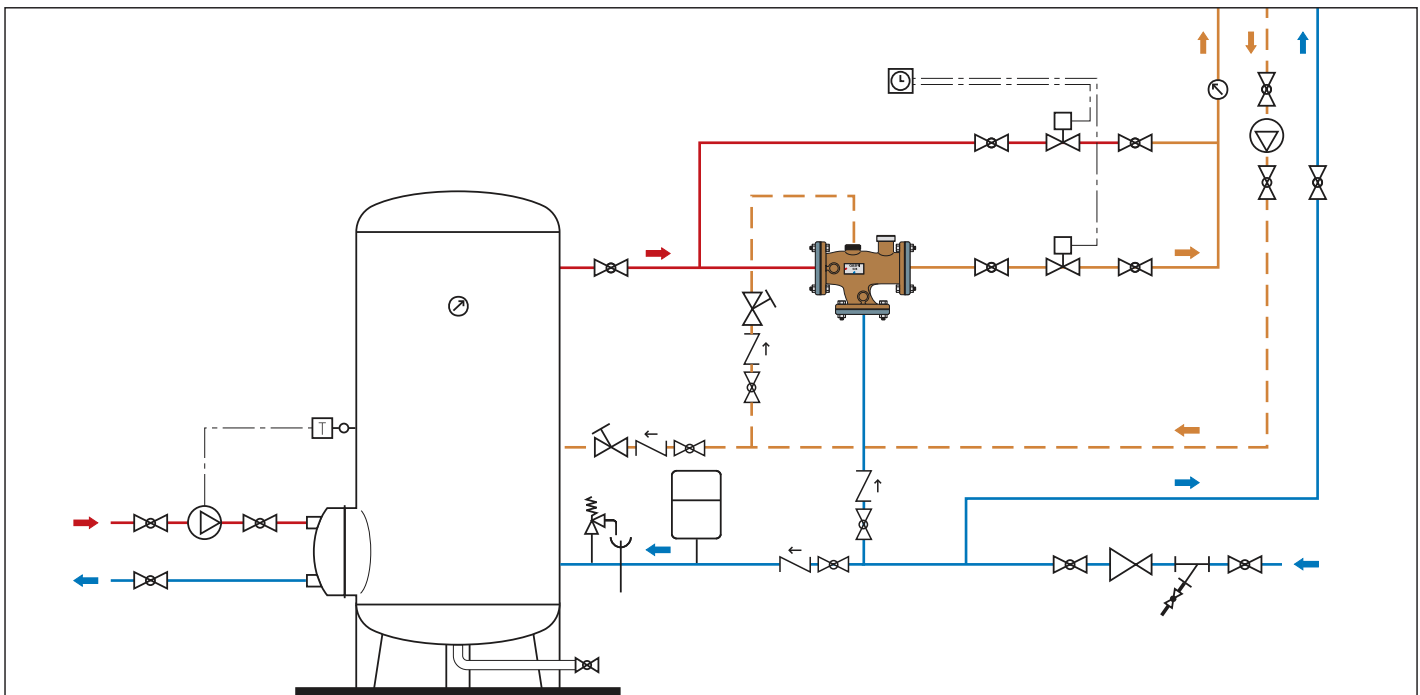

HYBRID ELECTRONIC MIXING VALVE

NEW

6000 EST
LEGIOMIX® 2.0

tech. broch. 01334

Operating principle

Hybrid electronic mixing valve.

Complete with:

- hybrid mixing valve with motorised actuator
- electronic regulator with programming of temperature levels and thermal disinfection cycles, built into the actuator casing
- integrated flow temperature probe
- circuit return temperature probe
- flow temperature gauge.

Fitted for data saving function (optional), with recording of temperatures and functional parameters. Fitted for connection to remote control system (optional).

CR dezincification resistant alloy body.

Electric supply: 230 V - 50/60 Hz.

Max working pressure: 10 bar.

Max. inlet temperature: 90°C.

Adjustment temperature range in mixing mode: 35–65°C.

Disinfection temperature range: 50–85°C.

Protection class: IP 54.

The electronic hybrid mixing valve combines the typical function of the mechanical thermostatic mixing valve and the management efficiency of an electronic mixing valve in a single device.

The thermostatic mixing valve uses the mechanical action performed by the internal control thermostatic element, which responds promptly to any variation in temperature, pressure and inlet flow rate to quickly restore the mixed water temperature value at the outlet.

Fast and accurate temperature control guaranteed, indispensable for use in domestic hot water distribution circuits.

This basic mixer is effectively managed by a motor-controlled actuator that, based on a signal coming from the temperature probes and under the control of a specific regulator, modifies the set point temperature of the mixed water. The latter is monitored continuously by means of temperature probes, which indicate the operation status of the domestic water circuit.



The electronic regulator, directly on the actuator, allows the mixed water temperature control according to different functional programs, both for normal control and for the thermal disinfection for the prevention of Legionella. This phase can be controlled and checked automatically in terms of temperatures and disinfection times, for optimal system management.

An optional memory system allows continuous recording of flow temperature, return temperature, alarm and functional statuses, useful for monitoring the operating status of the entire system.

Appropriate relays are used to manage the alarms and external appliances, for example for loading accumulation hot water and switching on/off the recirculation pump.

The regulator is fitted for remote control with specific MODBUS-RTU transmission protocols, through optional board, for use in Building Management Systems (BMS).



Code	Body DN	Conn.	Kv (m³/h)		
600045 EST	15	1/2"	4,3	1	–
600055 EST	20	3/4"	4,3	1	–
600065 EST	25	1"	7,6	1	–
600075 EST	32	1 1/4"	10,0	1	–
600085 EST	40	1 1/2"	13,0	1	–
600095 EST	50	2"	18,0	1	–

Characteristic components

- 1 Digital regulator with actuator in single casing
- 2 Control knob and LCD display
- 3 Fitted for cable seals and cable glands, with holes
- 4 Valve body
- 5 Mixed water temperature probe
- 6 Mixed water temperature gauge
- 7 System return temperature probe and probe holder

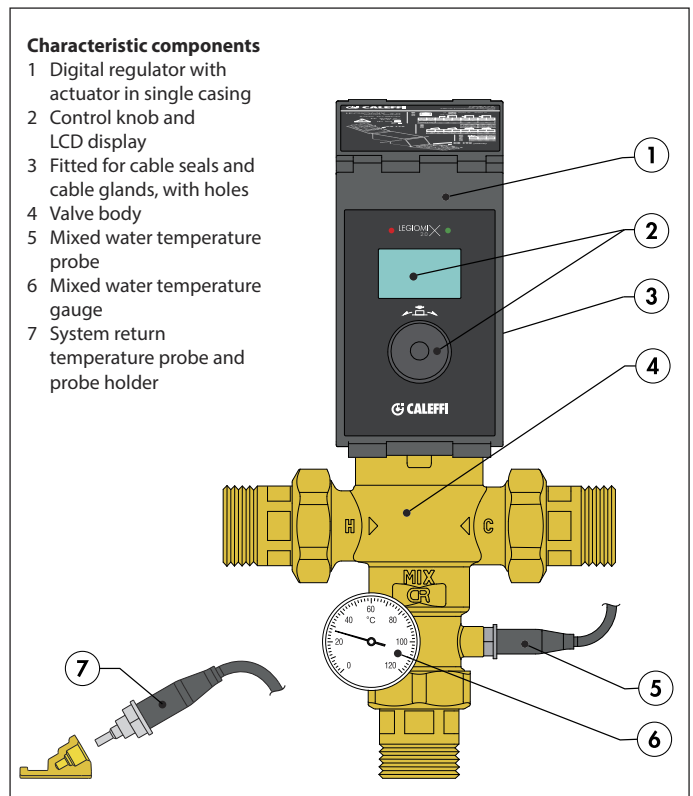

ACCESSORIES FOR HYBRID ELECTRONIC MIXING VALVE

NEW

Code 600001

Optional board MODBUS-RTU transmission and logs

By installing the board on the device, it will be possible to manage the device through a specific MODBUS-RTU transmission protocol for use in Building Management Systems (BMS). The package includes the optional board, main board connection cable and logs.

Code 600002

RS-485 USB cable and Caleffi Software

Using the cable with RS-485 USB interface and the Caleffi Software included in the package, it is possible to manage the device from PC.

Code

600001	optional board and logs	1	-
---------------	-------------------------	---	---

Code

600002	RS-485 USB cable and Caleffi Software	1	-
---------------	---------------------------------------	---	---

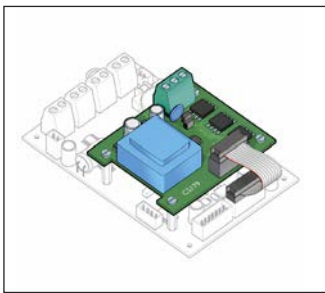
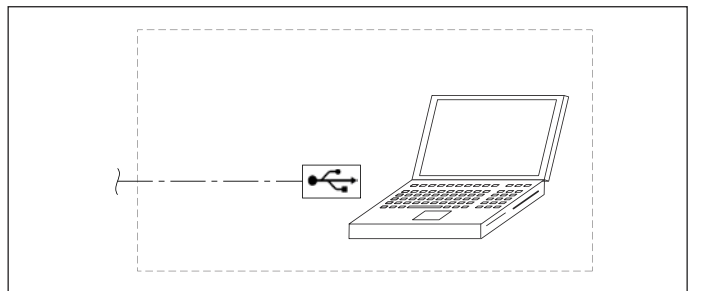

REG.	TYPE	DESCRIPTION	READ	VALUE
1	1	Temperature sensor	0x00000000	0.00
2	1	Temperature sensor	0x00000000	0.00
3	1	Temperature sensor	0x00000000	0.00
4	1	Temperature sensor	0x00000000	0.00
5	1	Temperature sensor	0x00000000	0.00
6	1	Temperature sensor	0x00000000	0.00
7	1	Temperature sensor	0x00000000	0.00
8	1	Temperature sensor	0x00000000	0.00
9	1	Temperature sensor	0x00000000	0.00
10	1	Temperature sensor	0x00000000	0.00
11	1	Temperature sensor	0x00000000	0.00
12	1	Temperature sensor	0x00000000	0.00
13	1	Temperature sensor	0x00000000	0.00
14	1	Temperature sensor	0x00000000	0.00
15	1	Temperature sensor	0x00000000	0.00
16	1	Temperature sensor	0x00000000	0.00
17	1	Temperature sensor	0x00000000	0.00
18	1	Temperature sensor	0x00000000	0.00
19	1	Temperature sensor	0x00000000	0.00
20	1	Temperature sensor	0x00000000	0.00
21	1	Temperature sensor	0x00000000	0.00
22	1	Temperature sensor	0x00000000	0.00
23	1	Temperature sensor	0x00000000	0.00
24	1	Temperature sensor	0x00000000	0.00
25	1	Temperature sensor	0x00000000	0.00
26	1	Temperature sensor	0x00000000	0.00
27	1	Temperature sensor	0x00000000	0.00
28	1	Temperature sensor	0x00000000	0.00
29	1	Temperature sensor	0x00000000	0.00
30	1	Temperature sensor	0x00000000	0.00
31	1	Temperature sensor	0x00000000	0.00
32	1	Temperature sensor	0x00000000	0.00
33	1	Temperature sensor	0x00000000	0.00
34	1	Temperature sensor	0x00000000	0.00
35	1	Temperature sensor	0x00000000	0.00
36	1	Temperature sensor	0x00000000	0.00
37	1	Temperature sensor	0x00000000	0.00
38	1	Temperature sensor	0x00000000	0.00
39	1	Temperature sensor	0x00000000	0.00
40	1	Temperature sensor	0x00000000	0.00
41	1	Temperature sensor	0x00000000	0.00
42	1	Temperature sensor	0x00000000	0.00
43	1	Temperature sensor	0x00000000	0.00
44	1	Temperature sensor	0x00000000	0.00
45	1	Temperature sensor	0x00000000	0.00
46	1	Temperature sensor	0x00000000	0.00
47	1	Temperature sensor	0x00000000	0.00
48	1	Temperature sensor	0x00000000	0.00
49	1	Temperature sensor	0x00000000	0.00
50	1	Temperature sensor	0x00000000	0.00
51	1	Temperature sensor	0x00000000	0.00
52	1	Temperature sensor	0x00000000	0.00
53	1	Temperature sensor	0x00000000	0.00
54	1	Temperature sensor	0x00000000	0.00
55	1	Temperature sensor	0x00000000	0.00
56	1	Temperature sensor	0x00000000	0.00
57	1	Temperature sensor	0x00000000	0.00
58	1	Temperature sensor	0x00000000	0.00
59	1	Temperature sensor	0x00000000	0.00
60	1	Temperature sensor	0x00000000	0.00
61	1	Temperature sensor	0x00000000	0.00
62	1	Temperature sensor	0x00000000	0.00
63	1	Temperature sensor	0x00000000	0.00
64	1	Temperature sensor	0x00000000	0.00
65	1	Temperature sensor	0x00000000	0.00
66	1	Temperature sensor	0x00000000	0.00
67	1	Temperature sensor	0x00000000	0.00
68	1	Temperature sensor	0x00000000	0.00
69	1	Temperature sensor	0x00000000	0.00
70	1	Temperature sensor	0x00000000	0.00
71	1	Temperature sensor	0x00000000	0.00
72	1	Temperature sensor	0x00000000	0.00
73	1	Temperature sensor	0x00000000	0.00
74	1	Temperature sensor	0x00000000	0.00
75	1	Temperature sensor	0x00000000	0.00
76	1	Temperature sensor	0x00000000	0.00
77	1	Temperature sensor	0x00000000	0.00
78	1	Temperature sensor	0x00000000	0.00
79	1	Temperature sensor	0x00000000	0.00
80	1	Temperature sensor	0x00000000	0.00
81	1	Temperature sensor	0x00000000	0.00
82	1	Temperature sensor	0x00000000	0.00
83	1	Temperature sensor	0x00000000	0.00
84	1	Temperature sensor	0x00000000	0.00
85	1	Temperature sensor	0x00000000	0.00
86	1	Temperature sensor	0x00000000	0.00
87	1	Temperature sensor	0x00000000	0.00
88	1	Temperature sensor	0x00000000	0.00
89	1	Temperature sensor	0x00000000	0.00
90	1	Temperature sensor	0x00000000	0.00
91	1	Temperature sensor	0x00000000	0.00
92	1	Temperature sensor	0x00000000	0.00
93	1	Temperature sensor	0x00000000	0.00
94	1	Temperature sensor	0x00000000	0.00
95	1	Temperature sensor	0x00000000	0.00
96	1	Temperature sensor	0x00000000	0.00
97	1	Temperature sensor	0x00000000	0.00
98	1	Temperature sensor	0x00000000	0.00
99	1	Temperature sensor	0x00000000	0.00
100	1	Temperature sensor	0x00000000	0.00



Application diagram of electronic mixing valve 6000 EST LEGIOMIX® 2.0 series

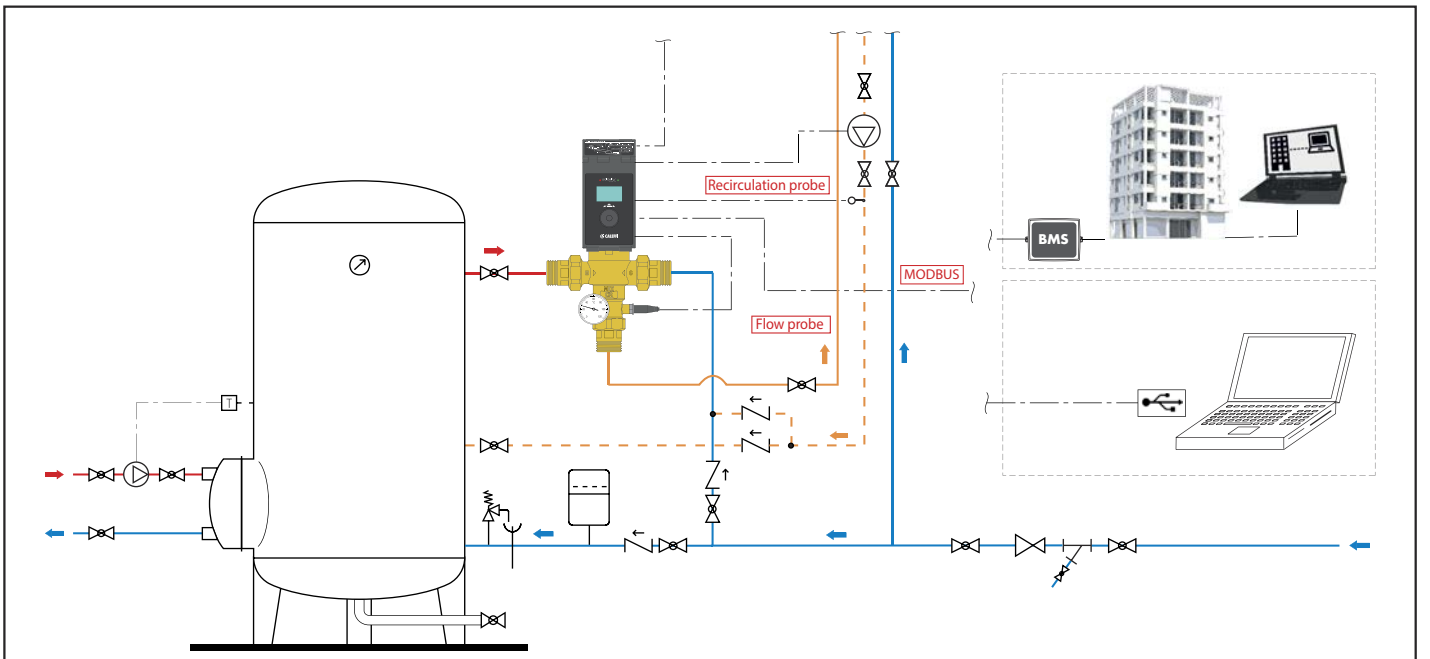

ELECTRONIC MIXING VALVE WITH PROGRAMMABLE THERMAL DISINFECTION

6000 LEGIOMIX®



Electronic mixing valve with programmable thermal disinfection and check on disinfection. Male threaded connections with union.

- Consisting of:
- **three-way ball valve,**
- **actuator,**
- **regulator,**
- **flow temperature probe,**
- **return temperature probe.**

With auxiliary microswitches for disinfection management and other devices.

Available version with a monitoring and remote control connection with RS-485 and MODBUS-RTU protocols.

Supply: 230 V - 50/60 Hz - (6,5+6) VA.

Adjustment temperature range: 20–85°C.

Disinfection temperature range: 40–85°C.

Max. working pressure: 10 bar.

Max. inlet temperature: 100°C.

Protection class: IP 65 (actuator).



Code		Kv (m³/h)		
600051	3/4"	8,4	1	–
600061	1"	10,6	1	–
600071	1 1/4"	21,2	1	–
600081	1 1/2"	32,5	1	–
600091	2"	41,0	1	–

Function

This particular series of electronic mixing valves is equipped with a special regulator **that controls a set of programs for circuit thermal disinfection.** In addition it enables checking the temperature and time for thermal disinfection are actually reached and undertaking the appropriate corrective action. All the parameters are updated every day and logged, recording the temperatures by time.

Spare parts for mixing valve.

Consisting of:

- **three-way ball valve,**
- **actuator,**
- **flow temperature probe.**

Code

600251	for code 600051
600261	for code 600061
600271	for code 600071
600281	for code 600081
600291	for code 600091

Spare parts for electronic mixing valve with programmable thermal disinfection 6000 series with threaded connections.

Code

645112	actuator 230 V (ac) for 600051–600091
F69798	body valve without unions and probe holder for code 600051
F69799	body valve without unions and probe holder for code 600061
F69801	body valve without unions and probe holder for code 600071
F69803	body valve without unions and probe holder for code 600081/91
F69807	flow probe for 3/4"-1"-1 1/4"
F69804	flow probe for 1 1/2"-2"
F69591	recirculation probe for check on disinfection
F69531	contact probe holder for recirculation loop
F69433	regulator with check on disinfection
R19101	temperature gauge
F69888	spare battery

ANTI-SCALD DEVICE



6001



Anti-scald device for domestic hot water use. Brass body. Chrome plated. Setting temperature: 48°C (±1°C).



Function

The purpose of the anti-scald device is to cut off the flow of water if its temperature reaches the setting value. Designed to be used in domestic hot water systems with electronic mixing valves with programmable thermal disinfection. Installed directly at the point of use, it prevents the hot water from scalding the user during the thermal disinfection period (T>50°C).

Code			
600140	1/2"	1	10

ELECTRONIC MIXING VALVE WITH PROGRAMMABLE THERMAL DISINFECTION

6000 LEGIOMIX®

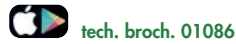

Electronic mixing valve with programmable thermal disinfection and check on disinfection. Flanged connections. Consisting of:

- **three-way ball valve,**
- **actuator,**
- **regulator,**
- **flow temperature probe,**
- **return temperature probe.**

With auxiliary microswitches for disinfection management and other devices.

Available version with a monitoring and remote control connection with RS-485 and MODBUS-RTU protocols.

Supply: 230 V - 50/60 Hz - (6,5+10,5) VA.

Adjustment temperature range: 20–85°C.

Disinfection temperature range: 40–85°C.

To be coupled with flat counterflanges EN 1092-1, PN 16.

Max. working pressure: 10 bar.

Max. inlet temperature: 100°C.

Protection class: IP 65 (actuator).



Code		Kv (m³/h)		
600006	DN 65	90,0	1	–
600008	DN 80	120,0	1	–

Spare parts for electronic mixing valve with programmable thermal disinfection 6000 series with flanged connections.

Code

F69381	flow or return temperature probe
F69393	three-way valve with flanged connections for 600006
F69394	three-way valve with flanged connections for 600008
F69395	actuator 230 V (ac) for 600006 and 600008
F69433	regulator with check on disinfection
F69591	recirculation probe for check on disinfection
F69531	contact probe holder for recirculation loop



7550

MODBUS-RTU/BACnet converter for connection with BMS systems.

Interface for products with MODBUS-RTU transmission with systems using BACnet protocol.

Supply:

9-30 V (dc), 12-24 V (ac), 50/60 Hz

2,5 W / 12 V 150 mA.

Certification: CE, IEC, FCC, RHOS.

Inputs/Outputs:

Ethernet port 10/100

RS-485 port +/-GND

Working temperature: -40–75°C.

Relative humidity: 5-90% with no condensation.



The converter is preconfigured for use with the following products:

- LEGIOMIX® 6000 series (for MODBUS-RTU version)
- LEGIOMIX® 2.0 6000 EST series
- CONTECA EASY 750. series.



Code

755052			1	–
---------------	--	--	---	---

Application diagram of electronic mixing valve 6000 series

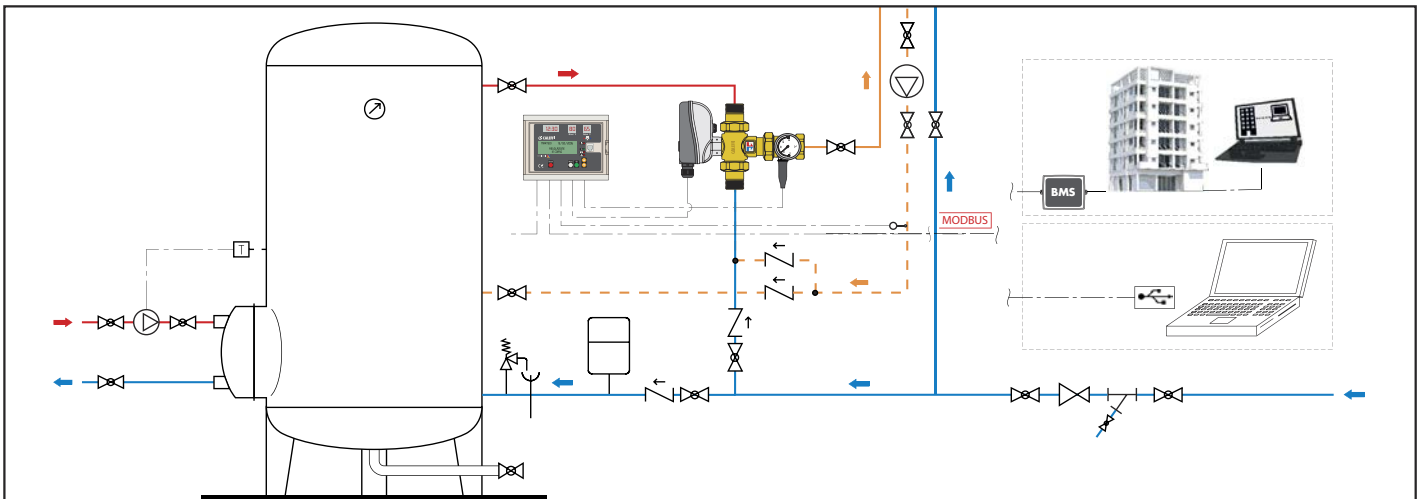

UNIT FOR TEMPERATURE CONTROL AND THERMAL DISINFECTION

6005 LEGIOFLOW®

tech. broch. 01160

Multi-function compact unit for temperature control, thermal disinfection and distribution for domestic water system. Consisting of:
 - anti-scald thermostatic mixing valve,
 - automatic flushing valve for thermal disinfection with thermo-electric actuator,
 - shut-off ball valve with built-in strainers and check valves,
 - cold water circuit outlet kit.

Inlet connections: 3/4" M.
 Outlet connections: 3/4" M with union.



Mixing valve
 CR dezincification resistant alloy body.
 Max. working pressure: 10 bar.
 Adjustment temperature range: 30–50°C.
 Factory setting: 43°C.
 Max. inlet temperature at primary circuit: 85°C.
 Performance to standards NF 079 doc. 8, EN 1111 and EN 1287.

Thermo-electric actuator
 Normally closed.
 Supply: 230 V (ac).
 Power consumption: 3 W.
 Protection class: IP 44.
 Cable length: 80 cm.



With thermo-electric actuator

Code	Connections	Kv (m³/h) mixing valve	Kv (m³/h) flushing valve		
600500	3/4"	1,75	1,80	1	6

Without thermo-electric actuator

Code	Connections	Kv (m³/h) mixing valve	Kv (m³/h) flushing valve		
600501	3/4"	1,75	1,80	1	6



Version without cold water circuit outlet kit.
 For applications with push button or photo-cell activated user taps.



With thermo-electric actuator

Code	Connections	Kv (m³/h) mixing valve	Kv (m³/h) flushing valve		
600502	3/4"	1,75	1,80	1	6

Without thermo-electric actuator

Code	Connections	Kv (m³/h) mixing valve	Kv (m³/h) flushing valve		
600503	3/4"	1,75	1,80	1	6

6005 LEGIOFLOW®

tech. broch. 01160

Multi-function compact unit for temperature control, thermal disinfection and distribution for domestic water system. Consisting of:
 - anti-scald thermostatic mixing valve,
 - automatic flushing valve for thermal disinfection with thermo-electric actuator,
 - shut-off ball valve with built-in strainers and check valves,
 - cold water circuit outlet kit,
 - distribution manifolds with built-in shut-off valves,
 - box code 362056 (560x330x80 mm).

Mixing valve
 CR dezincification resistant alloy body.
 Max. working pressure: 10 bar.
 Adjustment temperature range: 30–50°C.
 Factory set: 43°C.
 Max. inlet temperature at primary circuit: 85°C.
 Performance to standards NF 079 doc. 8, EN 1111 and EN 1287.

Thermo-electric actuator
 Normally closed.
 Supply: 230 V (ac).
 Power consumption: 3 W.
 Protection class: IP 44.
 Cable length: 80 cm.

Distribution manifolds
 CR dezincification resistant alloy body.
 Max. working pressure: 10 bar.
 Working temperature range: 5–100°C.
 Outlet centre distance: 35 mm.

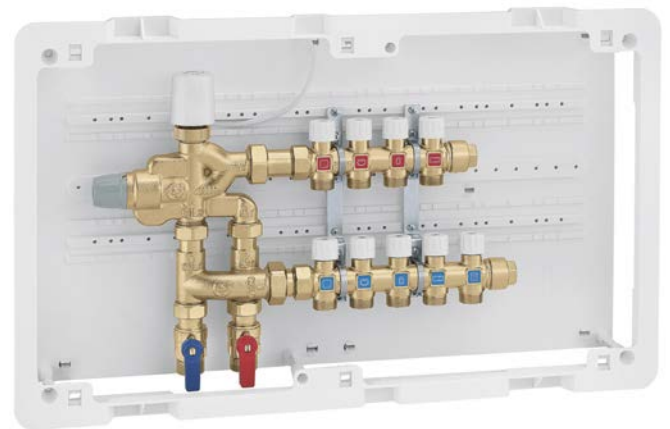

With thermo-electric actuator

Code	Connections	Outlets No. cold hot	Outlets		
600530	3/4"	3 2	23 p.1,5 M	1	–
600540	3/4"	4 3	23 p.1,5 M	1	–
600550	3/4"	5 4	23 p.1,5 M	1	–

Without thermo-electric actuator

Code	Connections	Outlets No. cold hot	Outlets		
600531	3/4"	3 2	23 p.1,5 M	1	–
600541	3/4"	4 3	23 p.1,5 M	1	–
600551	3/4"	5 4	23 p.1,5 M	1	–

UNIT FOR TEMPERATURE CONTROL AND THERMAL DISINFECTION

Thermal disinfection

To be more certain that there is no growth of Legionella, all sections of the network must be subjected to thermal disinfection. Even in the section downstream of the mixing valve, as far as the user tap, it must be possible to flush the system at temperatures exceeding 60°C. This means by-passing the thermostatic mixing valve, which is set at lower values, and activating another valve that allows the taps to be fed directly with the hot water arriving from the distribution network.

Function

The multi-function unit is used in domestic water systems to control the hot and cold water delivered to user taps, serving a bathroom or a dwelling. A high-performance adjustable thermostatic mixing valve keeps the hot water temperature at the desired level and protects the user from the danger of scalding.

A flushing valve is used for the circuit thermal disinfection all the way to the tap, in compliance with anti-Legionella regulations.

Hydraulic diagram

With mixing

- Flushing valve closed
- Cold water valve open

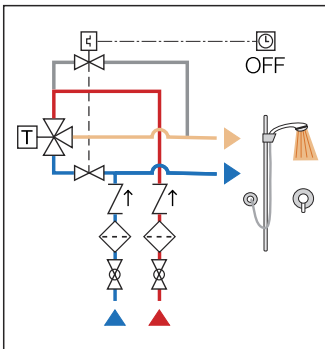

With thermal disinfection

- Flushing valve open
- Cold water valve closed

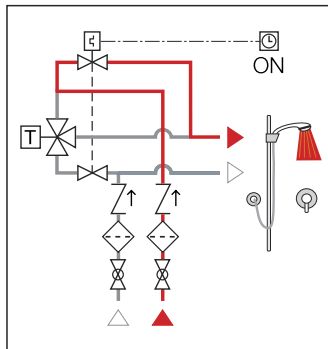

Temperature adjustment

Temperature adjustment

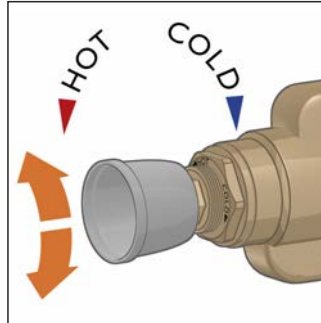

Adjustment locking using the locking nut

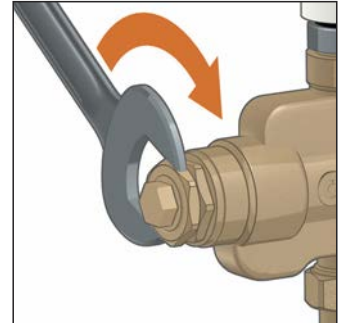

Manual opening

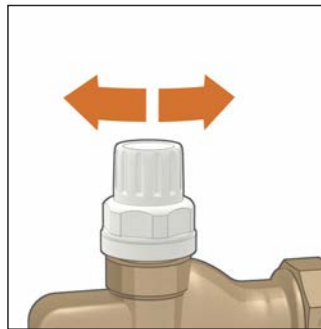

Thermo-electric actuator

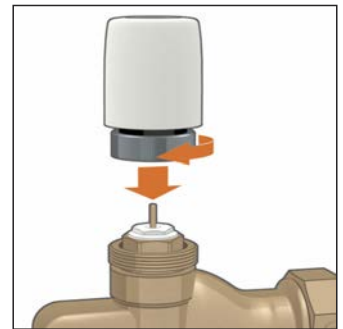

Application diagram multi-function unit code 600550

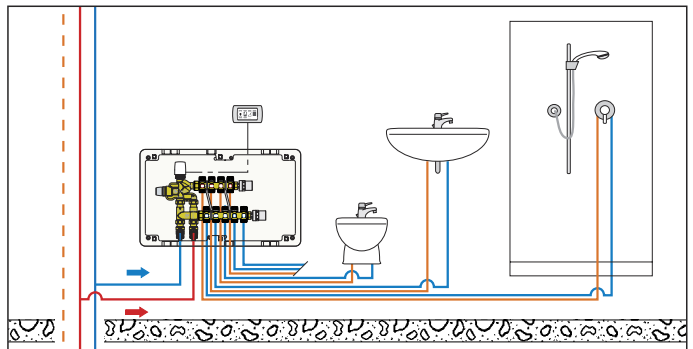

TIMER FOR VALVE OPERATION

6002

Timer with programmable key, settings from 0,25 to 15 minutes. To operate the valves used to carry out thermal disinfection of circuit sections, up to the taps. Supply: 230 V (ac).



Code

600200



1

-

MULTI-FUNCTION THERMOSTATIC REGULATOR



116

tech. broch. 01325

Thermostatic regulator for domestic hot water recirculation circuits. Complete with automatic thermostatic thermal disinfection function. With temperature gauge for circuit temperature check. **CR** dezincification resistant alloy body "LOW LEAD". Female connections. Max. working pressure: 16 bar. Adjustment temperature range: 35–60°C. Disinfection temperature: 70°C.



Code	DN	Conn.		
116240	15	1/2"	1	-
116250	20	3/4"	1	-



116

tech. broch. 01325

Thermostatic regulator for domestic hot water recirculation circuits. Fitted for automatic or controlled thermal disinfection function. With pocket for temperature gauge. **CR** dezincification resistant alloy body "LOW LEAD". Female connections. Max. working pressure: 16 bar. Adjustment temperature range: 35–60°C.



Code	DN	Conn.		
116140	15	1/2"	1	-
116150	20	3/4"	1	-

116

tech. broch. 01325

Cartridge for thermal disinfection function controlled by an actuator. For use with 116 series combined with 656. series actuators.



Code		
116000	1	-

NEW



Insulation for multifunction thermostatic regulator 116 series.

Code		
CBN116140	1	-



Accessory temperature gauge for multifunction thermostatic regulator 116 series. Temperature gauge scale: 0–80°C.

Code		
116010	1	-

Function

In domestic hot water distribution circuits, to respect modern plant requirements for the prevention of Legionnaires' disease, it is essential to ensure that all sections are kept at the correct temperature. The recirculation network must be balanced, to avoid non-uniform temperature distribution, with cold sections at risk of Legionella proliferation. The thermostatic regulator, installed on each return branch of the recirculation circuit, automatically maintains the set temperature. This device modulates the medium flow rate in accordance with the water inlet temperature by means of the action of a dedicated internal thermostatic cartridge. When the water temperature approaches the set value, the obturator progressively reduces the passage. The medium flow rate supplied by the recirculation pump is thus distributed to the other network branches, resulting in effective automatic thermal balancing. If necessary, the regulator is already equipped with a thermal disinfection function, which is useful if the system temperature is to be increased to values over 55–60°C. This function can be completely automatic, activated by a dedicated second thermostatic cartridge that trips at 70°C, or controlled with a thermo-electric actuator.

Cartridge replacement for electrically controlled disinfection

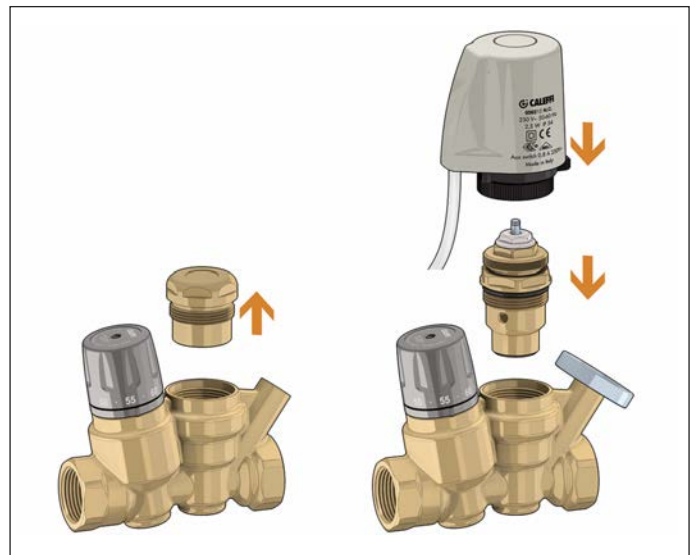

Application diagram of thermostatic regulator 116 series

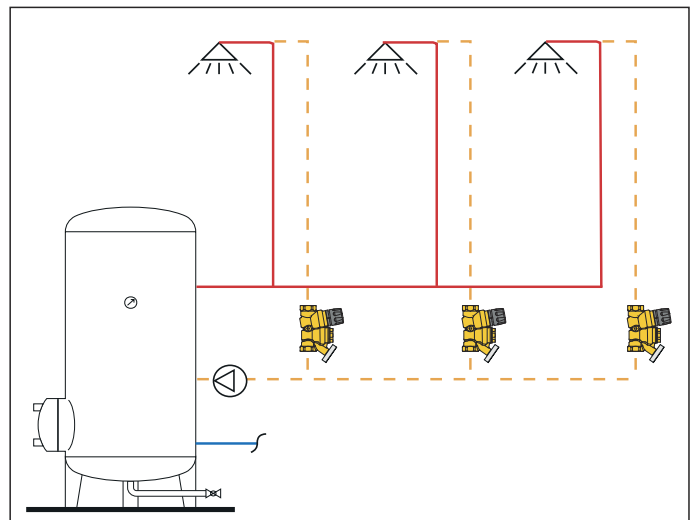

MULTI-FUNCTION THERMOSTATIC REGULATOR

Operating modes

Here following the regulator's operating modes according to the variation of the water temperature of the circuit it is installed on.

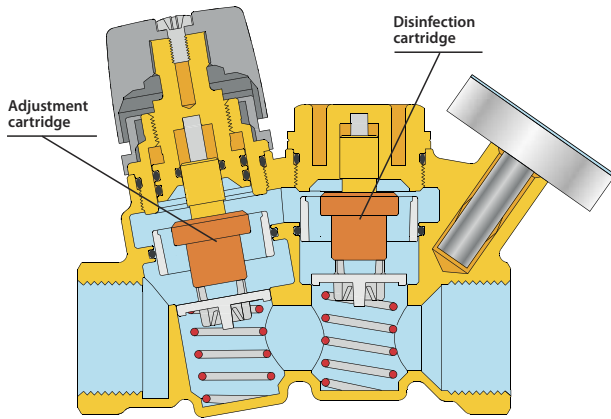
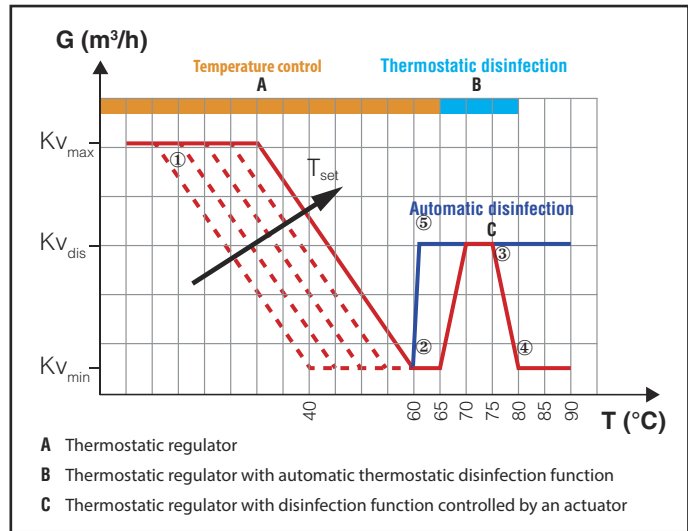

Diagram of thermostatic regulator 116 series



Thermostatic adjustment

Minimum flow rate

Thermostatic disinfection

Thermal closing

Electrically controlled disinfection

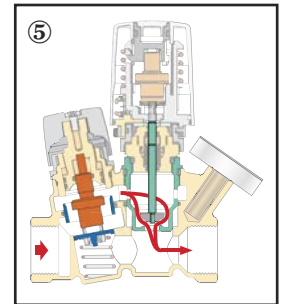
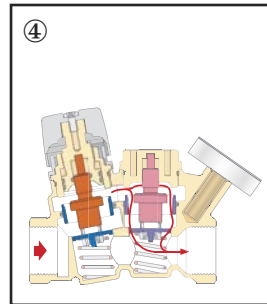
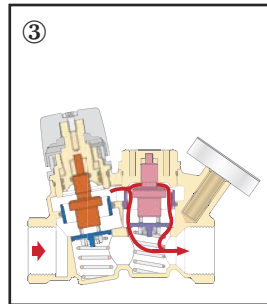
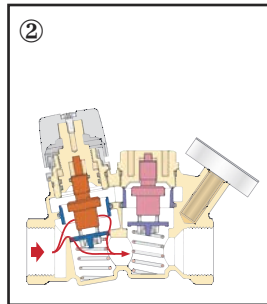
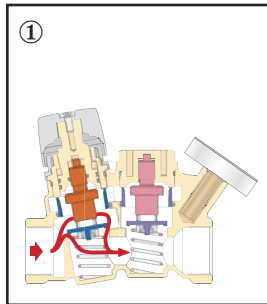

116
Thermostatic regulator for domestic hot water recirculation circuits. Complete with automatic thermostatic thermal disinfection function. With temperature gauge for circuit temperature check. **CR** dezincification resistant alloy body "LOW LEAD". Female connections. Max. working pressure: 16 bar. Adjustment temperature range: 35–60°C. Disinfection temperature: 70°C.

NEW



116
Thermostatic regulator for domestic hot water recirculation circuits. Fitted for automatic or controlled thermal disinfection function. With temperature gauge. **CR** dezincification resistant alloy body "LOW LEAD". Female connections. Max. working pressure: 16 bar. Adjustment temperature range: 35–60°C.



ATS 5200.468
C of C 040195



ATS 5200.468
C of C 040195

Code	DN	Conn.		
116240 AUS	15	1/2"	1	–
116250 AUS	20	3/4"	1	–

Code	DN	Conn.		
116141 AUS	15	1/2"	1	–
116151 AUS	20	3/4"	1	–
116140 AUS	15	1/2" without temperature gauge	1	–
116150 AUS	20	3/4" without temperature gauge	1	–



5370

tech. broch. 01028

Housing for strainer cartridges of standard nominal size 10". Brass body, transparent plastic housing. Max. working pressure: 16 bar. Temperature range: 5–40°C.

Code

537050	3/4"	1	–
537060	1"	1	–



5370

tech. broch. 01028

Strainer cartridges for housing 5370 series. Standard nominal size 10". Temperature range: 5–40°C. Max. Δp: 3 bar. Characteristics: 537004 - nylon washable mesh - 60 μm, 537005 - stainless steel mesh - 50 μm.

Code

537004		1	–
537005		1	–

WATER HAMMER ARRESTERS



525 ANTISHOCK

tech. broch. 01020

Water hammer arrester. Brass body. Chrome plated. Max. working pressure: 10 bar. Max. working temperature: 90°C. PTFE seal on thread.



Code

525040*	1/2"	1	25
525041**	1/2" yellow brass body	1	25

* Certified WRAS only
** Certified ACS only



525 ANTISHOCK

tech. broch. 01020

Water hammer arrester for fitting under sinks, wash-hand basins and washing machine (3/4"). Brass body. Chrome plated. Max. working pressure: 10 bar. Max. working temperature: 90°C.



Code

525130*	3/8" F nut x 3/8" M	1	50
525131**	3/8" F nut x 3/8" M yellow brass body	1	50
525150*	3/4" F nut x 3/4" M	1	25
525151**	3/4" F nut x 3/4" M yellow brass body	1	25

* Certified WRAS only
** Certified ACS only

Installation diagrams of water hammer arrester 525 series

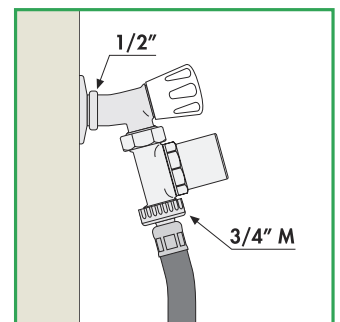
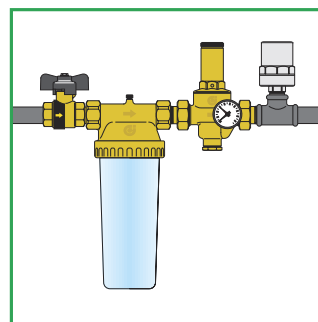
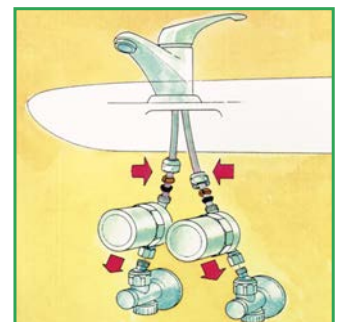
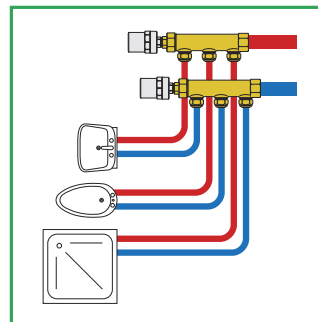



309

tech. broch. 01130

Temperature and pressure relief valve.
CR dezincification resistant alloy body.
**For domestic water system,
 to protect the hot water storage.**
 Setting temperature: 90°C.
 Discharge rating: 1/2" - 3/4" x Ø 15: 10 kW.
 3/4" x Ø 22: 25 kW.
 Settings: 3 - 4 - 6 - 7 - 10 bar.
Settings certified to EN 1490: 4 - 7 - 10 bar.



Code			Probe length (mm)		
309430	1/2" M x Ø 15	3 bar	100	1	20
309440	1/2" M x Ø 15	4 bar	100	1	20
309460	1/2" M x Ø 15	6 bar	100	1	20
309470	1/2" M x Ø 15	7 bar	100	1	20
309400	1/2" M x Ø 15	10 bar	100	1	20
309542	3/4" M x Ø 15	4 bar	100	1	20
309530	3/4" M x Ø 22	3 bar	100	1	20
309560	3/4" M x Ø 22	6 bar	100	1	20
309570	3/4" M x Ø 22	7 bar	100	1	20
309500	3/4" M x Ø 22	10 bar	100	1	20
309435	1/2" M x Ø 15	3 bar	200	1	20
309445	1/2" M x Ø 15	4 bar	200	1	20
309465	1/2" M x Ø 15	6 bar	200	1	20
309475	1/2" M x Ø 15	7 bar	200	1	20
309405	1/2" M x Ø 15	10 bar	200	1	20
309547	3/4" M x Ø 15	4 bar	200	1	20
309535	3/4" M x Ø 22	3 bar	200	1	20
309565	3/4" M x Ø 22	6 bar	200	1	20
309575	3/4" M x Ø 22	7 bar	200	1	20
309505	3/4" M x Ø 22	10 bar	200	1	20

309



Temperature and pressure relief valve.
CR dezincification resistant alloy body.
**For domestic water system,
 to protect the hot water storage.**
 Set temperature: 95°C.
 Discharge rating: 25 kW.
 Setting: 6 bar.
For systems with nominal pressure of 400 kPa.



Code		Probe length (mm)		
309563	3/4" M x Ø 22	100	1	20



5557



tech. broch. 01079

Welded expansion vessel,
 for hot water systems, EC certification.
 Bladder membrane.
 Max. working pressure: 10 bar.
 System working temperature range: -10-100°C.
 Membrane working temperature range: -10-100°C.
 Conformity to EN 13831 standard.



Code	Litres	Conn.	Precharge (bar)		
555702	2	1/2"	2,5	4	-
555705	5	3/4"	2,5	1	-
555708	8	3/4"	2,5	1	-

For bigger capacity see page 212



534

Flow limiter.
 Brass body.
 Chrome plated.
 1/2" connection.
 Max. working pressure: 12 bar.
 Max. working temperature: 80°C.
 Pressure range: 1-10 bar.

● Key to code

- flow direction M → F = 1
- flow direction F → M = 2

Code		Accuracy (%)		
534.02	2 l/min olive green	±30	1	25
534.04	4 l/min grey	±15	1	25
534.05	5 l/min yellow	±15	1	25
534.06	6 l/min black	±10	1	25
534.08	8 l/min white	±10	1	25
534.10	10 l/min light blue	±10	1	25
534.12	12 l/min red	±10	1	25
534.16	16 l/min blue	±10	1	25
534.18	18 l/min purple	±10	1	25

EXPANSION GROUPS FOR HOT WATER STORAGE HEATERS

528



Expansion group for hot water storage heaters, for horizontal or vertical installation. Brass body and expansion relief valve. With shut-off valve and controllable check valve. Max. working pressure: 10 bar. Max. working temperature: 40°C. Settings: 7, 8, 10 bar. **Certified to EN 1488.**



Code

528518	Ø 15	8 bar	1	20
528547	1/2"	7 bar	1	20
528548	1/2"	8 bar	1	20
528540	1/2"	10 bar	1	20

Application diagram 528 series

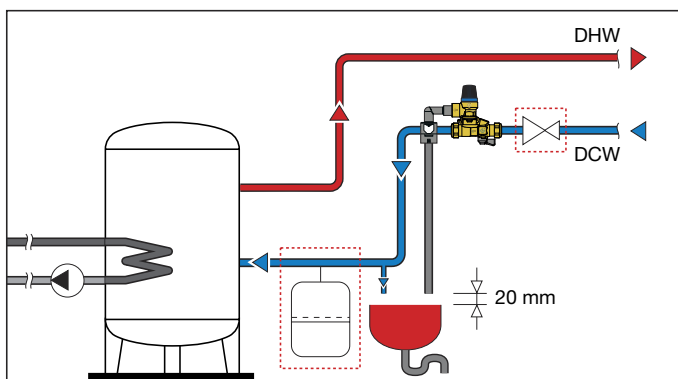
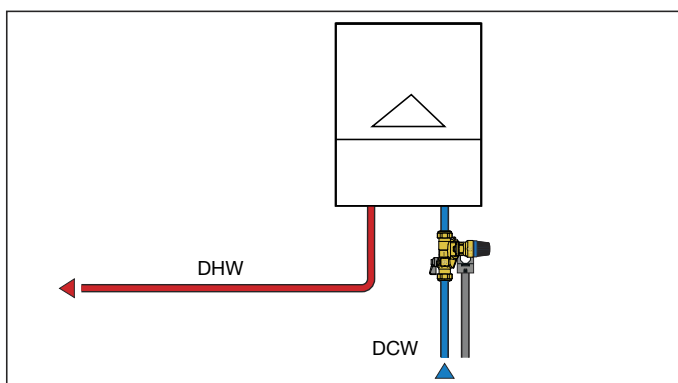
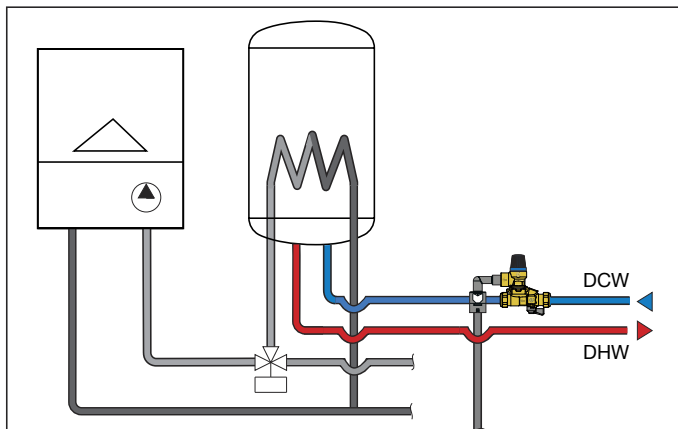

5280 SICAL®

Expansion group for hot water storage heaters, for horizontal or vertical installation. Brass body and expansion relief valve. With shut-off cock and controllable check valve. With insulation. Max. working pressure: 10 bar. Max. working temperature: 40°C. Max. volume of domestic water storage: 200 l. Max. power of domestic water storage: 75 kW. Settings: 6, 8, 10 bar. **Certified to EN 1488.**

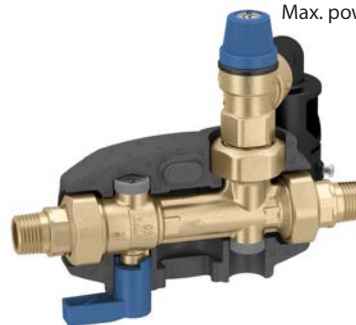

Code

Code	Expansion relief valve		
528046	1/2" M 6 bar	1	5
528048	1/2" M 8 bar	1	5
528041	1/2" M 10 bar	1	5
528056	3/4" M 6 bar	1	5
528058	3/4" M 8 bar	1	5
528051	3/4" M 10 bar	1	5

5281 SICAL®

Expansion group for hot water storage heaters, for horizontal or vertical installation. Brass body and expansion relief valve. With shut-off cock and controllable check valve. With insulation. Max. working pressure: 10 bar. Max. working temperature: 40°C. Max. volume of domestic water storage: 1000 l. Max. power of domestic water storage: 150 kW. Settings: 6, 8, 10 bar. **Certified to EN 1488.**



Code

Code	Expansion relief valve		
528156	3/4" M 6 bar	1	5
528158	3/4" M 8 bar	1	5
528151	3/4" M 10 bar	1	5
528166	1" M 6 bar	1	5
528168	1" M 8 bar	1	5
528161	1" M 10 bar	1	5

HYDRAULIC SAFETY GROUPS FOR HOT WATER STORAGE HEATERS



5261 *tech. broch. 01019*
 Hydraulic safety group for hot water storage heaters, with shut-off valve and controllable check valve.
With stainless steel seat.
 Brass body. Chrome plated.
 Max. working pressure: 10 bar.
 Max. working temperature: 120°C.
 Setting: 7 bar.
 Max. power rating: 1/2" - 4 kW,
 3/4" - 10 kW.
Certified to EN 1487.



Code			
526142	1/2"	1	30
526152	3/4"	1	30



5261 *tech. broch. 01019*
 Hydraulic safety group for hot water storage heaters, with shut-off valve and controllable check valve.
 For horizontal installation.
 Brass body. Chrome plated.
 Max. working pressure: 10 bar.
 Max. working temperature: 120°C.
 Setting: 7 bar.
 Max. power rating: 3/4" - 10 kW.
Certified to EN 1487.



Code			
526151	3/4"	1	10



5261 *tech. broch. 01019*
 Hydraulic safety group for hot water storage heaters, with shut-off valve and controllable check valve.
 Brass body. Chrome plated.
 Max. working pressure: 10 bar.
 Max. working temperature: 120°C.
 Setting: 7 bar.
 Max. power rating: 1/2" - 4 kW,
 3/4" - 10 kW.
Certified to EN 1487.



Code			
526140	1/2"	1	30
526150	3/4"	1	30



319 *tech. broch. 01019*
 Plastic discharge tundish for safety groups 5261 series.



Code			
319601	1"	1	25

Application diagram of safety group 5261 series

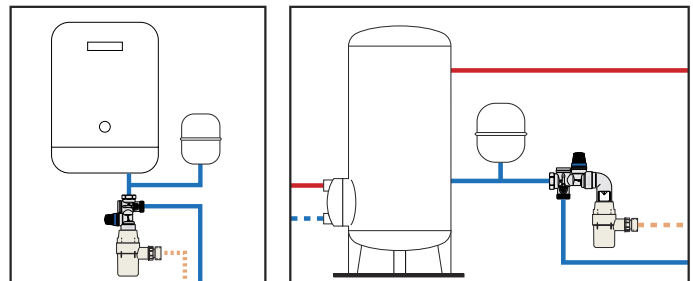

5261 *tech. broch. 01019*
 Hydraulic safety group for hot water storage heaters, with shut-off valve and controllable check valve.
 For horizontal installation.
With stainless steel seat.
 Brass body. Chrome plated.
 Max. working pressure: 10 bar.
 Max. working temperature: 120°C.
 Setting: 7 bar.
 Max. power rating: 3/4" - 10 kW,
 1" - 18 kW.
Certified to EN 1487.



Code			
526153	3/4"	1	10
526163	1" yellow brass body	1	10



6509
 Connection kit for unit code 526163.

Code			
650972	1"	1	25

Application diagram of kit code 650972 with unit code 526163

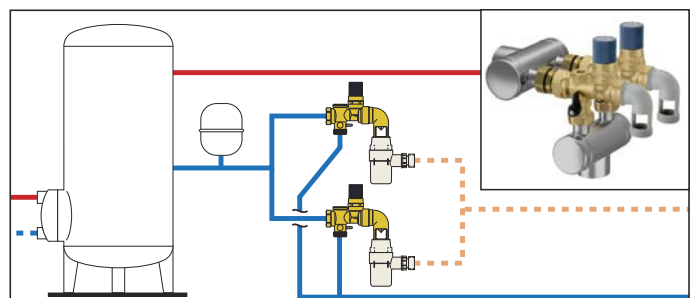

PRE-ASSEMBLED DISTRIBUTION MANIFOLDS

360

Domestic water distribution manifolds pre-assembled in inspection wall box.

CR dezincification resistant alloy body.

Max. working pressure: 10 bar.

Temperature range: 5–100°C.

Outlet centre distance: 35 mm.

Consisting of:

- pair of manifolds 354 series;
- pair of stainless steel mounting brackets, code 360210;
- inspection wall box code 360032 (320 x 250 x 90), with cover.

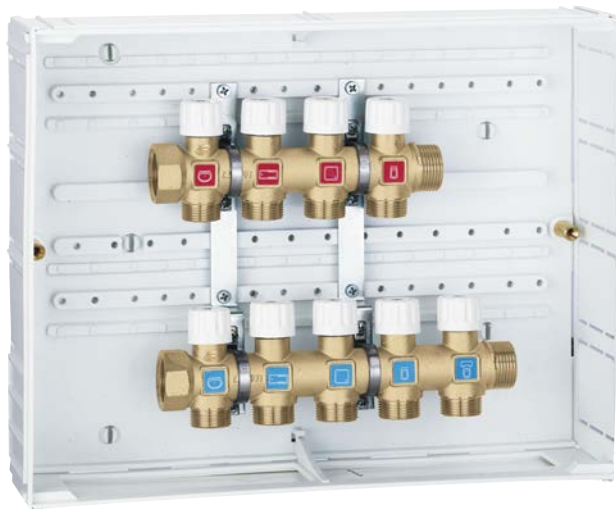

Code	Connections	Outlets No. cold hot	Outlets		
360043	3/4"	4 3	23 p.1,5 M	1	-
360054	3/4"	5 4	23 p.1,5 M	1	-



354

Modular single distribution manifold with shut-off valve.

CR dezincification resistant alloy body.

Max. working pressure: 10 bar.

Temperature range: 5–100°C.

Outlet centre distance: 35 mm.



Code	Connections	Outlets No.	Outlets		
354052	3/4"	x 2	23 p.1,5 M	5	20
354053	3/4"	x 3	23 p.1,5 M	5	20
354054	3/4"	x 4	23 p.1,5 M	5	20
354055	3/4"	x 5	23 p.1,5 M	5	20



360

Pair of stainless steel mounting brackets for modular single distribution manifolds 354 series. For inspection box 360 and 362 series.

Code		
360210	1	10



3642

End fitting.

For distribution manifolds 360 series.

Code	Connections		
364254	3/4" M x 1/2" F	2	-



3641

Plug.

For distribution manifolds 360 series.

Code	Connections		
364150	3/4" M	2	-



5991

End fitting.

For distribution manifolds 360 series.

Code	Connections		
599154	3/4" F x 1/2" F	2	-



5993

Plug.

For distribution manifolds 360 series.

Code	Connections		
599350	3/4" F	2	10

Example of distribution composition

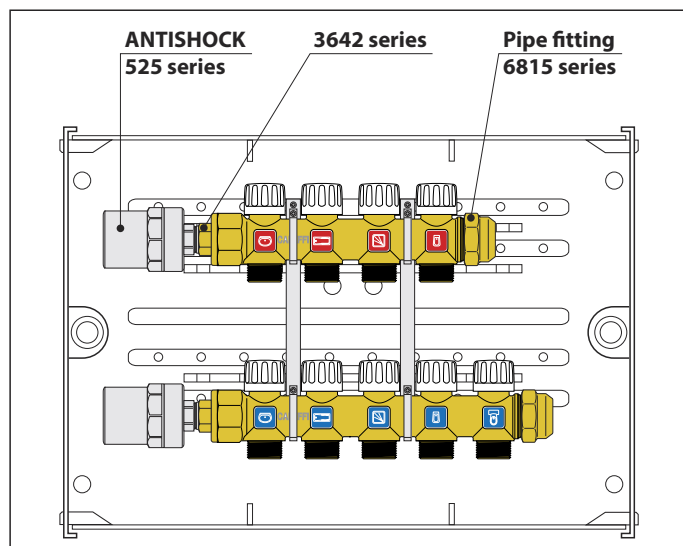

ANTI-FREEZE SAFETY DEVICE

603
ICECAL®

tech. broch. 01181



Garden tap, ball type, **with anti-freeze safety device.**
Brass body. Chrome plated.
Stainless steel lever and fixing nut.
Hose connection for Ø 15 mm pipe.
Max. working pressure: 10 bar.
Ambient temperature range: -30–90°C.
Opening temperature: 3°C.
Closing temperature: 4°C.

Code

603450 1/2" M x 3/4" M with hose connection



1 10



Anti-freeze group spare part, chrome plated for code 603450.

Code

F89046/C



1 -

Anti-freeze safety device replacement

The anti-freeze safety device is preassembled and can be replaced in case of necessity. A specific internal valve automatically shuts the water off during the replacement operation.

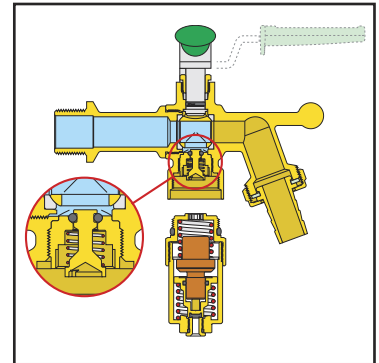

Function

The anti-freeze safety device prevents ice build-up in domestic water circuits, avoiding possible damage to pipes in hydraulic and irrigation systems. When the minimum intervention temperature is reached, it automatically opens so that a minimum quantity of water may flow toward the drain, enabling a small continuous inflow of water; this prevents the circuit from freezing.

A particular product has been developed by combining the anti-freeze safety device with a garden tap ball type, specifically constructed for these installations. The valve is fitted with ball with blow-out proof design, O-ring seal and packing gland; the control lever and fixing nut are made of stainless steel, for total resistance against corrosion in different climatic conditions.

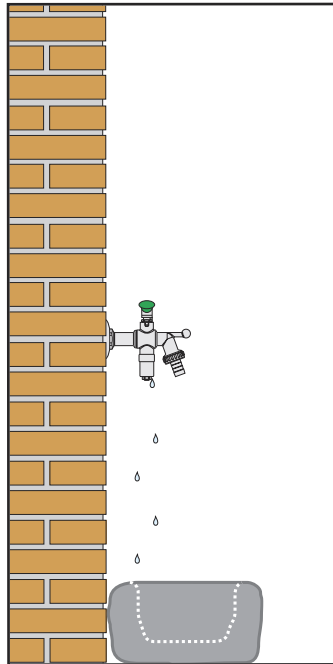

Anti-freeze safety device closed

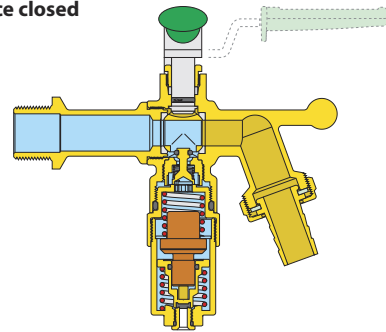

Anti-freeze safety device open

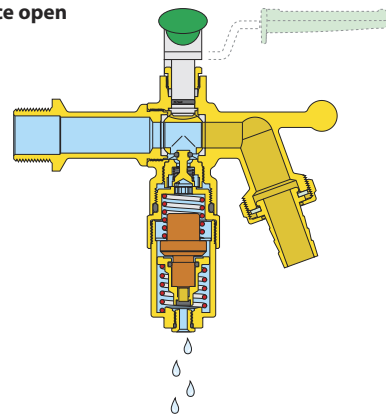

BACKFLOW PREVENTION DEVICES

This diagram is just an indication

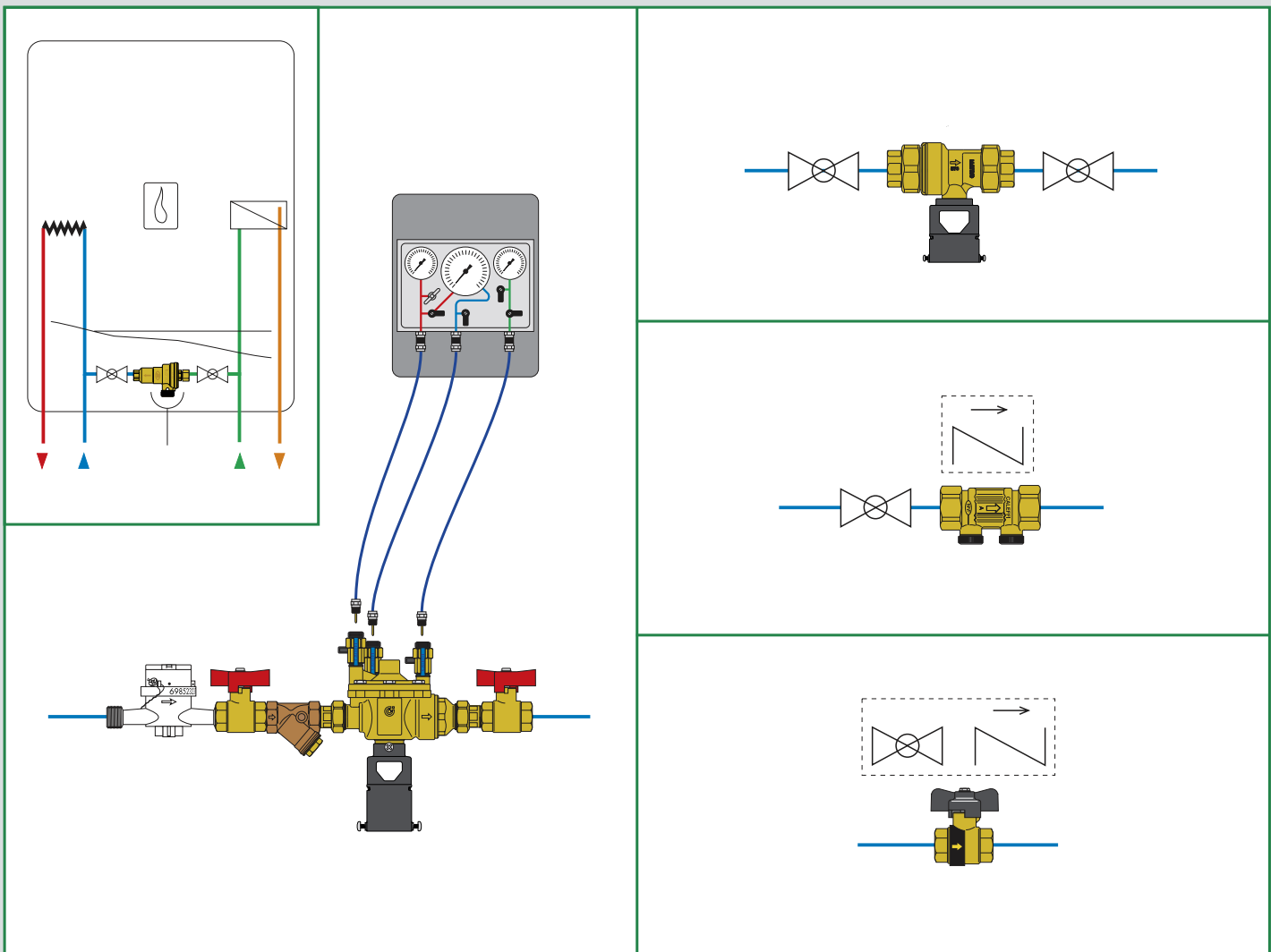

Backflow preventers

Pre-assembled group with backflow preventer, Y-strainers and shut-off valves

Y-strainers and test kit for backflow preventers

Spare parts for backflow preventers

Backflow preventers with multifunction geometry

Anti-pollution check valves with built-in shut-off valve

Ball valves with built-in check valves, BALLSTOP - Single and double check valves

Anti-pollution check valves

BACKFLOW PREVENTERS



572

Non controllable backflow preventer with different pressure zones for wall mounted boilers.
CAb type. Brass body. PN 10.
 Ø 6 copper pipe connections.
 Max. working temperature: 40°C.
To standard EN 14367.



Code			
572106		1	50



573

tech. broch. 01328

Non controllable backflow preventer with different pressure zones. **CAa type.**
 Brass body. PN 10.
 Female union connections.
 Max. working temperature: 65°C.
To standard EN 14367.



Code			
573415	1/2"	1	10
573515	3/4"	1	10



573

tech. broch. 01008

Non controllable backflow preventer with different pressure zones. **CAa type.**
CR dezincification resistant alloy body. PN 10.
 Female union connections.
 Max. working temperature: 65°C.
To standard EN 14367.



Code			
573400	1/2"	1	10
573500	3/4"	1	10



574

tech. broch. 01022

Controllable, reduced pressure zone backflow preventer.
BA type. **CR** dezincification resistant alloy body "**LOW LEAD**".
 PN 10. Male union connections.
 Max. working temperature: 65°C.
 Discharge opening differential pressure to: 14 kPa.
To standard EN 12729.
Upstream of the backflow preventer is mandatory to install a strainer 577 series.



Code			
574004	1/2"	1	10



573

Non controllable backflow preventer with different pressure zones.
 Normally closed.
 Brass body. PN 10.
 Female union connections.
 Max. working temperature: 65°C.

Code			
573404	1/2"	1	20
573504	3/4"	1	20



574

tech. broch. 01022

Controllable, reduced pressure zone backflow preventer.
BA type. **CR** dezincification resistant alloy body. "**LOW LEAD**".
 PN 10. Male union connections.
 Max. working temperature: 65°C.
 Discharge opening differential pressure to: 14 kPa.
To standard EN 12729.
Upstream of the backflow preventer is mandatory to install a strainer 577 series.

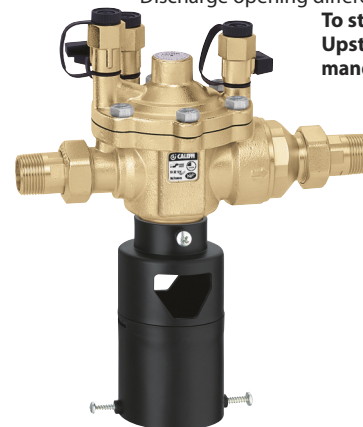

Code			
574040	1/2"	1	-
574050	3/4"	1	-
574006	1"	1	-

BACKFLOW PREVENTERS



574

tech. broch. 01022

Controllable, reduced pressure zone backflow preventer.
BA type. CR dezincification resistant alloy body "LOW LEAD".
 PN 10. Male union connections.
 Max. working temperature: 65°C.
 Discharge opening differential pressure to: 14 kPa.
To standard EN 12729.
Upstream of the backflow preventer is mandatory to install a strainer 577 series.



Code			
574600	1"	1	-
574700	1 1/4"	1	-

575

tech. broch. 01022

Controllable, reduced pressure zone backflow preventer.
BA type. Bronze body. PN 10. Flanged connections PN 16.
 To be coupled with flat counterflanges EN 1092-1.
 Max. working temperature: 65°C.
 Discharge opening differential pressure to: 14 kPa.
To standard EN 12729.
Upstream of the backflow preventer is mandatory to install a strainer 579 series.



Code			
575005	DN 50	1	-
575006	DN 65	1	-
575008	DN 80	1	-
575010	DN 100	1	-

574

tech. broch. 01022

Controllable, reduced pressure zone backflow preventer.
BA type. Bronze body. PN 10. Male union connections.
 Max. working temperature: 65°C.
 Discharge opening differential pressure to: 14 kPa.
To standard EN 12729.
Upstream of the backflow preventer is mandatory to install a strainer 577 series.



Code			
574800	1 1/2"	1	-
574900	2"	1	-

570

tech. broch. 01022

Pre-assembled group consisting of:
 backflow preventer 574 series;
 Y-strainer 577 series for backflow preventers;
 manual shut-off valves.
 PN 10. Female connections.
 Max. working temperature: 65°C.



Code			
570004	1/2"	1	-
570005	3/4"	1	-
570006	1"	1	-
570007	1 1/4"	1	-
570008	1 1/2"	1	-
570009	2"	1	-

BACKFLOW PREVENTERS

570

tech. broch. 01022

Pre-assembled group consisting of: backflow preventer 575 series; Y-strainer 579 series for backflow preventers; manual shut-off valves. PN 10. Flanged connections PN 16. To be coupled with flat counterflanges EN 1092-1. Max. working temperature: 65°C.



Code				
570050	DN 50	1	–	
570060	DN 65	1	–	
570080	DN 80	1	–	
570100	DN 100	1	–	

575

tech. broch. 01245

Controllable, reduced pressure zone backflow preventer. **BA type.** Cast iron body, with epoxy coating. PN 10. Flanged connections. To be coupled with flat counterflanges EN 1092-1. Max. working temperature: 60°C. Discharge opening differential pressure to: 14 kPa. **To standard EN 12729. Upstream of the backflow preventer is mandatory to install a strainer 579 series.**



Code				
575150	DN 150	1	–	
575200	DN 200	1	–	
575250	DN 250	1	–	

570

tech. broch. 01245

Pre-assembled group consisting of: backflow preventer 575 series; Y-strainer 579 series for backflow preventers; manual shut-off valves. PN 10. Flanged connections PN 16. To be coupled with flat counterflanges EN 1092-1. Max. working temperature: 60°C.



Code				
570150	DN 150	1	–	
570200	DN 200	1	–	
570250	DN 250	1	–	

Y-STRAINERS AND TEST KIT FOR BACKFLOW PREVENTERS

577

Y-strainer, for backflow preventers 573 and 574 series. Bronze body, 1/2"–2": PN 16, 2 1/2"–3": PN 10. Female connections. Temperature range: -20–110°C. Max. percentage of glycol: 30%. Strainer in stainless steel stretched plate.



Code	Mesh size Ø (mm)	Kv (m³/h)		
577004	1/2"	0,40	3,4	1 –
577005	3/4"	0,40	7	1 –
577006	1"	0,40	10	1 –
577007	1 1/4"	0,47	16	1 –
577008	1 1/2"	0,47	24	1 –
577009	2"	0,53	35	1 –
577020	2 1/2"	0,53	57	1 –
577030	3"	0,53	73	1 –

579

Y-strainer, for backflow preventer 575 series and for pressure reducing valve 576 series. Cast iron body, with epoxy coating. Flanged connections PN 16. To be coupled with flat counterflanges EN 1092-1. Max. working pressure: 16 bar. Max. working temperature: 65°C. Stainless steel mesh. With drain cock.



Code	Mesh size Ø (mm)	Kv (m³/h)		
579050	DN 50	0,87	54	1 –
579060	DN 65	0,87	76	1 –
579080	DN 80	1,55	108	1 –
579100	DN 100	1,55	170	1 –
579120	DN 125	1,55	295	1 –
579150	DN 150	1,55 *	408	1 –
579200	DN 200	1,55 *	725	1 –
579250	DN 250	1,55 *	938	1 –

* Rhomboidal reinforcing mesh

5750

tech. broch. 01022

Backflow preventer test kit consisting of: – upstream pressure gauge – downstream pressure gauge – differential pressure gauge – flexible hoses and connectors.



Code				
575000		1	–	

SPARE PARTS FOR BACKFLOW PREVENTERS



Discharge device for backflow preventers 574 and 575 series.

Code			
59978	1/2" (574004)	1	-
59471	1/2" (574040) - 3/4" - 1" (574006)	1	-
59457	1" (574600) - 1 1/4"	1	-
59461	1 1/2" - 2" - DN 50	1	-



Discharge device for backflow preventer 575 series.

Code			
59625	DN 65 (575006)	1	-
59629	DN 80 (575008) - DN 100 (575010)	1	-



Discharge valve seat for backflow preventers 574 and 575 series.

Code			
59472	1/2" (574040) - 3/4" - 1" (574006)	1	-
59458	1" (574600) - 1 1/4"	1	-
59462	1 1/2" - 2" - DN 50 - DN 65	1	-



Discharge valve seat for backflow preventer 575 series.

Code			
59630	DN 80 (575008) - DN 100 (575010)	1	-

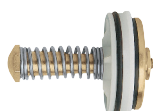

Upstream check valve for backflow preventers 574 and 575 series.

Code			
59977	1/2" (574004)	1	-
59973	1/2" (574040) - 3/4" (574050)	1	-
59469	3/4" (574005) - 1" (574006)	1	-
59455	1" (574600) - 1 1/4"	1	-
59459	1 1/2" - 2" - DN 50	1	-

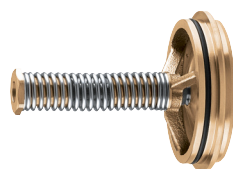

Upstream check valve for backflow preventer 575 series.

Code			
59627	DN 65 (575006)	1	-
59631	DN 80 (575008) - DN 100 (575010)	1	-



Downstream check valve for backflow preventers 574 and 575 series.

Code			
59979	1/2" (574004)	1	-
59470	1/2" (574040) - 3/4" - 1" (574006)	1	-
59456	1" (574600) - 1 1/4"	1	-
59460	1 1/2" - 2" - DN 50	1	-

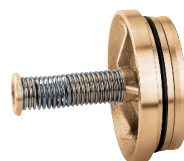

Downstream check valve for backflow preventer 575 series.

Code			
59628	DN 65 (575006)	1	-
59632	DN 80 (575008) - DN 100 (575010)	1	-

BACKFLOW PREVENTERS WITH MULTIFUNCTION GEOMETRY



580

tech. broch. 01322

Backflow preventer with multifunction geometry. **BA type.** CR dezincification resistant alloy body. Threaded union connections. For linear installation on horizontal or vertical pipes. Complete with strainer at the inlet. Max. working pressure: 10 bar. Max. working temperature: 65°C. **Certified to EN 12729 standard.**



Code				
580040	DN 15	1/2" M	1	5
580050	DN 20	3/4" M	1	5

Discharge tundish

Thanks to the possibility of orienting the tundish, the same body can be used in three different configurations: installation on horizontal or vertical pipes or for special applications.

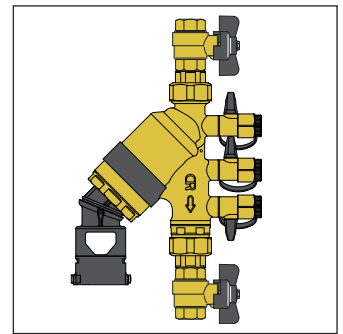
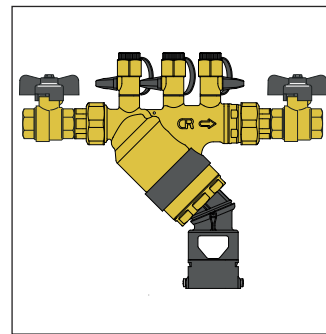

580

tech. broch. 01322

Backflow preventer with multifunction geometry. **BA type.** CR dezincification resistant alloy body. Complete with connection fitting to the tap at the inlet and hose connection at the outlet. For vertical installation. Complete with strainer at the inlet. Max. working pressure: 10 bar. Max. working temperature: 65°C. **Certified to EN 12729 and Beschluss 4/2007 standard.**



Code				
580150	DN 20	3/4" nut x 3/4" M	1	5

Self-contained cartridge

The self-contained cartridge comprises, all in one piece, the membrane, the upstream check valve, the discharge valve and the whole activation system. In case of maintenance, it can be easily extracted from the body without the aid of further sealing elements.

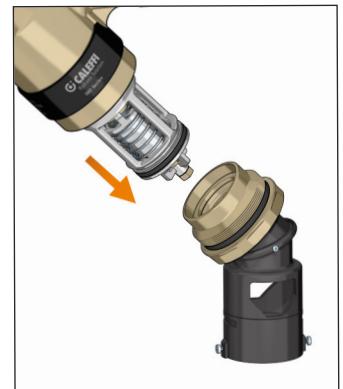

580

tech. broch. 01322

Backflow preventer with multifunction geometry. **BA type.** CR dezincification resistant alloy body. Complete with isolating valve at the inlet and hose connection at the outlet. For vertical installation. Complete with strainer at the inlet. Max. working pressure: 10 bar. Max. working temperature: 65°C. **Certified to EN 12729 and W570-3 standard.**



Code				
580240	DN 15	1/2" M x 3/4" M	1	5
580250	DN 20	3/4" M x 3/4" M	1	5

Application diagram code 580150

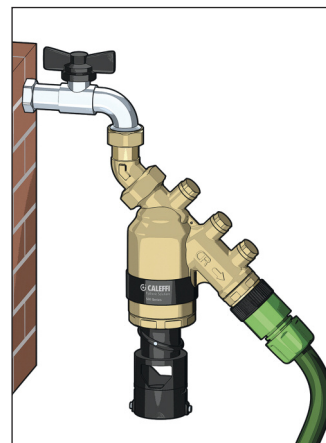

Application diagram code 580240/580250

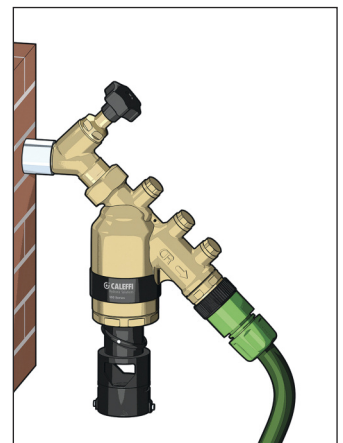

ANTI-POLLUTION CHECK VALVES WITH BUILT-IN SHUT-OFF VALVE

NEW



324

tech. broch. 01341

Anti-pollution check valve with built-in shut-off valve. **EA type**. Pressure test ports upstream and downstream. Replaceable check valve cartridge. **CR** dezincification resistant alloy body **"LOW LEAD"**. Medium: drinking water. Max. working pressure: 10 bar. Check valve minimum opening pressure (Δp): 0,5 kPa. Max. working temperature: 65°C. **To EN 13959 and EN 13828 standards.** PATENT PENDING.

kiwa

Code	DN internal check valve	Conn.		
324140	20	1/2" M	1	-
324150	20	3/4" M	1	-

Operating principle

The anti-pollution check valve with built-in shut-off valve is comprised of a valve body (1), a check valve (2), two test ports (3), one downstream for operation checks and one downstream for system pressure testing, a shut-off ball valve (4) with control lever (5). The check valve (2) delimits two distinct zones: one upstream or at the inlet (A), and one downstream at the outlet (B).

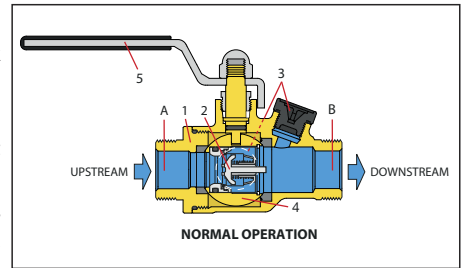

Operation check

To test the seal of the check valve, check that the valve closes each time the pressure in the upstream water supply so as to prevent water from the installation flowing back into the supply system:

- to maintain pressure in the installation in the absence of flow, close all shut-off valves and users downstream of the valve. Using the downstream test port, check that the pressure is greater than 0,5 bar;
- close the built-in shut-off valve, rotating it clockwise through 90° relative to the longitudinal position, and open the check valve test port. The flow should stop after the small amount of fluid contained in the valve body between the shut-off valve and pressure test port has drained off;
- if not, check the seal of the built-in shut-off valve: if this valve is sealing correctly but the flow from the test port continues, replace the check valve, as the flow can only be caused by imperfect sealing of the valve.



324

tech. broch. 01341

Anti-pollution check valve with built-in shut-off valve. **EA type**. Pressure test ports upstream and downstream. Replaceable check valve cartridge. **CR** dezincification resistant alloy body **"LOW LEAD"**. Medium: drinking water. Max. working pressure: 10 bar. Check valve minimum opening pressure (Δp): 0,5 kPa. Max. working temperature: 65°C. **To EN 13959 and EN 13828 standards.** PATENT PENDING.

kiwa

Code	DN internal check valve	Conn.		
324250	20	3/4" M x nut 3/4" F	1	-

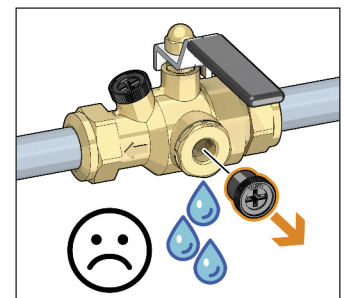
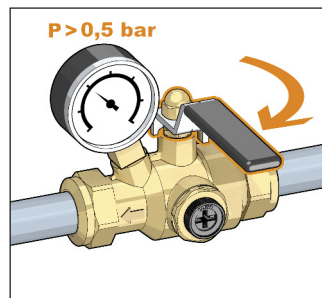

Replacement of the check valve

Thanks to the special patented design, all operation check and replacement operations can be carried out using just one shut-off valve:

- position the lever perpendicular to the valve body by raising it slightly and rotating it anti-clockwise through 90° relative to the longitudinal position;
- open the side cap;
- remove the snap ring;
- use pliers to remove the snap ring, taking care not to damage it. Carry out the maintenance operations, position the original or replacement check valve in its seat and refit by reversing the removal procedure.



324

tech. broch. 01341

Anti-pollution check valve with built-in shut-off valve. **EA type**. Pressure test ports upstream and downstream. Replaceable check valve cartridge. **CR** dezincification resistant alloy body **"LOW LEAD"**. Medium: drinking water. Max. working pressure: 10 bar. Check valve minimum opening pressure (Δp): 0,5 kPa. Max. working temperature: 65°C. **To EN 13959 and EN 13828 standards.** PATENT PENDING.

kiwa

Code	DN internal check valve	Conn.		
324110	20	Ø 15	1	-
324120	20	Ø 22	1	-

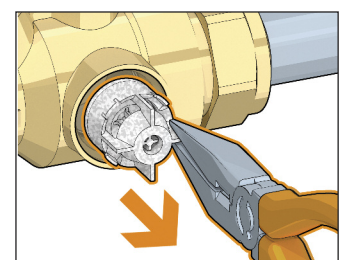
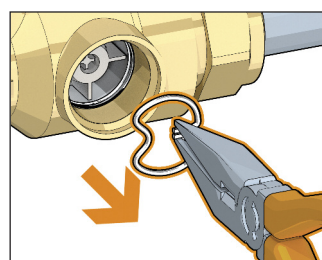
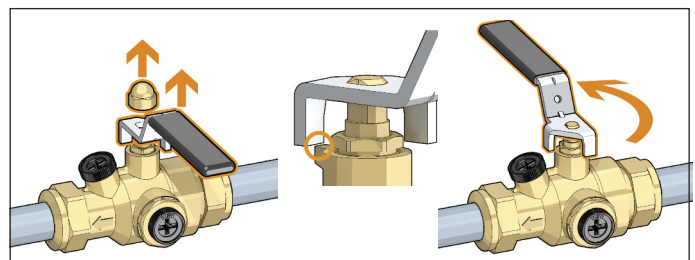

Code	DN internal check valve	Conn.		
F002665	pressure gauge 0÷10 bar		1	-

BALL VALVE WITH BUILT-IN CHECK VALVE



3230 BALLSTOP

tech. broch. 01021

Ball valve with built-in check valve.
Brass body.
Female connections.
Butterfly handle.
Max. working pressure: 16 bar.
Temperature range: 5–90°C.

kiwa approved product



Code

323040	1/2"	10	–
323050	3/4"	10	–
323060	1"	4	–



333 BALLSTOP

tech. broch. 01021

Ball valve with built-in check valve.
Brass body.
Female - nut connection.
Drilled tamper-proof safety nut.
Butterfly handle.
Max. working pressure: 16 bar.
Temperature range: 5–90°C.

kiwa approved product



Code

333400	1/2" F x nut 3/4" F	10	–
333500	3/4" F x nut 3/4" F	10	–



3230 BALLSTOP

tech. broch. 01021

Ball valve with built-in check valve.
Brass body.
Female connections.
Lever handle.
Max. working pressure: 16 bar.
Temperature range: 5–90°C.

kiwa approved product



Code

323070	1 1/4"	4	–
323080	1 1/2"	2	–
323090	2"	1	–



334 BALLSTOP

tech. broch. 01021

Ball valve with built-in check valve.
Brass body.
Male - nut connection.
Drilled tamper-proof safety nut.
Butterfly handle.
Max. working pressure: 16 bar.
Temperature range: 5–90°C.

kiwa approved product



Code

334400	1/2" M x nut 3/4" F	10	–
334500	3/4" M x nut 3/4" F	10	–



332 BALLSTOP

tech. broch. 01021

Ball valve with built-in check valve.
Brass body.
Male - female connections.
Butterfly handle.
Max. working pressure: 16 bar.
Temperature range: 5–90°C.

kiwa approved product



Code

332400	1/2" M x 1/2" F	10	–
---------------	-----------------	----	---

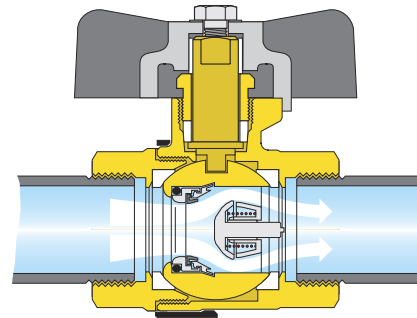

BALLSTOP
TWO VALVES
IN ONE

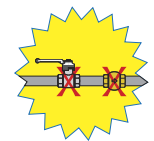

SINGLE AND DOUBLE CHECK VALVES



3037 ROBOCHECK-1

15 mm single check valve with compression ends.
CR dezincification resistant alloy body.
Chrome plated.
Max. working pressure: 10 bar.
Max. working temperature: 90°C.

WRAS APPROVED PRODUCT CERTIFICATION MARK

Code

303715	Ø 15	10	100
---------------	------	----	-----



3038 ROBOCHECK-2

15 mm controllable double check valve with compression ends.
CR dezincification resistant alloy body.
Chrome plated.
Max. working pressure: 10 bar.
Max. working temperature: 90°C.

WRAS APPROVED PRODUCT CERTIFICATION MARK

Code

303815	Ø 15	10	100
---------------	------	----	-----

ANTI-POLLUTION CHECK VALVES



3045 tech. broch. 01005
 Check valve. **EA type**.
 Controllable. Brass body.
 Female connections.
 Max. working pressure: 10 bar.
 Max. working temperature: 90°C.
To standard EN 13959.



Code	Inside check device DN	Connections		
304540	1/2"		10	100
304550	3/4"		10	50
304560	1"		5	25
304570	1 1/4"		5	25
304580	1 1/2"		2	20
304590	2"		1	10



3046
 Check valve. **EA type**.
 Controllable. Brass body.
 Nut - male connections.
 Max. working pressure: 10 bar.
 Max. working temperature: 90°C.
To standard EN 13959.



Code	Inside check device DN	Connections		
304645	15	3/4" F x 3/4" M	10	100

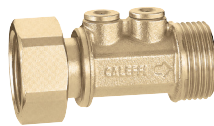

3046
 Compact check valve. **EA type**.
 Controllable. Brass body.
 Nut - male connections.
 Max. working pressure: 10 bar.
 Max. working temperature: 90°C.
To standard EN 13959.



Code	Inside check device DN	Connections		
304601	15	3/4" F x 3/4" M	10	100

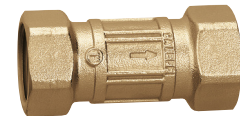

3047 tech. broch. 01005
 Check valve. **EB type**.
 Non controllable. Brass body.
 Female connections.
 Max. working pressure: 10 bar.
 Max. working temperature: 90°C.



Code	Inside check device DN	Connections		
304740	1/2"		10	100
304750	3/4"		10	50
304760	1"		5	25



3048 tech. broch. 01005
 Double check valve.
 Controllable. Brass body.
 Female connections.
 Max. working pressure: 10 bar.
 Max. working temperature: 90°C.



Code	Inside check device DN	Connections		
304840	1/2"		1	50
304850	3/4"		1	50



3046 tech. broch. 01005
 Check valve. **EA type**.
 Controllable. Brass body.
 Nut - male connections.
 Max. working pressure: 10 bar.
 Max. working temperature: 90°C.
To standard EN 13959.



Code	Inside check device DN	Connections		
304640	15	3/4" F x 3/4" M	10	100
304650	20	1" F x 1" M	10	50
304660*	25	1 1/4" F x 1 1/4" M	5	25
304670*	32	1 1/2" F x 1 1/2" M	4	20
304680*	40	2" F x 2" M	2	10

* Without NF and SVGW certification



3046
 Check valve. **EA type**.
 Controllable. Brass body.
 Nut - male connections.
 Max. working pressure: 10 bar.
 Max. working temperature: 90°C.
To standard EN 13959.



Code	Inside check device DN	Connections		
304644	15	3/4" F nut x 3/4" M	1	50
304654	20	1" F nut x 1" M	1	50



3041 tech. broch. 01005
 Ball valve with built-in certified check valve.
 Controllable. Brass body.
 Nut - male connections.
 Max. working pressure: 10 bar.
 Max. working temperature: 90°C.



Code	Inside check device DN	Connections		
304140	15	3/4" F x 3/4" M	5	25

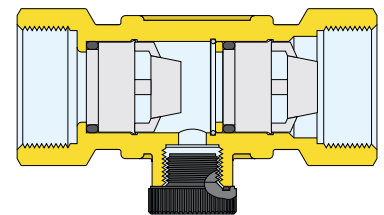

The watertightness of the check valve, furthermore, can be verified by using the pressure test port on the valve body.

BALANCING DEVICES

This diagram is just an indication

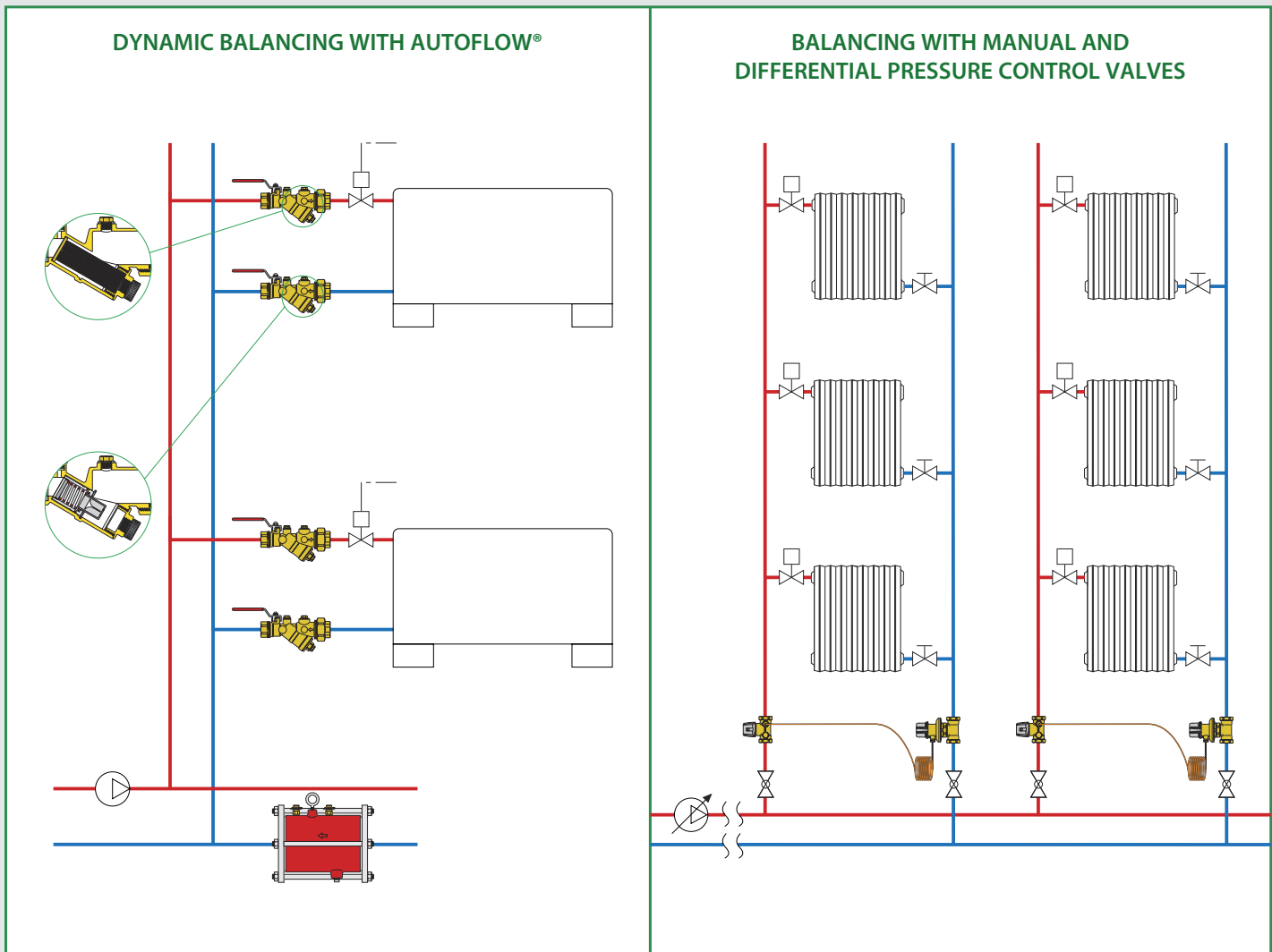

Connection and regulation kit for HVAC terminal units

Pressure independent control valve (PICV) FLOWMATIC®

Automatic flow rate regulators AUTOFLOW®

Strainers

Automatic flow rate regulator with stainless steel cartridge - flanged version AUTOFLOW®

Balancing valve with flow meter

Balancing valves

Counterflanges

Differential pressure control valve (DPCV)

Electronic flow rate and differential pressure measuring station

CIRCUITS BALANCING DEVICES

Circuit balancing devices can be classified in accordance with their method of action and the type of control they perform in relation to the hydronic circuit.

Dynamic balancing and control devices

- Connection and regulation kit for HVAC terminal units

149 series

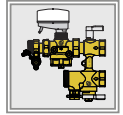
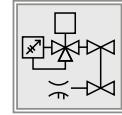

- Pressure independent control valve (PICV)

145-146 series

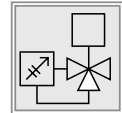

Dynamic balancing devices

- Automatic flow rate regulator, fixed flow rate

127-128-121-126-120-125-103 series

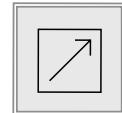

Static balancing devices

- Balancing valve with flow meter

132 series

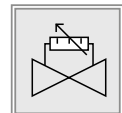

- Manual balancing valve, with Venturi device

130 series

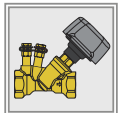
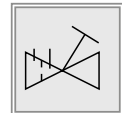

- Manual balancing valve, with variable orifice

130 series

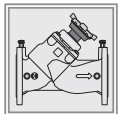
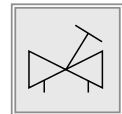

Differential pressure regulating devices

- Differential pressure regulating valve

140 series

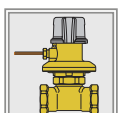
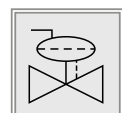

- Shut-off and pre-regulation valve

142 series

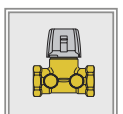
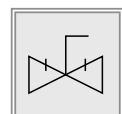

- Differential by-pass valve

519 series

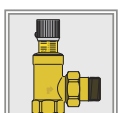
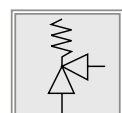

CONNECTION AND REGULATION KIT FOR HVAC TERMINAL UNITS

NEW

149

tech. broch. 01262

Connection and regulation kit for HVAC terminal units.
CR dezincification resistant alloy body.

- Complete with:
- pressure independent control valve,
 - three-way shut-off valve,
 - integrated by-pass,
 - Venturi device with pressure test ports (only in codes 149.00 ...),
 - filtering cartridge,
 - pre-formed shell insulation.



Max. working pressure: 25 bar.
Temperature range: -10–120°C.
Max. percentage of glycol: 50%.
Δp range (PICV): 25–400 kPa.
Fitted for 145 series actuator and 656. series thermo-electric actuator.

With Venturi device

Code	DN	Kv Venturi	Flow rates range (m ³ /h)		
149400 H10	15	0,25	0,02–0,10	1	–
149400 H20	15	0,50	0,10–0,20	1	–
149400 H40	15	1,10	0,20–0,40	1	–
149400 H80	15	2,35	0,40–0,80	1	–
149500 H10	20	0,25	0,02–0,10	1	–
149500 H20	20	0,50	0,10–0,20	1	–
149500 H40	20	1,10	0,20–0,40	1	–
149500 H80	20	2,35	0,40–0,80	1	–
149500 1H2	20	5,00	0,80–1,20	1	–
149600 1H8	25	5,00	1,20–1,80	1	–
149600 3H0	25	9,60	1,80–3,00	1	–

Without Venturi device

Code	DN	Flow rates range (m ³ /h)		
149410 H20	15	0,02–0,20	1	–
149410 H40	15	0,08–0,40	1	–
149410 H80	15	0,08–0,80	1	–
149510 H20	20	0,02–0,20	1	–
149510 H40	20	0,08–0,40	1	–
149510 H80	20	0,08–0,80	1	–
149510 1H2	20	0,12–1,20	1	–
149610 1H8	25	0,18–1,80	1	–
149610 3H0	25	0,30–3,00	1	–

NEW

Drain cock for 149 series.



Code			
F0000680	3/4" M x quick connection 3/4" F	1	–
F0000681	1" M x quick connection 1" F	1	–
F0000682	1 1/4" M x quick connection 1 1/4" F	1	–

145

FLOWMATIC®

tech. broch. 01262



Proportional linear actuator for control valve 145 and kit 149 series.
Supply: 24 V (ac/dc).
Ambient temperature range: 0–50°C.
Protection class: IP 43.
Connection: M30 p. 1,5.
Cable length: 1,5 m.

Code	Tension V	Control		
145014	24	0–10 V	1	–

6562

tech. broch. 01198



Thermo-electric actuator.
With opening position indicator.
Quick-coupling installation, with a clip adapter.
Normally closed.
Supply: 230 V (ac) or 24 V (ac)/(dc).
Power consumption: 3 W.
Starting current: ≤ 1 A.
Ambient temperature range: 0–50°C.
Protection class: IP 54.
Cable length: 80 cm.



Code	Supply voltage V		
656202	230	1	10
656204	24	1	10

Installation

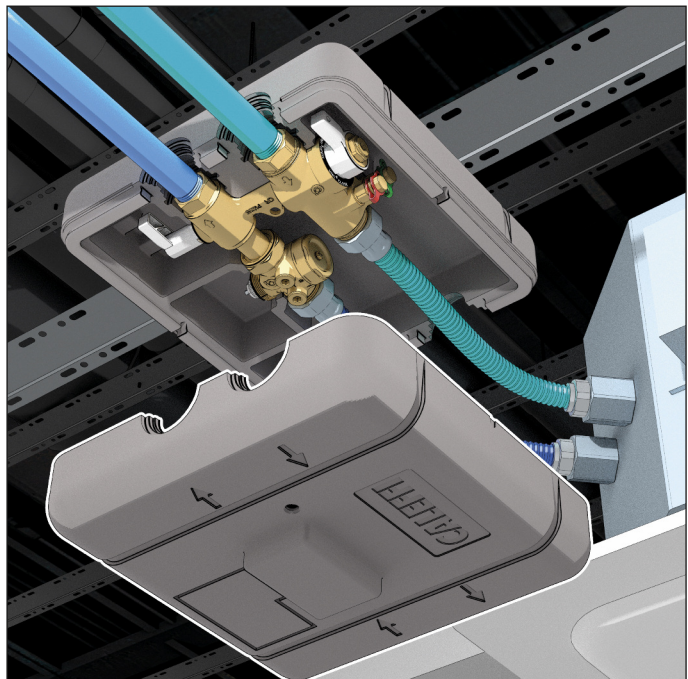

PRESSURE INDEPENDENT CONTROL VALVE (PICV)

NEW

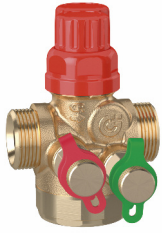

145 FLOWMATIC®

tech. broch. 01262

Pressure independent control valve FLOWMATIC®. CR dezincification resistant alloy body. Male connections. Flow rate regulator in polymer with membrane in EPDM. Graduated scale indicator. Max. working pressure: 16 bar. Temperature range: -20–120°C. Max. percentage of glycol: 50%. Δp range: 25–400 kPa. With pressure test ports. **Fitted for 145 series actuator and 656. series thermo-electric actuator.**

Code	DN	Conn.	Flow rate range (m³/h)		
145437 H20	15	1/2"	0,02–0,20	1	10
145447 H40	15	3/4"	0,08–0,40	1	10
145447 H80	15	3/4"	0,08–0,80	1	10
145557 H40	20	1"	0,08–0,40	1	10
145557 H80	20	1"	0,08–0,80	1	10
145557 1H2	20	1"	0,12–1,20	1	10
145667 1H8	25	1 1/4"	0,18–1,80	1	10
145667 3H0	25	1 1/4"	0,30–3,00	1	10

NEW



Union with gasket.

Code			
145001	1/2" F x 3/8" M	1	–
145003	3/4" F x 1/2" M	1	–
145005	1" F x 3/4" M	1	–
145006	1" F x 1" M	1	–
145007	1 1/4" F x 1" M	1	–
145008	1 1/4" F x 1 1/4" M	1	–

NEW



145 FLOWMATIC®

tech. broch. 01262

Pressure independent control valve FLOWMATIC®. CR dezincification resistant alloy body. Male connections. Flow rate regulator in polymer with membrane in EPDM. Graduated scale indicator. Max. working pressure: 16 bar. Temperature range: -20–120°C. Max. percentage of glycol: 50%. Δp range: 25–400 kPa. Fitted for connection of pressure test ports. **Fitted for 145 series actuator and 656. series thermo-electric actuator.**

Code	DN	Conn.	Flow rate range (m³/h)		
145434 H20	15	1/2"	0,02–0,20	1	10
145444 H40	15	3/4"	0,08–0,40	1	10
145444 H80	15	3/4"	0,08–0,80	1	10
145554 H40	20	1"	0,08–0,40	1	10
145554 H80	20	1"	0,08–0,80	1	10
145554 1H2	20	1"	0,12–1,20	1	10
145664 1H8	25	1 1/4"	0,18–1,80	1	10
145664 3H0	25	1 1/4"	0,30–3,00	1	10



145 FLOWMATIC®

tech. broch. 01262

Proportional linear actuator for control valve 145 and kit 149 series. Supply: 24 V (ac/dc). Ambient temperature range: 0–50°C. Protection class: IP 43. Connection: M30 p. 1,5. Cable length: 1,5 m.

Code	Tension V	Control		
145014	24	0–10 V	1	–



6561

tech. broch. 01042

Thermo-electric actuator. Normally closed. Supply: 230 V (ac) or 24 V (ac)/(dc). Power consumption: 3 W. Starting current: ≤ 1 A. Max. ambient temperature: 50°C. Protection class: IP 44 (vertical stem). Cable length: 80 cm.





Code	Supply voltage V		
656102	230	1	10
656104	24	1	10

PRESSURE INDEPENDENT CONTROL VALVE (PICV)



145



Pressure independent control valve.
Brass body.
Female connections.
Graduated scale indicator.
Max. working pressure: 25 bar.
Temperature range: -20–120°C.
Max. percentage of glycol: 50%.
Δp range: 16–400 kPa.
With pressure ports.

Code	DN	Conn.	Flow rate range (m ³ /h)		
145771	32	1 1/4"	0,86– 4,63	1	–
145881	40	1 1/2"	1,90–13,65	1	–
145991	50	2"	1,90–13,65	1	–



145

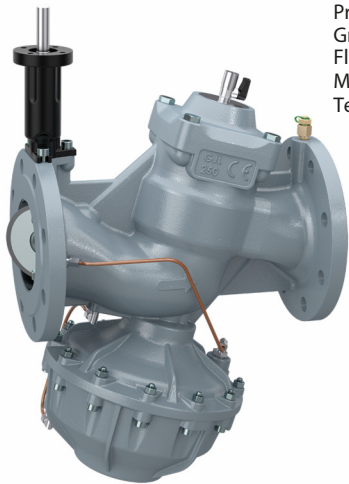

Proportional linear actuator for control valve 145 series.
Supply: 24 V (ac/dc).
Ambient temperature range: -18–50°C.
Protection class: IP 54.
Connection: M30 p. 1,5.
Length of supply cable: 1 m.

Code	Tension V	Control	Use		
145015	24	0–10 V	DN 32	1	–
145016	24	0–10 V	DN 40 - DN 50	1	–



146

Pressure independent control valve.
Grey cast iron body.
Flanged connections PN 16.
Max. working pressure: 16 bar.
Temperature range: -10–120°C.
Max. percentage of glycol: 50%.
Δp range: 30–400 kPa.
With pressure ports.
To be coupled with flat counterflanges EN 1092-2.

Code	DN	Flow rate range (m ³ /h)		
146060	65	5– 26	1	–
146080	80	6– 38	1	–
146100	100	8– 75	1	–
146120	125	14–125	1	–
146150	150	16–160	1	–

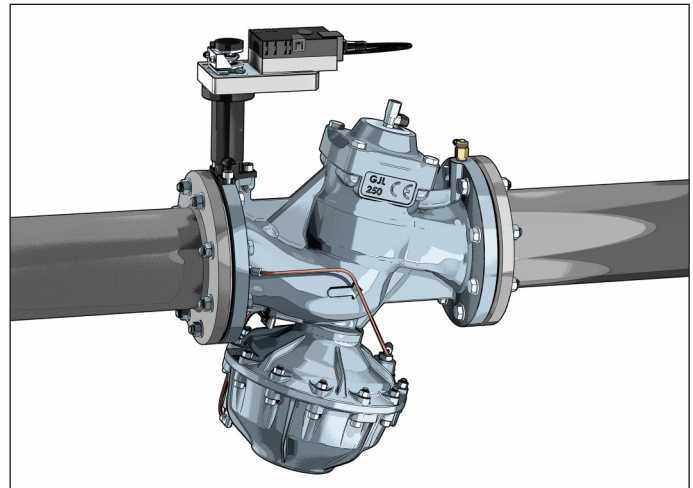

146



Manual actuator for pressure independent control valve 146 series.

Code		
146000	1	–



146

Rotational proportional actuator for regulating valve 146 series.
Supply: 24 V (ac/dc).
Ambient temperature range: -30–50°C.
Protection class: IP 54.
Manual override.

Code	Tension V	Control	Use		
146014	24	0–10 V	DN 65 - DN 80	1	–
146015	24	0–10 V	DN 100–DN 150	1	–

COMPACT AUTOMATIC FLOW RATE REGULATOR WITH HIGH RESISTANCE POLYMER CARTRIDGE



127 AUTOFLOW®

tech. broch. 01166

Compact automatic flow rate regulator.

Brass body.

AUTOFLOW® cartridge:

1/2"–11/4" in high resistance polymer,

1 1/2" – 2" in high resistance polymer and stainless steel.

Max. working pressure: 16 bar.

Temperature range: 0–100°C.

Max. percentage of glycol: 50%.

Flow rates: 0,02–0,06 m³/h - Δp range: 20–200 kPa - Accuracy: ±15%.

Flow rates: 0,085–11,0 m³/h - Δp range: 15–200 kPa - Accuracy: ±10%.



Code

127141 ●●●	1/2"	1	–
127151 ●●●	3/4"	1	–
127161 ●●●	1"	1	–
127171 ●●●	1 1/4"	1	–
127181 ●●●	1 1/2"	1	–
127191 ●●●	2"	1	–

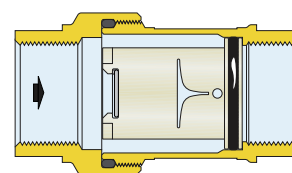

Code	Min. working Δp (kPa)	Δp range (kPa)	Flow rates (m³/h)
127141 ●●●	15	15–200 (20–200*)	0,02*; 0,04*; 0,06*; 0,085; 0,12; 0,15; 0,2; 0,25; 0,3; 0,35; 0,4; 0,5; 0,6; 0,7; 0,8; 0,9; 1,0; 1,2; 1,4
127151 ●●●	15	15–200 (20–200*)	0,02*; 0,04*; 0,06*; 0,085; 0,12; 0,15; 0,2; 0,25; 0,3; 0,35; 0,4; 0,5; 0,6; 0,7; 0,8; 0,9; 1,0; 1,2; 1,4; 1,6
127161 ●●●	15	15–200	0,5; 0,6; 0,7; 0,8; 0,9; 1,0; 1,2; 1,4; 1,6; 1,8; 2,0; 2,25; 2,5; 2,75; 3,0; 3,25; 3,5; 3,75; 4,0; 4,25; 4,5; 4,75; 5,0
127171 ●●●	15	15–200	0,5; 0,6; 0,7; 0,8; 0,9; 1,0; 1,2; 1,4; 1,6; 1,8; 2,0; 2,25; 2,5; 2,75; 3,0; 3,25; 3,5; 3,75; 4,0; 4,25; 4,5; 4,75; 5,0
127181 ●●●	15	15–200	4,5; 4,75; 5,0; 5,5; 6,0; 6,5; 7,0; 7,5; 8,0; 8,5; 9,0; 9,5; 10,0; 11,0
127191 ●●●	15	15–200	4,5; 4,75; 5,0; 5,5; 6,0; 6,5; 7,0; 7,5; 8,0; 8,5; 9,0; 9,5; 10,0; 11,0

Minimum differential pressure required

Equal to the minimum working Δp of the AUTOFLOW® cartridge (15 or 20 kPa).

$$\text{Pump head } H = \Delta p_{\text{circuit}} + \Delta p_{\text{require}}$$

Spare AUTOFLOW® polymer cartridge complete with adhesive label. For 127 series.



For 1/2" and 3/4" bodies

Code	Flow rate (m³/h)
02M02 XXG	0,02
02M04 XXG	0,04
02M06 XXG	0,06
02M08 XXG	0,085
02M12 XXG	0,12
02M15 XXG	0,15
02M20 XXG	0,20
02M25 XXG	0,25
02M30 XXG	0,30
02M35 XXG	0,35
02M40 XXG	0,40
02M50 XXG	0,50
02M60 XXG	0,60
02M70 XXG	0,70
02M80 XXG	0,80
02M90 XXG	0,90
021M0 XXG	1,00
021M2 XXG	1,20
021M4 XXG	1,40
021M6 XXG	1,60



For 1" and 1 1/4" bodies, with adapter

Code	Flow rate (m³/h)
02M50 XXH	0,50
02M60 XXH	0,60
02M70 XXH	0,70
02M80 XXH	0,80
02M90 XXH	0,90
021M0 XXH	1,00
021M2 XXH	1,20
021M4 XXH	1,40
021M6 XXH	1,60



For 1" and 1 1/4" bodies

Code	Flow rate (m³/h)
041M8 XXH	1,80
042M0 XXH	2,00
042M2 XXH	2,25
042M5 XXH	2,50
042M7 XXH	2,75
043M0 XXH	3,00
043M2 XXH	3,25
043M5 XXH	3,50
043M7 XXH	3,75
044M0 XXH	4,00
044M2 XXH	4,25
044M5 XXH	4,50
044M7 XXH	4,75
045M0 XXH	5,00



For 1 1/2" and 2" bodies, with adapter

Code	Flow rate (m³/h)
044M5 XXI	4,50
044M7 XXI	4,75
045M0 XXI	5,00



For 1 1/2" and 2" bodies

Code	Flow rate (m³/h)
055M5 XXI	5,50
056M0 XXI	6,00
056M5 XXI	6,50
057M0 XXI	7,00
057M5 XXI	7,50
058M0 XXI	8,00
058M5 XXI	8,50
059M0 XXI	9,00
059M5 XXI	9,50
0510M XXI	10,0
0511M XXI	11,0

COMPACT AUTOMATIC FLOW RATE REGULATOR WITH HIGH RESISTANCE POLYMER CARTRIDGE





128 AUTOFLOW®

tech. broch. 01269

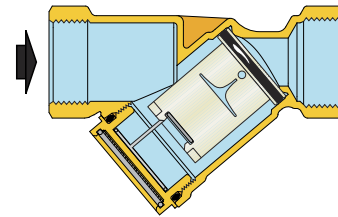
Compact automatic flow rate regulator.
 Brass body.
 AUTOFLOW® cartridge: in high resistance polymer.
 Max. working pressure: 16 bar.
 Temperature range: 0–100°C.
 Max. percentage of glycol: 50%.
 Flow rates: 0,02–0,06 m³/h - Δp range: 20–200 kPa - Accuracy: ±15%.
 Flow rates: 0,085–1,4 m³/h - Δp range: 15–200 kPa - Accuracy: ±10%.



Code			
128141 ●●●	1/2"	1	–
128151 ●●●	3/4"	1	–

Code	Kv (m³/h)	Min. working Δp (kPa)	Δp range (kPa)	Flow rates (m³/h)
128141 ●●●	6,69	15	15–200 (20–200*)	0,02*; 0,04*; 0,06*; 0,085; 0,12; 0,15; 0,2; 0,25; 0,3; 0,35; 0,4; 0,5; 0,6; 0,7; 0,8; 0,9; 1,0; 1,2
128151 ●●●	7,58	15	15–200 (20–200*)	0,02*; 0,04*; 0,06*; 0,085; 0,12; 0,15; 0,2; 0,25; 0,3; 0,35; 0,4; 0,5; 0,6; 0,7; 0,8; 0,9; 1,0; 1,2; 1,4

Minimum differential pressure required

Equal to the minimum working Δp of the AUTOFLOW® cartridge (15 or 20 kPa).
 Pump head $H = \Delta p_{\text{circuit}} + \Delta p_{\text{require}}$

Spare AUTOFLOW® polymer cartridge complete with identification metal plate.
 For 128 series.



Code	Flow rate (m³/h)	Code	Flow rate (m³/h)	Code	Flow rate (m³/h)
02M02 XXL	0,02	02M25 XXL	0,25	02M80 XXL	0,80
02M04 XXL	0,04	02M30 XXL	0,30	02M90 XXL	0,90
02M06 XXL	0,06	02M35 XXL	0,35	021M0 XXL	1,00
02M08 XXL	0,085	02M40 XXL	0,40	021M2 XXL	1,20
02M12 XXL	0,12	02M50 XXL	0,50	021M4 XXL	1,40
02M15 XXL	0,15	02M60 XXL	0,60		
02M20 XXL	0,20	02M70 XXL	0,70		

AUTOMATIC FLOW RATE REGULATOR WITH HIGH RESISTANCE POLYMER CARTRIDGE AND BALL VALVE



tech. broch. 01141

121 AUTOFLOW®

Combination of automatic flow rate regulator and ball valve.
 CRdezincification resistant alloy body.
 AUTOFLOW® cartridge:
 1/2"-11/4" in high resistance polymer,
 1 1/2" - 2" in high resistance polymer and stainless steel.
 Max. working pressure: 25 bar.
 Temperature range: -20-100°C.
 Max. percentage of glycol: 50%.
 Δp range: 15-200 kPa.
 Flow rates: 0,085-11,0 m³/h.
 Accuracy: ±10%.

Code	Size	Qv	Q	Range Δp
121141	1/2"	6,90	0,085 - 1,2	15 - 200
121151	3/4"	7,73	0,085 - 1,6	15 - 200
121161	1"	18,00	0,5 - 5,0	15 - 200
121171	1 1/4"	18,50	0,5 - 5,0	15 - 200
121181	1 1/2"	47,24	5,5 - 11,0	15 - 200
121191	2"	48,89	5,5 - 11,0	15 - 200

Fitted for connection of pressure ports and drain valve.

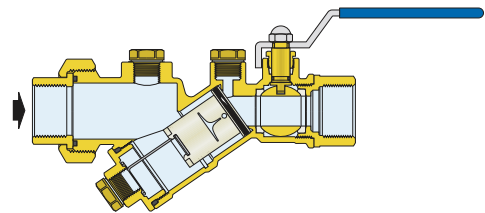

Code	Kv (m³/h)	Min. working Δp (kPa)	Δp range (kPa)	Flow rates (m³/h)
121141	6,90	15	15-200	0,085; 0,12; 0,15; 0,2; 0,25; 0,3; 0,35; 0,4; 0,5; 0,6; 0,7; 0,8; 0,9; 1,0; 1,2
121151	7,73	15	15-200	0,085; 0,12; 0,15; 0,2; 0,25; 0,3; 0,35; 0,4; 0,5; 0,6; 0,7; 0,8; 0,9; 1,0; 1,2; 1,4; 1,6
121161	18,00	15	15-200	0,5; 0,6; 0,7; 0,8; 0,9; 1,0; 1,2; 1,4; 1,6; 1,8; 2,0; 2,25; 2,5; 2,75; 3,0; 3,25; 3,5; 3,75; 4,0; 4,25; 4,5; 4,75; 5,0
121171	18,50	15	15-200	0,5; 0,6; 0,7; 0,8; 0,9; 1,0; 1,2; 1,4; 1,6; 1,8; 2,0; 2,25; 2,5; 2,75; 3,0; 3,25; 3,5; 3,75; 4,0; 4,25; 4,5; 4,75; 5,0
121181	47,24	15	15-200	5,5; 6,0; 6,5; 7,0; 7,5; 8,0; 8,5; 9,0; 9,5; 10,0; 11,0
121191	48,89	15	15-200	5,5; 6,0; 6,5; 7,0; 7,5; 8,0; 8,5; 9,0; 9,5; 10,0; 11,0

Minimum differential pressure required

This is given by the sum of two values:

1. the minimum working Δp of the AUTOFLOW® cartridge;
2. the Δp required for the nominal flow rate to pass through the valve body. This value can be determined on the basis of the values of Kv shown above referring to the valve body.

Pump head $H = \Delta p_{\text{circuit}} + \Delta p_{\text{request}}$

Spare AUTOFLOW® polymer cartridge complete with metal identification plate and metal chain for fixing to the body of the AUTOFLOW® device. For 121 and 126 series.



For 1/2" and 3/4" bodies

Code	Flow rate (m³/h)
02M08 XXX	0,085
02M12 XXX	0,12
02M15 XXX	0,15
02M20 XXX	0,20
02M25 XXX	0,25
02M30 XXX	0,30
02M35 XXX	0,35
02M40 XXX	0,40
02M50 XXX	0,50
02M60 XXX	0,60
02M70 XXX	0,70
02M80 XXX	0,80
02M90 XXX	0,90
021M0 XXX	1,00
021M2 XXX	1,20
021M4 XXX	1,40
021M6 XXX	1,60



For 1" and 1 1/4" bodies, with adapter

Code	Flow rate (m³/h)
02M50 XXC	0,50
02M60 XXC	0,60
02M70 XXC	0,70
02M80 XXC	0,80
02M90 XXC	0,90
021M0 XXC	1,00
021M2 XXC	1,20
021M4 XXC	1,40
021M6 XXC	1,60



For 1" and 1 1/4" bodies

Code	Flow rate (m³/h)
041M8 XXC	1,80
042M0 XXC	2,00
042M2 XXC	2,25
042M5 XXC	2,50
042M7 XXC	2,75
043M0 XXC	3,00
043M2 XXC	3,25
043M5 XXC	3,50
043M7 XXC	3,75
044M0 XXC	4,00
044M2 XXC	4,25
044M5 XXC	4,50
044M7 XXC	4,75
045M0 XXC	5,00



For 1 1/2" and 2" bodies

Code	Flow rate (m³/h)
055M5 XXD	5,50
056M0 XXD	6,00
056M5 XXD	6,50
057M0 XXD	7,00
057M5 XXD	7,50
058M0 XXD	8,00
058M5 XXD	8,50
059M0 XXD	9,00
059M5 XXD	9,50
0510M XXD	10,0
0511M XXD	11,0

NOTE:
When ordering, give the full code of the AUTOFLOW® device into which the cartridge is to be fitted (code shown on the metal plate supplied with every AUTOFLOW® unit).

AUTOMATIC FLOW RATE REGULATOR WITH HIGH RESISTANCE POLYMER CARTRIDGE



126 AUTOFLOW®

tech. broch. 01141

Automatic flow rate regulator.
CR dezincification resistant alloy body.
 AUTOFLOW® cartridge:
 1/2"-11/4" in high resistance polymer,
 1 1/2" - 2" in high resistance polymer and stainless steel.
 Max. working pressure: 25 bar.
 Temperature range: -20-100°C.
 Max. percentage of glycol: 50%.
 Δp range: 15-200 kPa.
 Flow rates: 0,085-11,0 m³/h.
 Accuracy: ±10%.

Fitted for connection of pressure ports and drain valve.

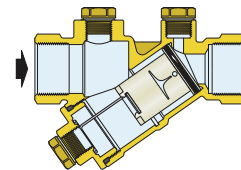

Code	Size	Flow rates (m³/h)
126141 ●●●	1/2"	1
126151 ●●●	3/4"	1
126161 ●●●	1"	1
126171 ●●●	1 1/4"	1
126181 ●●●	1 1/2"	1
126191 ●●●	2"	1

Code	Kv (m³/h)	Min. working Δp (kPa)	Δp range (kPa)	Flow rates (m³/h)
126141 ●●●	6,69	15	15-200	0,085; 0,12; 0,15; 0,2; 0,25; 0,3; 0,35; 0,4; 0,5; 0,6; 0,7; 0,8; 0,9; 1,0; 1,2
126151 ●●●	7,58	15	15-200	0,085; 0,12; 0,15; 0,2; 0,25; 0,3; 0,35; 0,4; 0,5; 0,6; 0,7; 0,8; 0,9; 1,0; 1,2; 1,4; 1,6
126161 ●●●	14,00	15	15-200	0,5; 0,6; 0,7; 0,8; 0,9; 1,0; 1,2; 1,4; 1,6; 1,8; 2,0; 2,25; 2,5; 2,75; 3,0; 3,25; 3,5; 3,75; 4,0; 4,25; 4,5; 4,75; 5,00
126171 ●●●	14,50	15	15-200	0,5; 0,6; 0,7; 0,8; 0,9; 1,0; 1,2; 1,4; 1,6; 1,8; 2,0; 2,25; 2,5; 2,75; 3,0; 3,25; 3,5; 3,75; 4,0; 4,25; 4,5; 4,75; 5,00
126181 ●●●	34,72	15	15-200	5,5; 6,0; 6,5; 7,0; 7,5; 8,0; 8,5; 9,0; 9,5; 10,0; 11,0
126191 ●●●	37,38	15	15-200	5,5; 6,0; 6,5; 7,0; 7,5; 8,0; 8,5; 9,0; 9,5; 10,0; 11,0

Minimum differential pressure required

This is given by the sum of two values:

- the minimum working Δp of the AUTOFLOW® cartridge;
- the Δp required for the nominal flow rate to pass through the valve body. This value can be determined on the basis of the values of Kv shown above referring to the valve body.

$$\text{Pump head } H = \Delta p_{\text{circuit}} + \Delta p_{\text{request}}$$

Method of coding AUTOFLOW® 121 - 126 - 127 - 128 series

For correct identification of the device, fill in the form indicating: series, size, flow rate and Δp range.

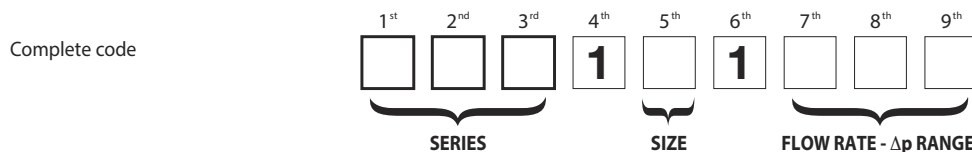

SERIES



121	AUTOFLOW® regulator and ball valve
126	AUTOFLOW® regulator
127	AUTOFLOW® compact regulator
128	AUTOFLOW® compact regulator

SIZE



Size	1/2"	3/4"	1"	1 1/4"	1 1/2"	2"
Digit	4	5	6	7	8	9

FLOW RATE - Δp RANGE



The last three digits indicate the available flow rate

Δp range 20-200 kPa					
m³/h	digit	m³/h	digit	m³/h	digit
0,02	M02	0,04	M04	0,06	M06

Δp range 15-200 kPa											
m³/h	digit	m³/h	digit	m³/h	digit	m³/h	digit	m³/h	digit	m³/h	digit
0,085	M08	0,40	M40	1,20	1M2	2,75	2M7	4,50	4M5	7,50	7M5
0,12	M12	0,50	M50	1,40	1M4	3,00	3M0	4,75	4M7	8,00	8M0
0,15	M15	0,60	M60	1,60	1M6	3,25	3M2	5,00	5M0	8,50	8M5
0,20	M20	0,70	M70	1,80	1M8	3,50	3M5	5,50	5M5	9,00	9M0
0,25	M25	0,80	M80	2,00	2M0	3,75	3M7	6,00	6M0	9,50	9M5
0,30	M30	0,90	M90	2,25	2M2	4,00	4M0	6,50	6M5	10,0	10M
0,35	M35	1,00	1M0	2,50	2M5	4,25	4M2	7,00	7M0	11,0	11M

AUTOMATIC FLOW RATE REGULATOR WITH STAINLESS STEEL CARTRIDGE AND BALL VALVE

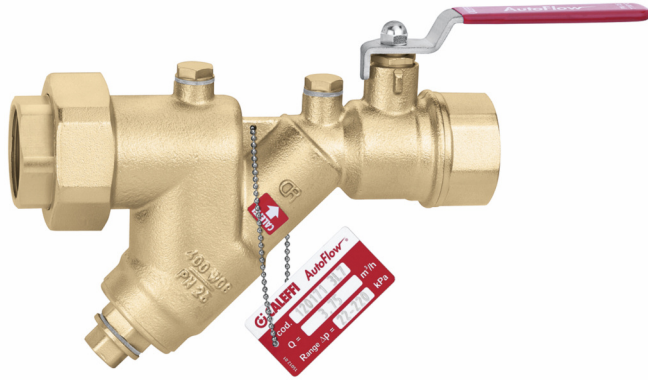

120 AUTOFLOW®

tech. broch. 01041

Combination of automatic flow rate regulator and ball valve.
 CR dezincification resistant alloy body.
 Stainless steel AUTOFLOW® cartridge.
 Max. working pressure: 25 bar.
 Temperature range: 0–110°C.
 Max. percentage of glycol: 50%.
 Δp range: 7–100 kPa; 22–220 kPa; 35–410 kPa.
 Flow rates: 0,12–15,5 m³/h.
 Accuracy: ±5%.

Fitted for connection of pressure ports and drain valve.

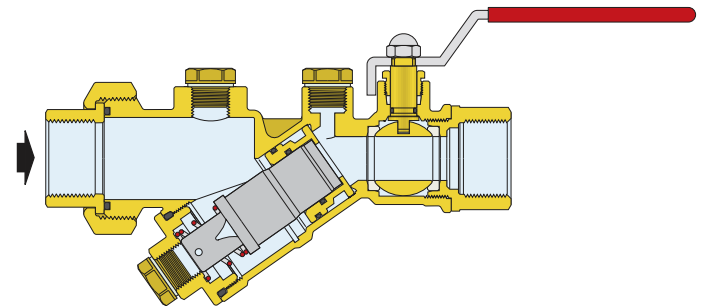

Code				
120141 ●●●	1/2"		1	–
120151 ●●●	3/4"		1	–
120161 ●●●	1"		1	–
120171 ●●●	1 1/4"		1	–
120181 ●●●	1 1/2"		1	–
120191 ●●●	2"		1	–

Code	Kv (m³/h)	Min. working Δp (kPa)	Δp range (kPa)	Flow rates (m³/h)
120141 ●●●	6,90	7	7–100	0,45; 0,5; 0,6; 0,7; 0,8; 0,9; 1,0
120151 ●●●	7,73	7	7–100	0,45; 0,5; 0,6; 0,7; 0,8; 0,9; 1,0
120161 ●●●	17,04	7	7–100	0,7; 0,8; 0,9; 1,0

Code	Kv (m³/h)	Min. working Δp (kPa)	Δp range (kPa)	Flow rates (m³/h)
120141 ●●●	6,90	22	22–220	0,12; 0,15; 0,2; 0,25; 0,3; 0,35; 0,4; 0,5; 0,6; 0,7; 0,8; 0,9; 1,0; 1,2; 1,4; 1,6; 1,8
120151 ●●●	7,73	22	22–220	0,12; 0,15; 0,2; 0,25; 0,3; 0,35; 0,4; 0,5; 0,6; 0,7; 0,8; 0,9; 1,0; 1,2; 1,4; 1,6; 1,8
120161 ●●●	17,04	22	22–220	0,7; 0,8; 0,9; 1,0; 1,2; 1,4; 1,6; 1,8; 2,0; 2,25; 2,5; 2,75; 3,0; 3,25; 3,5; 3,75; 4,0; 4,25
120171 ●●●	17,74	22	22–220	0,7; 0,8; 0,9; 1,0; 1,2; 1,4; 1,6; 1,8; 2,0; 2,25; 2,5; 2,75; 3,0; 3,25; 3,5; 3,75; 4,0; 4,25
120181 ●●●	47,24	22	22–220	2,75; 3,0; 3,25; 3,5; 3,75; 4,0; 4,25; 4,5; 5,0; 5,5; 6,0; 6,5; 7,0; 7,5; 8,0; 8,5; 9,0; 9,5; 10,0; 11,0
120191 ●●●	48,89	22	22–220	2,75; 3,0; 3,25; 3,5; 3,75; 4,0; 4,25; 4,5; 5,0; 5,5; 6,0; 6,5; 7,0; 7,5; 8,0; 8,5; 9,0; 9,5; 10,0; 11,0

Code	Kv (m³/h)	Min. working Δp (kPa)	Δp range (kPa)	Flow rates (m³/h)
120141 ●●●	6,90	35	35–410	0,25; 0,35; 0,45; 0,55; 0,7; 0,9; 1,1; 1,4; 1,6; 1,8; 2,0; 2,25; 2,5; 2,75
120151 ●●●	7,73	35	35–410	0,25; 0,35; 0,45; 0,55; 0,7; 0,9; 1,1; 1,4; 1,6; 1,8; 2,0; 2,25; 2,5; 2,75
120161 ●●●	17,04	35	35–410	1,6; 1,8; 2,0; 2,25; 2,5; 2,75; 3,0; 3,25; 3,5; 3,75; 4,0; 4,25; 4,5; 5,0; 5,5; 6,0
120171 ●●●	17,74	35	35–410	1,6; 1,8; 2,0; 2,25; 2,5; 2,75; 3,0; 3,25; 3,5; 3,75; 4,0; 4,25; 4,5; 5,0; 5,5; 6,0
120181 ●●●	47,24	35	35–410	3,0; 3,25; 3,5; 3,75; 4,0; 4,25; 4,5; 6,5; 7,0; 7,5; 8,0; 8,5; 9,0; 9,5; 10,0; 11,0; 12,0; 13,0; 14,5; 15,5
120191 ●●●	48,89	35	35–410	3,0; 3,25; 3,5; 3,75; 4,0; 4,25; 4,5; 6,5; 7,0; 7,5; 8,0; 8,5; 9,0; 9,5; 10,0; 11,0; 12,0; 13,0; 14,5; 15,5

●●● For code completion see method of coding on page 180

Minimum differential pressure required

This is given by the sum of two values:

1. the minimum working Δp of the AUTOFLOW® cartridge;
2. the Δp required for the nominal flow rate to pass through the valve body. This value can be determined on the basis of the values of Kv shown above referring to the valve body.

$$\text{Pump head } H = \Delta p_{\text{circuit}} + \Delta p_{\text{require}}$$

AUTOMATIC FLOW RATE REGULATOR WITH STAINLESS STEEL CARTRIDGE

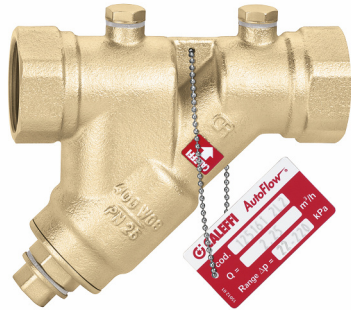

125 AUTOFLOW®

tech. broch. 01041

Automatic flow rate regulator.
 CR dezincification resistant alloy body.
 Stainless steel AUTOFLOW® cartridge.
 Max. working pressure: 25 bar.
 Temperature range: -20–110°C.
 Max. percentage of glycol: 50%.
 Δp range: 7–100 kPa; 22–220 kPa; 35–410 kPa.
 Flow rates: 0,12–17 m³/h.
 Accuracy: ±5%.

Fitted for connection of pressure ports and drain valve.

Code

Code	Size	Green box	Yellow box
125141 ●●●	1/2"	1	–
125151 ●●●	3/4"	1	–
125161 ●●●	1"	1	–
125171 ●●●	1 1/4"	1	–
125181 ●●●	1 1/2"	1	–
125191 ●●●	2"	1	–
125101 ●●●	2 1/2"	1	–

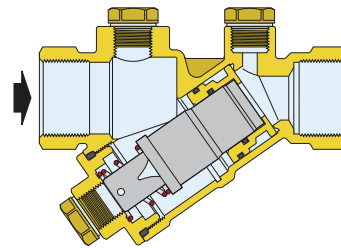

Code	Kv (m³/h)	Min. working Δp (kPa)	Δp range (kPa)	Flow rates (m³/h)
125141 ●●●	6,69	7	7–100	0,45; 0,5; 0,6; 0,7; 0,8; 0,9; 1,0
125151 ●●●	7,58	7	7–100	0,45; 0,5; 0,6; 0,7; 0,8; 0,9; 1,0
125161 ●●●	13,42	7	7–100	0,7; 0,8; 0,9; 1,0

Code	Kv (m³/h)	Min. working Δp (kPa)	Δp range (kPa)	Flow rates (m³/h)
125141 ●●●	6,69	22	22–220	0,12; 0,15; 0,2; 0,25; 0,3; 0,35; 0,4; 0,5; 0,6; 0,7; 0,8; 0,9; 1,0; 1,2; 1,4; 1,6; 1,8
125151 ●●●	7,58	22	22–220	0,12; 0,15; 0,2; 0,25; 0,3; 0,35; 0,4; 0,5; 0,6; 0,7; 0,8; 0,9; 1,0; 1,2; 1,4; 1,6; 1,8
125161 ●●●	13,42	22	22–220	0,7; 0,8; 0,9; 1,0; 1,2; 1,4; 1,6; 1,8; 2,0; 2,25; 2,5; 2,75; 3,0; 3,25; 3,5; 3,75; 4,0; 4,25
125171 ●●●	13,26	22	22–220	0,7; 0,8; 0,9; 1,0; 1,2; 1,4; 1,6; 1,8; 2,0; 2,25; 2,5; 2,75; 3,0; 3,25; 3,5; 3,75; 4,0; 4,25
125181 ●●●	34,72	22	22–220	2,75; 3,0; 3,25; 3,5; 3,75; 4,0; 4,25; 4,5; 5,0; 5,5; 6,0; 6,5; 7,0; 7,5; 8,0; 8,5; 9,0; 9,5; 10,0; 11,0
125191 ●●●	37,38	22	22–220	2,75; 3,0; 3,25; 3,5; 3,75; 4,0; 4,25; 4,5; 5,0; 5,5; 6,0; 6,5; 7,0; 7,5; 8,0; 8,5; 9,0; 9,5; 10,0; 11,0
125101 ●●●	75,82	22	22–220	9,0; 9,5; 10,0; 11,0; 12,0; 13,5; 14,5; 15,5; 16,5; 17,0

Code	Kv (m³/h)	Min. working Δp (kPa)	Δp range (kPa)	Flow rates (m³/h)
125141 ●●●	6,69	35	35–410	0,25; 0,35; 0,45; 0,55; 0,7; 0,9; 1,1; 1,4; 1,6; 1,8; 2,0; 2,25; 2,5; 2,75
125151 ●●●	7,58	35	35–410	0,25; 0,35; 0,45; 0,55; 0,7; 0,9; 1,1; 1,4; 1,6; 1,8; 2,0; 2,25; 2,5; 2,75
125161 ●●●	13,42	35	35–410	2,5; 2,75; 3,0; 3,25; 3,5; 3,75; 4,0; 4,25; 4,5; 5,0; 5,5; 6,0
125171 ●●●	13,26	35	35–410	2,5; 2,75; 3,0; 3,25; 3,5; 3,75; 4,0; 4,25; 4,5; 5,0; 5,5; 6,0
125181 ●●●	34,72	35	35–410	3,0; 3,25; 3,5; 3,75; 4,0; 4,25; 4,5; 6,5; 7,0; 7,5; 8,0; 8,5; 9,0; 9,5; 10,0; 11,0; 12,0; 13,0; 14,5; 15,5
125191 ●●●	37,38	35	35–410	3,0; 3,25; 3,5; 3,75; 4,0; 4,25; 4,5; 6,5; 7,0; 7,5; 8,0; 8,5; 9,0; 9,5; 10,0; 11,0; 12,0; 13,0; 14,5; 15,5
125101 ●●●	75,82	35	35–410	6,5; 7,0; 7,5; 8,0; 8,5; 9,0; 9,5; 11,0

●●● For code completion see method of coding on page 180

Minimum differential pressure required

This is given by the sum of two values:

1. the minimum working Δp of the AUTOFLOW® cartridge;
2. the Δp required for the nominal flow rate to pass through the valve body. This value can be determined on the basis of the values of Kv shown above referring to the valve body.

$$\text{Pump head } H = \Delta p_{\text{circuit}} + \Delta p_{\text{require}}$$

Method of coding AUTOFLOW® 120 - 125 series

For correct identification of the device, fill in the form indicating: series, size, flow rate and Δp range.

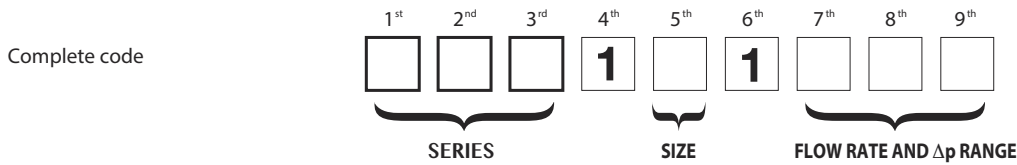

SERIES

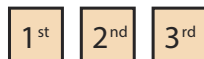

The first three digits indicate the series:

120	AUTOFLOW® regulator and ball valve
125	AUTOFLOW® regulator

SIZE



The fifth digit indicates the size:

Size	1/2"	3/4"	1"	1 1/4"	1 1/2"	2"	2 1/2"
Digit	4	5	6	7	8	9	0

FLOW RATE AND Δp RANGE

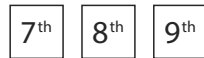

The last three digits indicate the available flow rates.

Δp range 7–100 kPa					
m ³ /h	digit	m ³ /h	digit	m ³ /h	digit
0,45	S45	0,60	S60	0,80	S80
0,50	S50	0,70	S70	0,90	S90
				1,00	1S0

Δp range 22–220 kPa											
m ³ /h	digit	m ³ /h	digit	m ³ /h	digit	m ³ /h	digit	m ³ /h	digit	m ³ /h	digit
0,12	L12	0,60	L60	1,80	1L8	3,75	3L7	7,00	7L0	12,0	12L
0,15	L15	0,70	L70	2,00	2L0	4,00	4L0	7,50	7L5	13,5	13L
0,20	L20	0,80	L80	2,25	2L2	4,25	4L2	8,00	8L0	14,5	14L
0,25	L25	0,90	L90	2,50	2L5	4,50	4L5	8,50	8L5	15,5	15L
0,30	L30	1,00	1L0	2,75	2L7	5,00	5L0	9,00	9L0	16,5	16L
0,35	L35	1,20	1L2	3,00	3L0	5,50	5L5	9,50	9L5	17,0	17L
0,40	L40	1,40	1L4	3,25	3L2	6,00	6L0	10,0	10L		
0,50	L50	1,60	1L6	3,50	3L5	6,50	6L5	11,0	11L		

Δp range 35–410 kPa											
m ³ /h	digit	m ³ /h	digit	m ³ /h	digit	m ³ /h	digit	m ³ /h	digit	m ³ /h	digit
0,25	H25	1,40	1H4	3,00	3H0	5,00	5H0	8,50	8H5	14,5	14H
0,35	H35	1,60	1H6	3,25	3H2	5,50	5H5	9,00	9H0	15,5	15H
0,45	H45	1,80	1H8	3,50	3H5	6,00	6H0	9,50	9H5		
0,55	H55	2,00	2H0	3,75	3H7	6,50	6H5	10,0	10H		
0,70	H70	2,25	2H2	4,00	4H0	7,00	7H0	11,0	11H		
0,90	H90	2,50	2H5	4,25	4H2	7,50	7H5	12,0	12H		
1,10	1H1	2,75	2H7	4,50	4H5	8,00	8H0	13,0	13H		

STAINLESS STEEL CARTRIDGES



Spare AUTOFLOW® cartridge complete with metal tag and metal chain for fixing to the body of the AUTOFLOW® device.
Available in different models depending on the flow rate.
The different colours identify the available models.

NOTE: When ordering, give the full code of the AUTOFLOW® device into which the cartridge is to be fitted (code shown on the metal plate supplied with every AUTOFLOW® device).

**Δp range
7–100 kPa**

Code	Flow rate (m³/h)	Code	Flow rate (m³/h)
03S45 XXX	0,45	04S70 XXF	0,70
03S50 XXX	0,50	04S80 XXF	0,80
03S60 XXX	0,60	04S90 XXF	0,90
03S70 XXX	0,70	041S0 XXF	1,00
03S80 XXX	0,80		
03S90 XXX	0,90		
031S0 XXX	1,00		

For 1" new bodies with new cartridge.

Code Flow rate (m³/h)

**Δp range
22–220 kPa**

Code	Flow rate (m³/h)	Code	Flow rate (m³/h)
03L12 XXX	0,12	04L70 XXF	0,70
03L15 XXX	0,15	04L80 XXF	0,80
03L20 XXX	0,20	04L90 XXF	0,90
03L25 XXX	0,25	041L0 XXF	1,00
03L30 XXX	0,30	041L2 XXF	1,20
03L35 XXX	0,35	041L4 XXF	1,40
03L40 XXX	0,40	041L6 XXF	1,60
03L50 XXX	0,50	041L8 XXF	1,80
03L60 XXX	0,60	042L0 XXF	2,00
03L70 XXX	0,70	042L2 XXF	2,25
03L80 XXX	0,80	042L5 XXF	2,50
03L90 XXX	0,90	042L7 XXF	2,75
031L0 XXX	1,00	043L0 XXF	3,00
031L2 XXX	1,20	043L2 XXF	3,25
031L4 XXX	1,40	043L5 XXF	3,50
031L6 XXX	1,60	043L7 XXF	3,75
031L8 XXX	1,80	044L0 XXF	4,00
		044L2 XXF	4,25

For 1" - 1 1/4" new bodies with new cartridge.

Code Flow rate (m³/h)

For 2 1/2" new bodies with new cartridge.

069L0 XXF	9,00
069L5 XXF	9,50
0610L XXF	10,00
0611L XXF	11,00
0612L XXF	12,00
0613L XXF	13,00
0614L XXF	14,00
0615L XXF	15,00
0616L XXF	16,00
0617L XXF	17,00

**Δp range
35–410 kPa**

Code	Flow rate (m³/h)	Code	Flow rate (m³/h)
03H25 XXX	0,25	042H5 XXF	2,50
03H35 XXX	0,35	042H7 XXF	2,75
03H45 XXX	0,45	043H0 XXF	3,00
03H55 XXX	0,55	043H2 XXF	3,25
03H70 XXX	0,70	043H5 XXF	3,50
03H90 XXX	0,90	043H7 XXF	3,75
031H1 XXX	1,10	044H0 XXF	4,00
031H4 XXX	1,40	044H2 XXF	4,25
031H6 XXX	1,60	044H5 XXF	4,50
031H8 XXX	1,80	056H5 XXX	6,50
032H0 XXX	2,00	057H0 XXX	7,00
032H2 XXX	2,25	057H5 XXX	7,50
032H5 XXX	2,50	058H0 XXX	8,00
032H7 XXX	2,75	058H5 XXX	8,50
043H0 XXX	3,00	059H0 XXX	9,00
043H2 XXX	3,25	059H5 XXX	9,50
043H5 XXX	3,50	0510H XXX	10,00
043H7 XXX	3,75	0511H XXX	11,00
044H0 XXX	4,00	0512H XXX	12,00
044H2 XXX	4,25	0513H XXX	13,00
044H5 XXX	4,50	0514H XXX	14,50
056H5 XXX	6,50	0515H XXX	15,50
057H0 XXX	7,00		
057H5 XXX	7,50		
058H0 XXX	8,00		
058H5 XXX	8,50		
059H0 XXX	9,00		
059H5 XXX	9,50		
0510H XXX	10,00		
0511H XXX	11,00		
0512H XXX	12,00		
0513H XXX	13,00		
0514H XXX	14,50		
0515H XXX	15,50		

For 1" - 1 1/4" new bodies with new cartridge.

Code Flow rate (m³/h)

STRAINERS



**120
STRAINER**

tech. broch. 01041

Combination of Y-strainer and ball valve.
 CR dezincification resistant alloy body.
 Stainless steel strainer cartridge.
 Max. working pressure: 25 bar.
 Temperature range: 0–110°C.
 Max. percentage of glycol: 50%.
 Strainer mesh size Ø: 1/2"–1 1/4": 0,87 mm; 1 1/2" and 2": 0,73 mm.

Fitted for connection of pressure ports and drain valve.



Code		Kv (m ³ /h)		
120141 000	1/2"	6,87	1	–
120151 000	3/4"	7,25	1	–
120161 000	1"	16,65	1	–
120171 000	1 1/4"	17,23	1	–
120181 000	1 1/2"	39,13	1	–
120191 000	2"	39,69	1	–

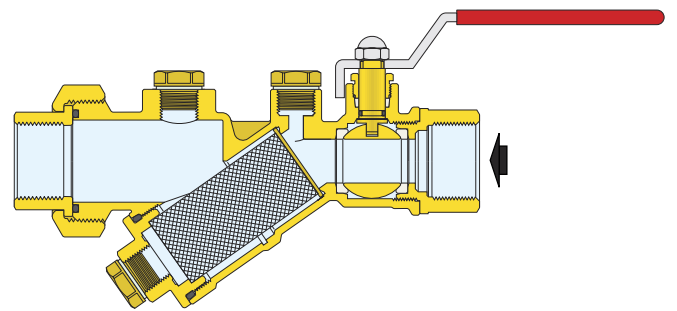

Pressure drop

- The indicated Kv value refers to the valve complete with strainer.

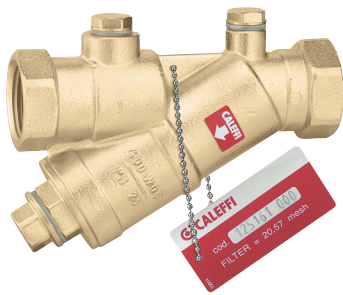

**125
STRAINER**

tech. broch. 01041

Y-strainer.
 CR dezincification resistant alloy body.
 Stainless steel strainer cartridge.
 Max. working pressure: 25 bar.
 Temperature range: -20–110°C.
 Max. percentage of glycol: 50%.
 Strainer mesh size Ø: 1/2"–1 1/4": 0,87 mm; 1 1/2"–2 1/2": 0,73 mm.

Fitted for connection of pressure ports and drain valve.



Code		Kv (m ³ /h)		
125141 000	1/2"	6,88	1	–
125151 000	3/4"	7,05	1	–
125161 000	1"	14,10	1	–
125171 000	1 1/4"	14,94	1	–
125181 000	1 1/2"	32,27	1	–
125191 000	2"	36,21	1	–
125101 000	2 1/2"	68,25	1	–

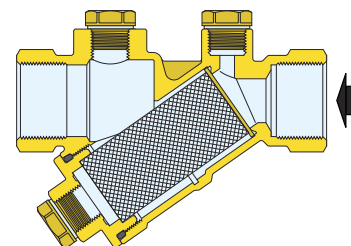

Pressure drop

- The indicated Kv value refers to the valve complete with strainer.

AUTOMATIC FLOW REGULATOR WITH STAINLESS STEEL CARTRIDGE



103 AUTOFLOW®

tech. broch. 01041

Automatic flow rate regulator, flanged version.
 Cast iron body.
 Stainless steel AUTOFLOW® cartridge.
 Max. working pressure: 16 bar.
 Temperature range: -20–110°C.
 Max. percentage of glycol: 50%.
 Δp range: 22–210 kPa; 40–390 kPa; 55–210 kPa.
 Flow rates: 9–4400 m³/h.
 Accuracy: ±5%.

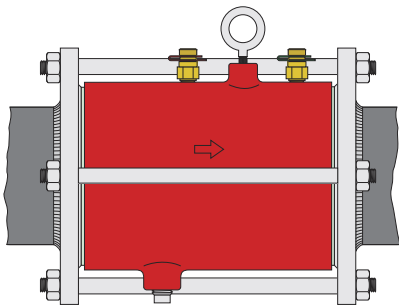
Supplied with flat counterflanges EN 1092-1 PN 16, rods, gasket and quick-fit pressure test ports.



Code	DN	Min. working (kPa)	Flow rates (m³/h)	Δp range (kPa)		
103111 ●●●	65	22	9– 17	22–210	1	–
103113 ●●●	65	40	18– 22	40–390	1	–
103114 ●●●	65	55	25– 36	55–210	1	–
103121 ●●●	80	22	9– 17	22–210	1	–
103123 ●●●	80	40	18– 22	40–390	1	–
103124 ●●●	80	55	25– 36	55–210	1	–
103131 ●●●	100	22	9– 17	22–210	1	–
103133 ●●●	100	40	18– 22	40–390	1	–
103134 ●●●	100	55	25– 36	55–210	1	–
103431 ●●●	100*	22	18– 34	22–210	1	–
103433 ●●●	100*	40	23– 45	40–390	1	–
103434 ●●●	100*	55	46– 73	55–210	1	–
103141 ●●●	125	22	18– 34	22–210	1	–
103143 ●●●	125	40	23– 45	40–390	1	–
103144 ●●●	125	55	46– 73	55–210	1	–
103151 ●●●	150	22	40– 68	22–210	1	–
103153 ●●●	150	40	40– 91	40–390	1	–
103154 ●●●	150	55	92–145	55–210	1	–
103161 ●●●	200	22	80–119	22–210	1	–
103163 ●●●	200	40	80–159	40–390	1	–
103164 ●●●	200	55	160–255	55–210	1	–
103171 ●●●	250	22	110–187	22–210	1	–
103173 ●●●	250	40	110–250	40–390	1	–
103174 ●●●	250	55	251–400	55–210	1	–
103181 ●●●	300	22	150–255	22–210	1	–
103183 ●●●	300	40	150–341	40–390	1	–
103184 ●●●	300	55	342–545	55–210	1	–

* Supplied with 4" ANSI flanges.

Available on request with sizes from DN 350 to DN 1000, with flow rates up to 4400 m³/h.

Minimum differential pressure required

This is equal to the min. working Δp of the AUTOFLOW® cartridge (22, 40 or 55 kPa).
 Pump head H = Δp_{circuit} + Δp_{require}

Method of coding AUTOFLOW® 103 series

For correct identification of the device, fill in the form indicating: size, Δp range and flow rate.

Complete code

1	0	3	1						
SERIES			SIZE	Δp RANGE	FLOW RATE				

SIZE	5 th	The fifth digit indicates the size	<table border="1" style="width: 100%; text-align: center; border-collapse: collapse;"> <tr><td>DN</td><td>65</td><td>80</td><td>100</td><td>125</td><td>150</td><td>200</td><td>250</td><td>300</td></tr> <tr><td>Digit</td><td>1</td><td>2</td><td>3</td><td>4</td><td>5</td><td>6</td><td>7</td><td>8</td></tr> </table>	DN	65	80	100	125	150	200	250	300	Digit	1	2	3	4	5	6	7	8
DN	65	80	100	125	150	200	250	300													
Digit	1	2	3	4	5	6	7	8													
Δp RANGE	6 th	The sixth digit indicates differential pressure range (Δp range)	<table border="1" style="width: 100%; text-align: center; border-collapse: collapse;"> <tr><td>kPa</td><td>22–210</td><td>40–390</td><td>55–210</td></tr> <tr><td>Digit</td><td>1</td><td>3</td><td>4</td></tr> </table>	kPa	22–210	40–390	55–210	Digit	1	3	4										
kPa	22–210	40–390	55–210																		
Digit	1	3	4																		
FLOW RATE	7 th 8 th 9 th	The last three digits indicate the flow rate values.																			

BALANCING VALVE WITH FLOW METER

132

tech. broch. 01149





Balancing valve with flow meter.
Direct reading of flow rate.
Brass valve body and flow meter.
Ball valve for flow rate adjustment.
Graduated scale flow meter with magnetic movement flow rate indicator.

With insulation.

Max. working pressure: 10 bar.
Temperature range: -10–110°C.
Max. percentage of glycol: 50%.
PATENT PENDING.





Code	Flow rate range (l/min)		
132402	1/2" 2– 7	1	5
132512	3/4" 5– 13	1	5
132522	3/4" 7– 28	1	5
132602	1" 10– 40	1	5
132702	1 1/4" 20– 70	1	5
132802	1 1/2" 30–120	1	5
132902	2" 50–200	1	5

132

Balancing valve with flow meter.
Direct reading of flow rate.
Cast iron body.
Brass flow meter.
Characterized ball valve for flow rate adjustment.
Graduated scale flow meter with magnetic movement flow rate indicator.
Max. working pressure: 10 bar.
Temperature range: -10–110°C.
Max. percentage of glycol: 50%.
Flanged connections PN 16.
To be coupled with flat counterflanges EN 1092-2.



Code	Flow rate range (m³/h)		
132060	DN 65 6–24	1	–
132080	DN 80 8–32	1	–
132100	DN 100 12–48	1	–

Flow rate adjustment

The flow rate is adjusted by carrying out the following operations:

1. With the aid of the indicator (1), mark the reference flow rate at which the valve has to be set.
2. Use the ring (2) to open the obturator that shuts off the flow of medium in the flow meter (3) under normal operating conditions.

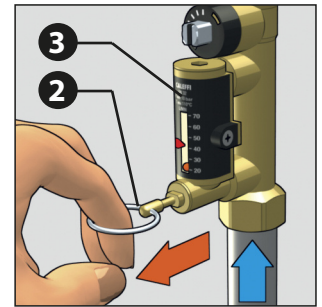
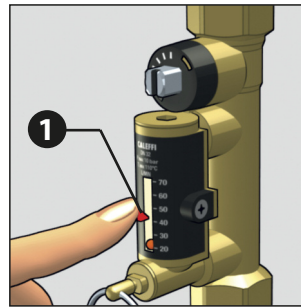

3. Keeping the obturator open, apply a wrench on the control stem of the valve (4) to adjust the flow rate. It is indicated by a metal ball (5) that runs inside a transparent guide (6) marked by a graduated scale in l/min.

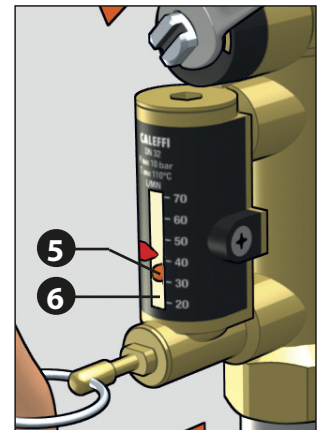
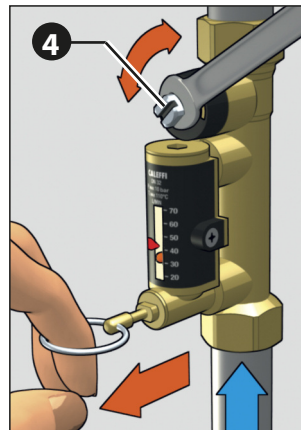

4. After completing the balancing, release the ring (2) of the flow meter obturator that, thanks to an internal spring, will automatically go back into the closed position.
5. After completing the balancing, the indicator (1) can be used to keep in memory the selected setting in case of future inspections.

Complete opening and closing of the valve

Complete opening of the valve

Complete closing of the valve

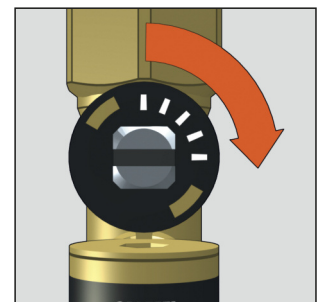
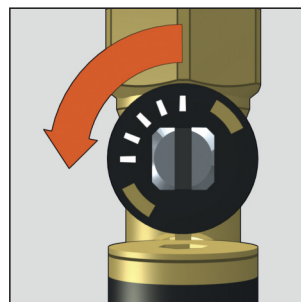

BALANCING VALVES

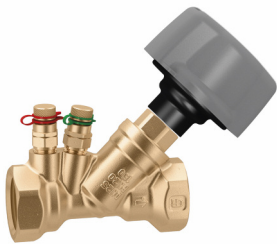

130

tech. broch. 01251

Balancing valve for hydraulic systems. Flow rate measurement with Venturi device. CR dezincification resistant alloy body, stainless steel obturator. Complete with pressure ports. Max. working pressure: 16 bar. Temperature range: -20-120°C. Max. percentage of glycol: 50%.



Code			
130400	1/2"	1	5
130500	3/4"	1	5
130600	1"	1	5
130700	1 1/4"	1	5
130800	1 1/2"	1	5
130900	2"	1	5



130

tech. broch. 01251

Balancing valve for hydraulic systems. Grey cast iron body, PPS polymer obturator. Complete with pressure ports. Max. working pressure: 16 bar. Temperature range: DN 65-DN 200: -10-140°C DN 250-DN 300: -10-120°C. Max. percentage of glycol: 50%. Flanged connections PN 16. To be coupled with flat counterflanges EN 1092-2.

Code			
130062	DN 65	1	-
130082	DN 80	1	-
130102	DN 100	1	-
130122	DN 125	1	-
130152	DN 150	1	-
130202	DN 200	1	-
130250	DN 250	1	-
130300	DN 300	1	-

Pre-formed insulation for balancing valves with threaded connections 130 series. For heating and air conditioning system.



Code			
CBN130400	1/2"	1	-
CBN130500	3/4"	1	-
CBN130600	1"	1	-
CBN130700	1 1/4"	1	-
CBN130800	1 1/2"	1	-
CBN130900	2"	1	-

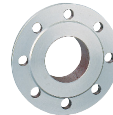

617

Slip-on flat counterflanges for welding, EN 1092-1, PN 16. Complete with bolts and gaskets.

Code			
617060	DN 65 4 holes	1	-
617080	DN 80	1	-
617100	DN 100	1	-
617120	DN 125	1	-
617150	DN 150	1	-
617200	DN 200	1	-
617250	DN 250	1	-
617300	DN 300	1	-

NEW



142

Balancing valve. CR dezincification resistant alloy body. Max. working pressure: 16 bar. Temperature range: -10-120°C. Max. percentage of glycol: 50%.

Code			
142340	1/2"	10	-
142450	3/4"	10	-

DIFFERENTIAL PRESSURE CONTROL VALVE (DPCV)

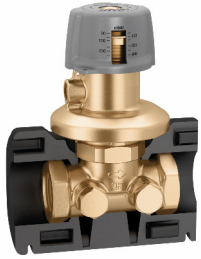



140

tech. broch. 01250

Differential pressure control valve (DPCV).
 CR dezincification resistant alloy body.
 Complete with capillary pipe for connection to the valve on the flow pipe.
With insulation.
 Max. working pressure: 16 bar.
 Temperature range: -10–120°C.
 Max. percentage of glycol: 50%.
 Length of capillary pipe Ø 3 mm: 1,5 m.



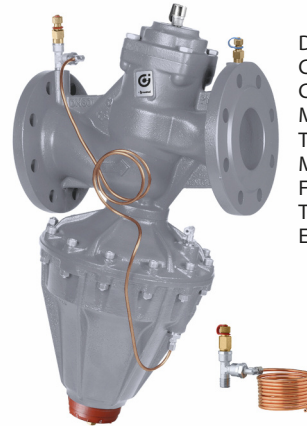

Code	Differential pressure adjustable set (mbar)				
140340	1/2"	50–300		1	5
140440	1/2"	250–600		1	5
140350	3/4"	50–300		1	5
140450	3/4"	250–600		1	5
140360	1"	50–300		1	5
140460	1"	250–600		1	5
140342	1/2"	50–300	without insulation	1	5
140442	1/2"	250–600	without insulation	1	5
140352	3/4"	50–300	without insulation	1	5
140452	3/4"	250–600	without insulation	1	5
140362	1"	50–300	without insulation	1	5
140462	1"	250–600	without insulation	1	5



140

Differential pressure control valve (DPCV).
 Cast iron body.
 Complete with pressure ports.
 Max. working pressure: 16 bar.
 Temperature range: -10–120°C.
 Max. percentage of glycol: 50%.
 Flanged connections PN 16.
 To be coupled with flat counterflanges EN 1092-2.

Code	Differential pressure adjustable set (mbar)				
140506	DN 65	200–800		1	–
140606	DN 65	800–1600		1	–
140508	DN 80	200–800		1	–
140608	DN 80	800–1600		1	–
140510	DN 100	200–800		1	–
140610	DN 100	800–1600		1	–
140512	DN 125	200–800		1	–
140515	DN 150	200–800		1	–





140

tech. broch. 01250

Differential pressure control valve (DPCV).
 CR dezincification resistant alloy body.
 Complete with capillary pipe for connection to the valve on the flow pipe.
With insulation.
 Max. working pressure: 10 bar.
 Temperature range: -10–120°C.
 Max. percentage of glycol: 50%.
 Length of capillary pipe Ø 3 mm: 1,5 m.





Code	Differential pressure adjustable set (mbar)				
140370	1 1/4"	50–300		1	–
140470	1 1/4"	250–600		1	–
140380	1 1/2"	50–300		1	–
140480	1 1/2"	250–600		1	–
140372	1 1/4"	50–300	without insulation	1	–
140472	1 1/4"	250–600	without insulation	1	–
140382	1 1/2"	50–300	without insulation	1	–
140482	1 1/2"	250–600	without insulation	1	–
140392	2"	50–300	without insulation	1	–
140492	2"	250–600	without insulation	1	–



142

tech. broch. 01250

Shut-off and pre-regulation valve.
 CR dezincification resistant alloy body.
 Complete with pressure test ports for connection of capillary pipe.
With insulation.
 Max. working pressure: 16 bar.
 Temperature range: -10–120°C.
 Max. percentage of glycol: 50%.



Code	Differential pressure adjustable set (mbar)				
142140	1/2"			1	5
142150	3/4"			1	5
142160	1"			1	10
142240	1/2"	without insulation		1	10
142250	3/4"	without insulation		1	10
142260	1"	without insulation		1	10



142

tech. broch. 01250

Shut-off and pre-regulation valve.
 CR dezincification resistant alloy body.
 Complete with pressure test ports for connection of capillary pipe.
With insulation.
 Max. working pressure: 16 bar.
 Temperature range: -10–120°C.
 Max. percentage of glycol: 50%.

Code	Differential pressure adjustable set (mbar)				
142170	1 1/4"			1	–
142180	1 1/2"			1	–
142270	1 1/4"	without insulation		1	5
142280	1 1/2"	without insulation		1	5
142290	2"	without insulation		1	–



519

tech. broch. 01007

Differential by-pass valve, adjustable with graduated scale. Max. working pressure: 10 bar. Temperature range: 0–110°C. Max. percentage of glycol: 30%.



Code	Setting range m.w.g.		
519500	3/4"	1–6	1 50
519504	3/4"	10–40	1 50
519700	1 1/4"	1–6	1 10

130

tech. broch. 01251

Electronic flow rate and differential pressure measuring station. Supplied complete with shut-off and connection fittings. Can be used for measuring the flow rate of balancing valves 130, 142 series and of the flow metering device 683 series. Suitable for Δp measurement of automatic flow rate regulators. Electric supply from battery. Bluetooth® transmission between Δp measuring station and remote control unit. Versions complete with remote control unit with Android® application for Smartphone and Tablet. Measurement range: 0–1000 kPa. Static Pmax: 1000 kPa.



Smart Balancing Caleffi Available app for smartphone. Download for your Android® mobile phone.

Code			
130006	complete with remote control unit, with Android® application	1	–
130005	without remote control unit, with Android® application	1	–

Transmission via Bluetooth® to the terminal with Android® application

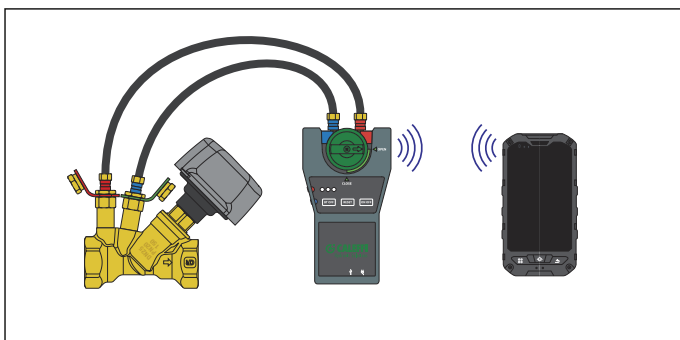

100

tech. broch. 01041

Pair of fast-plug pressure/temperature test ports. Their special construction allows rapid and accurate measurements while ensuring leaktightness.

Can be used for:

- checking the working range of AUTOFLOW®;
- checking the clog degree of strainers;
- checking the heat output of the terminals.

Cap cover facing available in:

- - **Red** for upstream pressure test port.
- - **Green** for downstream pressure test port.



Brass body. EPDM seals. Max. working pressure: 30 bar. Temperature range: -5–130°C.

Code			
100000	1/4"	1	100

100

tech. broch. 01041



Pair of fittings with fast-plug syringe for connection of pressure ports to measuring instruments. 1/4" female threaded connection. Max. working pressure: 10 bar. Max. working temperature: 110°C.

Code			
100010	1/4"	1	–

538

tech. broch. 01041



Drain cock with hose connection and cap. Max. working pressure: 10 bar. Max. working temperature: 110°C.

Code			
538201	1/4" M	1	–
538400	1/2" M	1	100

Transmission via Bluetooth® to Smartphone/Tablet with Android® application

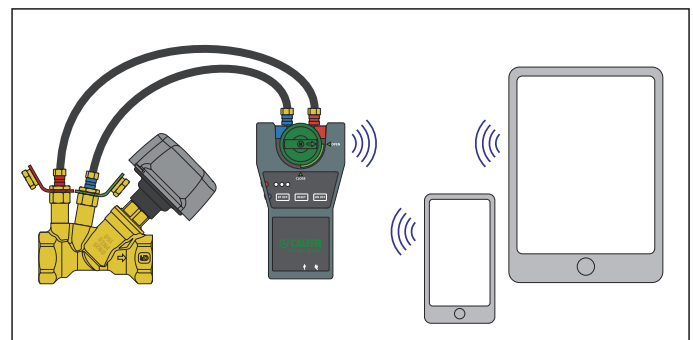

FITTINGS

This diagram is just an indication

MECHANICAL FITTINGS WITH O-RING SEAL

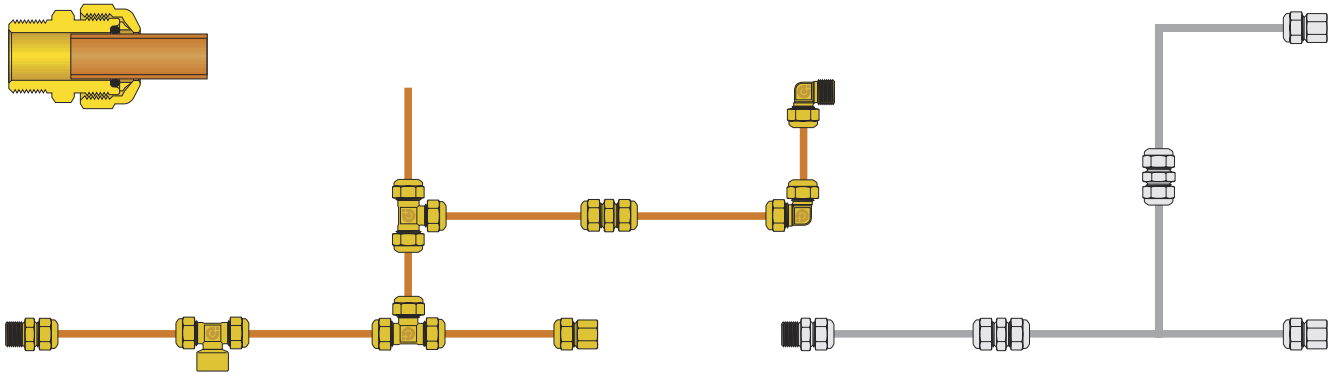

DECA-FITTINGS FOR POLYETHYLENE PIPES

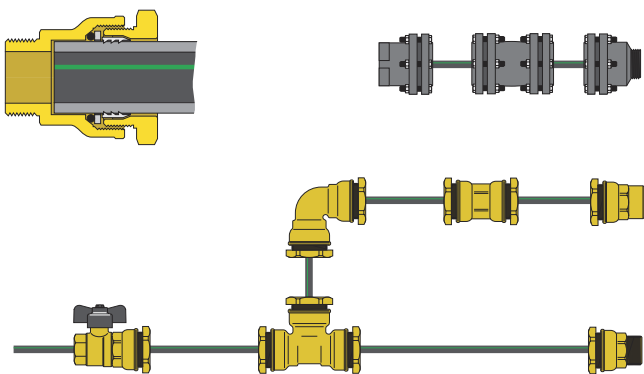

DECA-FITTINGS FOR STEEL PIPES

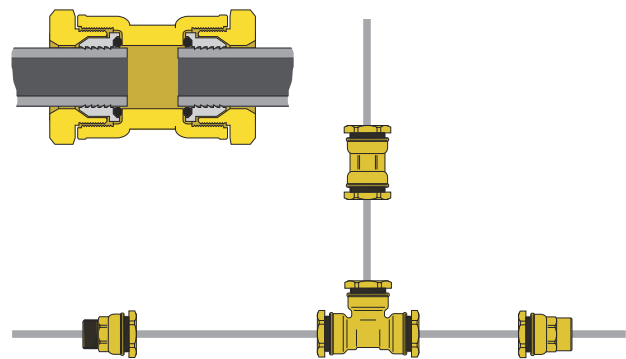

- Three-piece union fittings
- Fittings for polyethylene pipes (PE-X)
- Mechanical fittings with O-Ring seal
- DECA-fittings for polyethylene pipes
- Dezincification resistant alloy fittings for polyethylene pipes
- DECA-fittings for steel pipes

THREE-PIECE UNION FITTINGS

for gas and hydrocarbons - EN 549 standard

for hydraulic and domestic water systems - EN 681.1 standard

Fittings highlighted in yellow are supplied with two O-Rings: yellow to be used for gas and fluid hydrocarbons - black to be used for hydraulic systems.

To be used for gas systems with power output up to 35 kW, according to UNI 7129-2008 standard only.

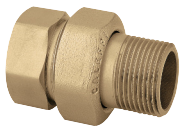

588

Three-piece straight union fitting, PN 16.
For gas and fluid hydrocarbons:
 yellow O-Ring according to EN 549 standard.
 Temperature range: -20–100°C.
For hydraulic and domestic water systems:
 black O-Ring according to EN 681.1 standard.
 Max. working pressure: 16 bar.
 Temperature range: -25–120°C.



Code				
588030	3/8" F	x M with union	1	50
588040	1/2" F	x M with union	1	50
588050	3/4" F	x M with union	1	25
588060	1" F	x M with union	1	20
588070	1 1/4" F	x M with union	1	10
588080	1 1/2" F	x M with union	1	-
588090	2" F	x M with union	1	-

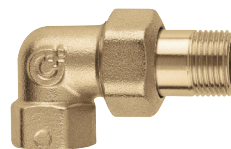

5881

Three-piece elbow union fitting, PN 16.
For gas and fluid hydrocarbons:
 yellow O-Ring according to EN 549 standard.
 Temperature range: -20–100°C.
For hydraulic and domestic water systems:
 black O-Ring according to EN 681.1 standard.
 Max. working pressure: 16 bar.
 Temperature range: -25–120°C.



Code				
588130	3/8" F	x M with union	1	50
588140	1/2" F	x M with union	1	25
588150	3/4" F	x M with union	1	25
588160	1" F	x M with union	1	15
588170	1 1/4" F	x M with union	1	10

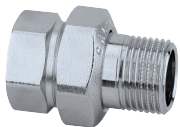

588

Three-piece straight union fitting, PN 16.
 Chrome plated.
For hydraulic and domestic water systems:
 black O-Ring according to EN 681.1 standard.
 Max. working pressure: 16 bar.
 Temperature range: -25–120°C.



Code				
588031	3/8" F	x M with union	1	50
588041	1/2" F	x M with union	1	50
588051	3/4" F	x M with union	1	25
588061	1" F	x M with union	1	20
588071	1 1/4" F	x M with union	1	10
588081	1 1/2" F	x M with union	1	-
588091	2" F	x M with union	1	-

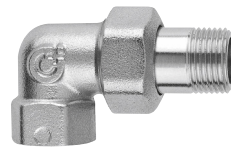

5881

Three-piece elbow union fitting, PN 16.
 Chrome plated.
For hydraulic and domestic water systems:
 black O-Ring according to EN 681.1 standard.
 Max. working pressure: 16 bar.
 Temperature range: -25–120°C.



Code				
588131	3/8" F	x M with union	1	50
588141	1/2" F	x M with union	1	25
588151	3/4" F	x M with union	1	25
588161	1" F	x M with union	1	15
588171	1 1/4" F	x M with union	1	10

UNIONS

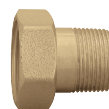

Flat seat union with gasket.

Code		
R59787	3/4" F	x 1/2" M
R59788	1" F	x 3/4" M
R59789	1 1/4" F	x 1" M
R59485	1 1/2" F	x 1 1/4" M
R59581	2" F	x 1 1/2" M
R59487	2 1/2" F	x 2" M

O-Ring seal

The hydraulic tightness between the two fitting components is a tapered type with O-Ring. This allows to screw the fitting up smoothly with a full safety warranty.

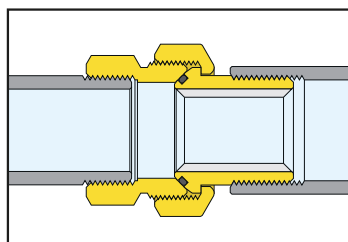

FITTINGS FOR POLYETHYLENE PIPES (PE-X)



933
Elbow fitting
with plastic wall mounting case.

Code			
933000	1/2" F x 23 p.1,5	5	-



930
Male elbow fitting with wall connection.
Fitted for coupling with fittings 347, 438
and 680 series for water use.

Code			
930418	1/2" F x 23 p.1,5 M	5	-



933
Elbow fitting
with plastic wall mounting case
with 10 mm collar.

Code			
933001	1/2" F x 23 p.1,5	5	-
933501	3/4" F x 3/4"	1	10



936
Extension for connection between
elbow fitting 933 series and radiator valve.
Annealed copper, chrome plated.
With shaped rubber seal.
Length: 200 mm
(useful 188 mm).

Code			
936400	1/2" x Ø 16	1	50



R96006
Plastic case plug
for elbow fitting 933 series.

Code			
R96006		5	100

FITTINGS FOR POLYETHYLENE PIPES (PE-X)
Fitted for coupling with 680 and 679 series

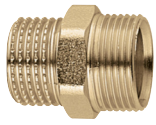

940
Male fitting.

Code			
940300	3/8" M x 23 p.1,5	50	-
940400	1/2" M x 23 p.1,5	50	-
940450	1/2" M x 3/4"	50	-
940500	3/4" M x 23 p.1,5	50	-
940550	3/4" M x 3/4" (use 942550)	50	-
940560	3/4" M x 1" (use 942560)	50	-
940650	1" M x 3/4" (use 942560)	50	-



944
Male elbow fitting.

Code			
944400	1/2" M x 23 p.1,5	50	-
944550	3/4" M x 3/4" (use 943550)	50	-



941
Female fitting.

Code			
941300	3/8" F x 23 p.1,5	50	-
941400	1/2" F x 23 p.1,5	50	-
941450	1/2" F x 3/4"	50	-
941500	3/4" F x 23 p.1,5	50	-
941550	3/4" F x 3/4"	50	-
941560	3/4" F x 1"	50	-



945
Female elbow fitting.

Code			
945400	1/2" F x 23 p.1,5	50	-
945550	3/4" F x 3/4"	50	-



946
Tee piece.

Code			
946000	23 p.1,5 x 23 p.1,5 x 23 p.1,5	50	-
946500	3/4" x 3/4" x 3/4"	25	-

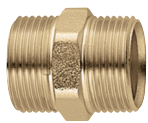

942
Sleeve.

Code			
942000	23 p.1,5 x 23 p.1,5	50	-
942550	3/4" x 3/4"	50	-
942560	3/4" x 1"	50	-



947
Side male tee piece.

Code			
947400	1/2" M x 23 p.1,5 x 23 p.1,5	50	-
947500	3/4" M x 3/4" x 3/4" (use 946500)	50	-



943
Elbow fitting.

Code			
943000	23 p.1,5 x 23 p.1,5	50	-
943550	3/4" x 3/4"	50	-



948
Central male tee piece.

Code			
948400	23 p.1,5 x 1/2" M x 23 p.1,5	50	-
948500	3/4" x 3/4" M x 3/4" (use 946500)	50	-

MECHANICAL FITTINGS WITH O-RING SEAL

according to EN 1254-2 and EN 1254-4 standards

for gas and fluid hydrocarbons - EN 549 standard

for hydraulic and domestic water systems - EN 681.1 standard

Fittings highlighted in yellow are supplied with two O-Rings: yellow to be used for gas and fluid hydrocarbons - black to be used for hydraulic systems



900

Female fitting. For annealed copper, hard copper, brass, mild steel and stainless steel. Double O-Ring. According to EN 1254-4 standard.
For gas and fluid hydrocarbons: yellow O-Ring according to EN 549 standard. Temperature range: -20–100°C.
For hydraulic and domestic water systems: black O-Ring according to EN 681.1 standard. Max. working pressure: 16 bar. Temperature range: -25–120°C.

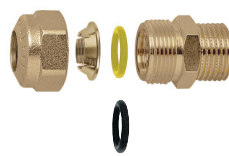

904

Male fitting. For annealed copper, hard copper, brass, mild steel and stainless steel. Double O-Ring. According to EN 1254-4 standard.
For gas and fluid hydrocarbons: yellow O-Ring according to EN 549 standard. Temperature range: -20–100°C.
For hydraulic and domestic water systems: black O-Ring according to EN 681.1 standard. Max. working pressure: 16 bar. Temperature range: -25–120°C.

Code			
900308	3/8" F - Ø 8	50	-
900310	3/8" F - Ø 10	50	-
900312	3/8" F - Ø 12	50	-
900314	3/8" F - Ø 14	50	-
900410	1/2" F - Ø 10	50	-
900412	1/2" F - Ø 12	50	-
900414	1/2" F - Ø 14	50	-
900415	1/2" F - Ø 15	50	-
900416	1/2" F - Ø 16	50	-
900418	1/2" F - Ø 18	25	-
900516	3/4" F - Ø 16	50	-
900518	3/4" F - Ø 18	25	-
900522	3/4" F - Ø 22	25	-
900622	1" F - Ø 22	25	-
900628*	1" F - Ø 28	25	-

Code			
904308	3/8" M - Ø 8	50	-
904310	3/8" M - Ø 10	50	-
904312	3/8" M - Ø 12	50	-
904314	3/8" M - Ø 14	50	-
904410	1/2" M - Ø 10	50	-
904412	1/2" M - Ø 12	50	-
904414	1/2" M - Ø 14	50	-
904415	1/2" M - Ø 15	50	-
904416	1/2" M - Ø 16	50	-
904418	1/2" M - Ø 18	25	-
904514	3/4" M - Ø 14	50	-
904516	3/4" M - Ø 16	50	-
904518	3/4" M - Ø 18	25	-
904522	3/4" M - Ø 22	25	-
904618	1" M - Ø 18	25	-
904622	1" M - Ø 22	25	-
904628 *	1" M - Ø 28	10	-

* To be used only with water and non-dangerous glycol solutions

* To be used only with water and non-dangerous glycol solutions



903

Coupling sleeve. For annealed copper, hard copper, brass, mild steel and stainless steel. According to EN 1254-2 standard.
For hydraulic and domestic water systems: black O-Ring according to EN 681.1 standard. Max. working pressure: 16 bar. Temperature range: -25–120°C.



9050

Elbow fitting. For annealed copper, hard copper, brass, mild steel and stainless steel. According to EN 1254-2 standard.
For hydraulic and domestic water systems: black O-Ring according to EN 681.1 standard. Max. working pressure: 16 bar. Temperature range: -25–120°C.

Code			
903008	Ø 8	50	-
903010	Ø 10	50	-
903012	Ø 12	50	-
903014	Ø 14	50	-
903015	Ø 15	50	-
903016	Ø 16	50	-
903018	Ø 18	25	-
903022	Ø 22	25	-

Code			
905010	Ø 10	25	-
905012	Ø 12	25	-
905014	Ø 14	25	-
905015	Ø 15	25	-
905016	Ø 16	25	-
905018	Ø 18	25	-
905022	Ø 22	25	-

MECHANICAL FITTINGS WITH O-RING SEAL

9057



Male elbow fitting. For annealed copper, hard copper, brass, mild steel and stainless steel. Double O-Ring. According to EN 1254-4 standard. **For gas and fluid hydrocarbons:** yellow O-Ring according to EN 549 standard. Temperature range: -20–100°C. **For hydraulic and domestic water systems:** black O-Ring according to EN 681.1 standard. Max. working pressure: 16 bar. Temperature range: -25–120°C.

Code



905730	3/8" M - Ø 10	25	-
905732	3/8" M - Ø 12	25	-
905740	1/2" M - Ø 10	25	-
905742	1/2" M - Ø 12	25	-
905744	1/2" M - Ø 14	25	-
905745	1/2" M - Ø 15	25	-
905746	1/2" M - Ø 16	25	-
905748	1/2" M - Ø 18	25	-
905756	3/4" M - Ø 16	25	-
905758	3/4" M - Ø 18	25	-
905752	3/4" M - Ø 22	25	-

9060



Tee fitting. For annealed copper, hard copper, brass, mild steel and stainless steel. According to EN 1254-2 standard. **For hydraulic and domestic water systems:** black O-Ring according to EN 681.1 standard. Max. working pressure: 16 bar. Temperature range: -25–120°C.

Code



906010	Ø 10	25	-
906012	Ø 12	25	-
906014	Ø 14	25	-
906015	Ø 15	25	-
906016	Ø 16	25	-
906018	Ø 18	25	-
906022	Ø 22	20	-

9058



Female elbow fitting. For annealed copper, hard copper, brass, mild steel and stainless steel. Double O-Ring. According to EN 1254-4 standard. **For gas and fluid hydrocarbons:** yellow O-Ring according to EN 549 standard. Temperature range: -20–100°C. **For hydraulic and domestic water systems:** black O-Ring according to EN 681.1 standard. Max. working pressure: 16 bar. Temperature range: -25–120°C.

Code



905830	3/8" F - Ø 10	25	-
905832	3/8" F - Ø 12	25	-
905840	1/2" F - Ø 10	25	-
905842	1/2" F - Ø 12	25	-
905844	1/2" F - Ø 14	25	-
905845	1/2" F - Ø 15	25	-
905846	1/2" F - Ø 16	25	-
905848	1/2" F - Ø 18	25	-
905856	3/4" F - Ø 16	25	-
905858	3/4" F - Ø 18	25	-
905852	3/4" F - Ø 22	25	-

9067



Male tee fitting. For annealed copper, hard copper, brass, mild steel and stainless steel. According to EN 1254-4 standard. **For hydraulic and domestic water systems:** black O-Ring according to EN 681.1 standard. Max. working pressure: 16 bar. Temperature range: -25–120°C.

Code



906740	1/2" M - Ø 10	25	-
906742	1/2" M - Ø 12	25	-
906744	1/2" M - Ø 14	25	-
906745	1/2" M - Ø 15	25	-
906746	1/2" M - Ø 16	25	-
906758	3/4" M - Ø 18	25	-
906752	3/4" M - Ø 22	20	-

MECHANICAL FITTINGS WITH O-RING SEAL

9068

Female tee fitting. For annealed copper, hard copper, brass, mild steel and stainless steel. According to EN 1254-4 standard.

For hydraulic and domestic water systems: black O-Ring according to EN 681.1 standard. Max. working pressure: 16 bar. Temperature range: -25-120°C.



Code			
906830	3/8" F - Ø 10	25	-
906832	3/8" F - Ø 12	25	-
906840	1/2" F - Ø 10	25	-
906842	1/2" F - Ø 12	25	-
906844	1/2" F - Ø 14	25	-
906845	1/2" F - Ø 15	25	-
906846	1/2" F - Ø 16	25	-
906858	3/4" F - Ø 18	25	-
906852	3/4" F - Ø 22	20	-

910

Female fitting. Chrome plated. For annealed copper, hard copper, brass, mild steel and stainless steel.

According to EN 1254-4 standard. **For hydraulic and domestic water systems:** black O-Ring according to EN 681.1 standard. Max. working pressure: 16 bar. Temperature range: -25-120°C.



Code			
910310	3/8" F - Ø 10	50	-
910312	3/8" F - Ø 12	50	-
910314	3/8" F - Ø 14	50	-
910410	1/2" F - Ø 10	50	-
910412	1/2" F - Ø 12	50	-
910414	1/2" F - Ø 14	50	-
910415	1/2" F - Ø 15	50	-

914

Male fitting. Chrome plated. For annealed copper, hard copper, brass, mild steel and stainless steel.

According to EN 1254-4 standard. **For hydraulic and domestic water systems:** black O-Ring according to EN 681.1 standard. Max. working pressure: 16 bar. Temperature range: -25-120°C.



Code			
914310	3/8" M - Ø 10	50	-
914312	3/8" M - Ø 12	50	-
914314	3/8" M - Ø 14	50	-
914410	1/2" M - Ø 10	50	-
914412	1/2" M - Ø 12	50	-
914414	1/2" M - Ø 14	50	-
914415	1/2" M - Ø 15	50	-

930



Elbow fitting with wall connection. For annealed copper, hard copper, brass, mild steel and stainless steel. According to EN 1254-4 standard. With double O-Ring.

For gas and fluid hydrocarbons: yellow O-Ring according to EN 549 standard. Temperature range: -20-100°C. **For hydraulic and domestic water systems:** black O-Ring according to EN 681.1 standard. Max. working pressure: 16 bar. Temperature range: -25-120°C.

Code			
930412	1/2" F - Ø 12	25	-
930414	1/2" F - Ø 14	25	-
930416	1/2" F - Ø 16	25	-

913

Coupling sleeve. Chrome plated. For annealed copper, hard copper, brass, mild steel and stainless steel.

According to EN 1254-2 standard. **For hydraulic and domestic water systems:** black O-Ring according to EN 681.1 standard. Max. working pressure: 16 bar. Temperature range: -25-120°C.



Code			
913010	Ø 10	50	-
913012	Ø 12	50	-
913014	Ø 14	50	-

Mechanical fittings with O-Ring seal are not suitable for use with fuel added with RME (Rape Methyl Ester).

DECA-FITTINGS FOR POLYETHYLENE PIPES



860

tech. broch. 01037

Female fitting.
In brass.
For polyethylene pipes.
Max. working pressure: 16 bar.
Max. working temperature: 40°C.



Code			
860420	Ø 20 x 1/2" F	12	60
860421	Ø 21 x 1/2" F	12	60
860525	Ø 25 x 3/4" F	10	50
860527	Ø 27 x 3/4" F	10	50
860625	Ø 25 x 1" F	10	60
860632	Ø 32 x 1" F	10	50
860634	Ø 34 x 1" F	10	50
860740	Ø 40 x 1 1/4" F	10	50
860850	Ø 50 x 1 1/2" F	5	25
860963	Ø 63 x 2" F	8	-



861

tech. broch. 01037

Male fitting.
In brass.
For polyethylene pipes.
Max. working pressure: 16 bar.
Max. working temperature: 40°C.



Code			
861420	Ø 20 x 1/2" M	12	60
861421	Ø 21 x 1/2" M	12	60
861525	Ø 25 x 3/4" M	10	50
861527	Ø 27 x 3/4" M	10	50
861625	Ø 25 x 1" M	10	60
861632	Ø 32 x 1" M	10	50
861634	Ø 34 x 1" M	10	50
861740	Ø 40 x 1 1/4" M	10	50
861850	Ø 50 x 1 1/2" M	5	25
861963	Ø 63 x 2" M	8	-



860

tech. broch. 01037

Female fitting.
In cast iron.
Stainless steel rods.
For polyethylene pipes.
Max. working pressure: 10 bar.
Max. working temperature: 40°C.

Code			
860075	Ø 75 x 2 1/2" F	1	-
860090	Ø 90 x 3" F	1	-
860110	Ø 110 x 4" F	1	-



861

tech. broch. 01037

Male fitting.
In cast iron.
Stainless steel rods.
For polyethylene pipes.
Max. working pressure: 10 bar.
Max. working temperature: 40°C.

Code			
861075	Ø 75 x 2 1/2" M	1	-
861090	Ø 90 x 3" M	1	-
861110	Ø 110 x 4" M	1	-



875

tech. broch. 01037

Reduced female fitting.
In brass.
For polyethylene pipes.
Max. working pressure: 16 bar.
Max. working temperature: 40°C.



Code			
875425	Ø 25 x 1/2" F	10	50
875532	Ø 32 x 3/4" F	10	50
875640	Ø 40 x 1" F	10	50



876

tech. broch. 01037

Female fitting with union.
In brass.
For polyethylene pipes.
Max. working pressure: 16 bar.
Max. working temperature: 40°C.



Code			
876520	Ø 20 x 3/4"	15	75
876525	Ø 25 x 3/4"	12	60
876625	Ø 25 x 1"	12	60
876632	Ø 32 x 1"	10	50

DECA-FITTINGS FOR POLYETHYLENE PIPES



862

tech. broch. 01037

Reduced male fitting.
In brass.
For polyethylene pipes.
Max. working pressure: 16 bar.
Max. working temperature: 40°C.



Code			
862320	Ø 20 x 3/8" M	12	60
862425	Ø 25 x 1/2" M	10	50
862532	Ø 32 x 3/4" M	10	50
862640	Ø 40 x 1" M	10	50
862750	Ø 50 x 1 1/4" M	5	25
862863	Ø 63 x 1 1/2" M	8	-



863

tech. broch. 01037

Sleeve fitting.
In cast iron.
Stainless steel rods.
For polyethylene pipes.
Max. working pressure: 10 bar.
Max. working temperature: 40°C.

Code			
863075	Ø 75	1	-
863090	Ø 90	1	-
863110	Ø 110	1	-
863125	Ø 125	1	-



888

tech. broch. 01037

Flanged fitting,
PN 10 UNI 2277 series.
In cast iron.
Stainless steel rods.
For polyethylene pipes.
Max. working pressure: 10 bar.
Max. working temperature: 40°C.

Code			
888075	Ø 75 x DN 65	1	-
888090	Ø 90 x DN 80	1	-
888110	Ø 110 x DN 100	1	-
888125	Ø 125 x DN 100	1	-



864

tech. broch. 01037

Tee fitting.
In brass.
For polyethylene pipes.
Max. working pressure: 16 bar.
Max. working temperature: 40°C.



Code			
864020	Ø 20	10	50
864021	Ø 21	10	50
864025	Ø 25	10	50
864027	Ø 27	5	25
864032	Ø 32	5	25
864034	Ø 34	4	20
864040	Ø 40	5	-
864050	Ø 50	5	-
864063	Ø 63	5	-



863

tech. broch. 01037

Sleeve fitting.
In brass.
For polyethylene pipes.
Max. working pressure: 16 bar.
Max. working temperature: 40°C.



Code			
863020	Ø 20	15	75
863021	Ø 21	15	75
863025	Ø 25	12	60
863027	Ø 27	10	50
863032	Ø 32	10	50
863034	Ø 34	5	25
863040	Ø 40	5	25
863050	Ø 50	5	25
863063	Ø 63	6	-



865

tech. broch. 01037

Reduced male-female tee fitting.
In brass.
For polyethylene pipes.
Max. working pressure: 16 bar.
Max. working temperature: 40°C.



Code			
865420	Ø 20 x 1/2" M x 3/8" F	10	50
865525	Ø 25 x 3/4" M x 1/2" F	10	50
865632	Ø 32 x 1" M x 3/4" F	5	25
865740	Ø 40 x 1 1/4" M x 1" F	5	-
865850	Ø 50 x 1 1/2" M x 1 1/4" F	5	-
865963	Ø 63 x 2" M x 1 1/2" F	5	-

DECA-FITTINGS FOR POLYETHYLENE PIPES



866

tech. broch. 01037

Elbow fitting.
In brass.
For polyethylene pipes.
Max. working pressure: 16 bar.
Max. working temperature: 40°C.



Code

Code	Ø	10	50
866020	Ø 20	10	50
866025	Ø 25	10	50
866032	Ø 32	5	25
866040	Ø 40	4	20
866050	Ø 50	3	15
866063	Ø 63	5	–



869

tech. broch. 01037

Female elbow fitting
with wall connections.
In brass.
For polyethylene pipes.
Max. working pressure: 16 bar.
Max. working temperature: 40°C.



Code

Code	Ø	5	25
869420	Ø 20 x 1/2" F	5	25
869425	Ø 25 x 1/2" F	4	20
869525	Ø 25 x 3/4" F	4	20



867

tech. broch. 01037

Male elbow fitting.
In brass.
For polyethylene pipes.
Max. working pressure: 16 bar.
Max. working temperature: 40°C.



Code

Code	Ø	10	50
867420	Ø 20 x 1/2" M	10	50
867525	Ø 25 x 3/4" M	10	50
867632	Ø 32 x 1" M	10	50
867740	Ø 40 x 1 1/4" M	4	20
867850	Ø 50 x 1 1/2" M	4	20
867963	Ø 63 x 2" M	5	–

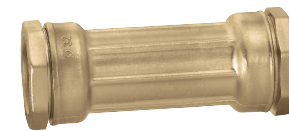

870

tech. broch. 01037

Long sleeve fitting.
Can be used for pipe repairs.
In brass.
For polyethylene pipes.

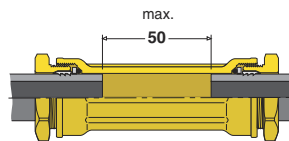

Allows pipe repairs
with a maximum distance of 50 mm
between pipe ends.

Max. working pressure: 16 bar.
Max. working temperature: 40°C.



Code

Code	Ø	10	50
870025	Ø 25	10	50
870032	Ø 32	5	25
870040	Ø 40	4	20
870050	Ø 50	3	15



868

tech. broch. 01037

Female elbow fitting.
In brass.
For polyethylene pipes.
Max. working pressure: 16 bar.
Max. working temperature: 40°C.



Code

Code	Ø	10	50
868420	Ø 20 x 1/2" F	10	50
868525	Ø 25 x 3/4" F	10	50
868632	Ø 32 x 1" F	10	50
868740	Ø 40 x 1 1/4" F	4	20
868850	Ø 50 x 1 1/2" F	4	20
868963	Ø 63 x 2" F	5	–



871

tech. broch. 01037

Fitting with ball valve.
In brass.
For polyethylene pipes.
Max. working pressure: 16 bar.
Max. working temperature: 40°C.

Code

Code	Ø	10	50
871425	Ø 25 x 1/2" F	10	50
871525	Ø 25 x 3/4" F	5	25
871532	Ø 32 x 3/4" F	5	25

DEZINCIFICATION RESISTANT ALLOY FITTINGS FOR POLYETHYLENE PIPES



960

Female fitting.
In CR dezincification resistant alloy.
For polyethylene pipes.
Max. working pressure: 16 bar.
Max. working temperature: 40°C.



Code

960420 SAV	Ø 20 x 1/2" F	12	60
960525 SAV	Ø 25 x 3/4" F	10	50
960625 SAV	Ø 25 x 1" F	10	60
960632 SAV	Ø 32 x 1" F	10	50
960740 SAV	Ø 40 x 1 1/4" F	6	30
960850 SAV	Ø 50 x 1 1/2" F	5	20
960963 SAV	Ø 63 x 2" F	8	-



962

Reduced male fitting.
In CR dezincification resistant alloy.
For polyethylene pipes.
Max. working pressure: 16 bar.
Max. working temperature: 40°C.



Code

962532 SAV	Ø 32 x 3/4" M	10	50
962640 SAV	Ø 40 x 1" M	6	30



975

Reduced female fitting.
In CR dezincification resistant alloy.
For polyethylene pipes.
Max. working pressure: 16 bar.
Max. working temperature: 40°C.



Code

975532 SAV	Ø 32 x 3/4" F	10	50
975640 SAV	Ø 40 x 1" F	6	30
975732 SAV	Ø 32 x 1 1/4" F	6	30
975750 SAV	Ø 50 x 1 1/4" F	5	20



963

Sleeve fitting.
In CR dezincification resistant alloy.
For polyethylene pipes.
Max. working pressure: 16 bar.
Max. working temperature: 40°C.



Code

963020 SAV	Ø 20	15	75
963025 SAV	Ø 25	12	60
963032 SAV	Ø 32	10	50
963040 SAV	Ø 40	5	20
963050 SAV	Ø 50	6	-
963063 SAV	Ø 63	5	-



961

Male fitting.
In CR dezincification resistant alloy.
For polyethylene pipes.
Max. working pressure: 16 bar.
Max. working temperature: 40°C.



Code

961420 SAV	Ø 20 x 1/2" M	12	60
961520 SAV	Ø 20 x 3/4" M	12	60
961525 SAV	Ø 25 x 3/4" M	10	50
961625 SAV	Ø 25 x 1" M	10	60
961632 SAV	Ø 32 x 1" M	10	50
961732 SAV	Ø 32 x 1 1/4" M	10	50
961740 SAV	Ø 40 x 1 1/4" M	6	30
961840 SAV	Ø 40 x 1 1/2" M	6	30
961850 SAV	Ø 50 x 1 1/2" M	5	20
961950 SAV	Ø 50 x 2" M	5	20
961963 SAV	Ø 63 x 2" M	8	-



964

Tee fitting.
In CR dezincification resistant alloy.
For polyethylene pipes.
Max. working pressure: 16 bar.
Max. working temperature: 40°C.



Code

964020 SAV	Ø 20	10	50
964025 SAV	Ø 25	10	50
964032 SAV	Ø 32	5	25
964040 SAV	Ø 40	5	-
964050 SAV	Ø 50	5	-

DEZINCIFICATION RESISTANT ALLOY FITTINGS FOR POLYETHYLENE PIPES



966

Elbow fitting.
In CR dezincification resistant alloy.
For polyethylene pipes.
Max. working pressure: 16 bar.
Max. working temperature: 40°C.



Code

966025 SAV	Ø 25	10	50
966032 SAV	Ø 32	5	25
966040 SAV	Ø 40	3	15



970

Long sleeve fitting.
In CR dezincification resistant alloy.
For polyethylene pipes.

Allows pipe repairs with a maximum distance of 50 mm between pipe ends.

Max. working pressure: 16 bar.
Max. working temperature: 40°C.

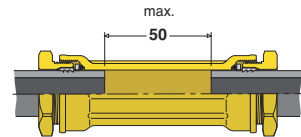

Code

970032 SAV	Ø 32	5	25
970040 SAV	Ø 40	5	-
970050 SAV	Ø 50	4	-



967

Male elbow fitting.
In CR dezincification resistant alloy.
For polyethylene pipes.
Max. working pressure: 16 bar.
Max. working temperature: 40°C.



Code

967632 SAV	Ø 32 x 1" M	10	50
------------	-------------	----	----

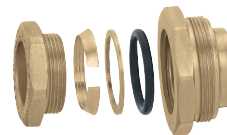

986

Reduction kit.



Code

986032 SAV	from Ø 32 to Ø 25	12	60
986043 SAV	from Ø 40 to Ø 32	10	50
986053 SAV	from Ø 50 to Ø 32	6	30
986054 SAV	from Ø 50 to Ø 40	6	30



968

Female elbow fitting.
In CR dezincification resistant alloy.
For polyethylene pipes.
Max. working pressure: 16 bar.
Max. working temperature: 40°C.



Code

968632 SAV	Ø 32 x 1" F	10	50
968740 SAV	Ø 40 x 1 1/4" F	4	20

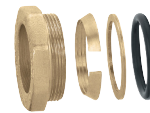

980

Kit.

Code

980025 SAV	Ø 25	100	-
980032 SAV	Ø 32	100	-
980040 SAV	Ø 40	50	-
980050 SAV	Ø 50	50	-
980063 SAV	Ø 63	50	-

DECA-FITTINGS FOR STEEL PIPES

Steel series

For steel pipes with nominal outer diameters for gas threading. Stainless steel pipe clenching ring.



890

Female fitting. In brass.
For steel pipe.
Max. working pressure: 16 bar.
Max. working temperature: 40°C.



Code			
890421	Ø 21 x 1/2" F	12	60
890527	Ø 27 x 3/4" F	10	50
890634	Ø 34 x 1" F	10	50



891

Male fitting. In brass.
For steel pipe.
Max. working pressure: 16 bar.
Max. working temperature: 40°C.



Code			
891421	Ø 21 x 1/2" M	12	60
891527	Ø 27 x 3/4" M	10	50
891634	Ø 34 x 1" M	10	50



893

Sleeve fitting. In brass.
For steel pipe.
Without internal stop to be used as joint repair sleeve.

Can be used for pipe repair with a maximum distance of 15 mm between pipe ends.

Max. working pressure: 16 bar.
Max. working temperature: 40°C.

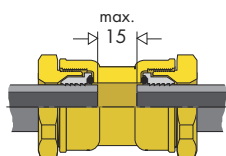

Code			
893021	Ø 21	15	75
893027	Ø 27	10	50
893034	Ø 34	5	25



894

Tee fitting. In brass.
For steel pipe.
Max. working pressure: 16 bar.
Max. working temperature: 40°C.



Code			
894021	Ø 21	10	50
894027	Ø 27	5	25
894034	Ø 34	4	20

Example of use on steel pipes

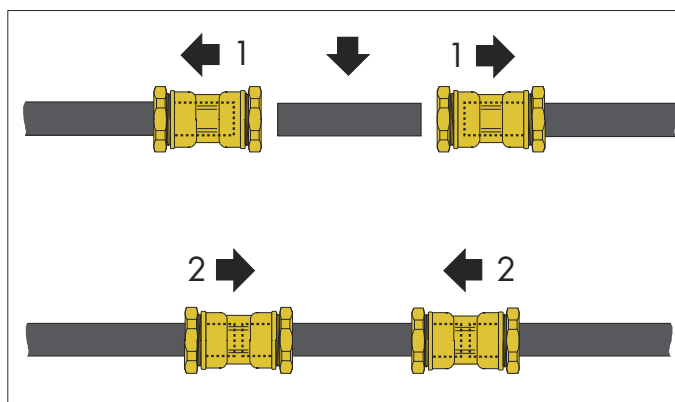

Example of repair with the insertion of a supplementary sleeve.

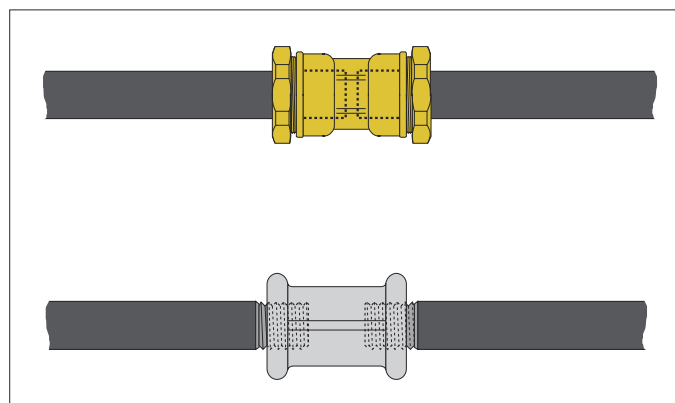

In order to avoid corrosion, which is typical when traditional threaded sleeves are used (see diagram in grey colour), the application of the **Steel** series fittings (see diagram in yellow colour) allows piping to keep the complete galvanisation.

The traditional sleeve in fact does not cover the entire threaded part which is therefore subjected to high corrosion since it features no galvanisation and is weakened on the diameter.

ACCESSORIES AND SPARE PARTS FOR DECA-FITTINGS



886
Reduction kit.



Code			
886022	from Ø 25 to Ø 20	1	–
886032	from Ø 32 to Ø 25	1	–
886043	from Ø 40 to Ø 32	1	–
886054	from Ø 50 to Ø 40	1	–
886065	from Ø 63 to Ø 50	1	–



887
Pipe stiffener.



PN 10 series

Code			
887120	20 x 2	10	–
887223	25 x 2,3	10	–
887330	32 x 3	10	–
887437	40 x 3,7	5	–
887546	50 x 4,6	5	–
887658	63 x 5,8	5	–

For REHAU pipes

Code			
887128	20 x 2,8	10	–
887235	25 x 3,5	10	–

S 5 PN 4 series

Code			
887130	20 x 3	10	–
887230	25 x 3	10	–
887330	32 x 3	10	–
887437	40 x 3,7	5	–
887546	50 x 4,6	5	–
887658	63 x 5,8	5	–

S 8 PN 2,5–4 series

Code			
887430	40 x 3	5	–
887530	50 x 3	5	–
887636	63 x 3,6	5	–



877
Pipe clenching ring.

Code			
877020	Ø 20 brass	1	–
877021	Ø 21 brass	1	–
877121	Ø 21 stainless steel	1	–
877025	Ø 25 brass	1	–
877027	Ø 27 brass	1	–
877127	Ø 27 stainless steel	1	–
877032	Ø 32 brass	1	–
877034	Ø 34 brass	1	–
877134	Ø 34 stainless steel	1	–
877040	Ø 40 brass	1	–
877050	Ø 50 brass	1	–
877063	Ø 63 brass	1	–



878
Brass washer.

Code			
878020	Ø 20	1	–
878021	Ø 21	1	–
878025	Ø 25	1	–
878027	Ø 27	1	–
878032	Ø 32	1	–
878034	Ø 34	1	–
878040	Ø 40	1	–
878050	Ø 50	1	–
878063	Ø 63	1	–



879
O-Ring.

Code			
879020	Ø 20	1	–
879021	Ø 21	1	–
879025	Ø 25	1	–
879027	Ø 27	1	–
879032	Ø 32	1	–
879034	Ø 34	1	–
879040	Ø 40	1	–
879050	Ø 50	1	–
879063	Ø 63	1	–

GAS SAFETY

This diagram is just an indication

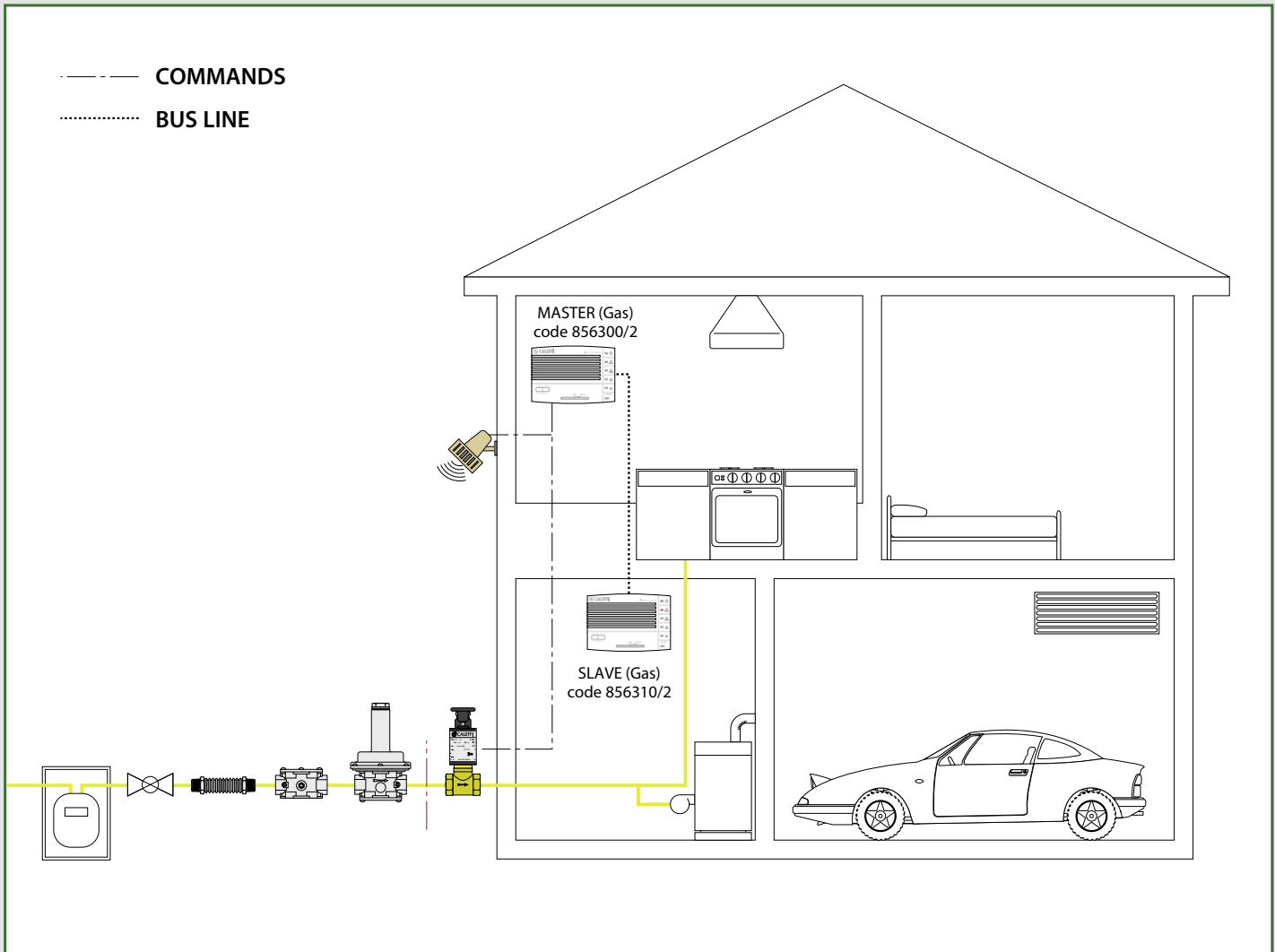

- Gas filters
- Gas pressure filter regulators
- Gas pressure regulators
- Antivibration extendible joints for gas systems
- Pressure gauge for gas
- Solenoid valves for gas
- Gas detectors



847

Compact gas filter.
Max. pressure: 2 bar.
Filtration: $\varnothing \geq 50 \mu\text{m}$.
Filtration class: G 2 (to EN 779).



Code

Code	Size	Green Box	Yellow Box
847004	1/2"	1	-
847005	3/4"	1	-



848

Gas filter.
Max. pressure: 2 bar.
Filtration: $\varnothing \geq 50 \mu\text{m}$.
Filtration class: G 2 (to EN 779).



Code

Code	Size	Green Box	Yellow Box
848004	1/2"	1	-
848005	3/4"	1	-
848006	1"	1	-
848007	1 1/4"	1	-
848008	1 1/2"	1	-
848009	2"	1	-



848

Gas filter.
Body PN 16.
Flanged connection.
To be coupled with flat counterflanges EN 1092-1.
Max. pressure: 2 bar.
Filtration: $\varnothing \geq 50 \mu\text{m}$.
Filtration class: G 2 (to EN 779).



Code

Code	Size	Green Box	Yellow Box
848060	DN 65	1	-
848080	DN 80	1	-
848100	DN 100	1	-



850

Gas pressure closing filter regulator, double diaphragm.
Threaded connections.
Max. inlet pressure: 500 mbar.
Temperature range: -15–60°C.
Regulation and closing at null flow according to UNI EN 88.
Filtration: $\varnothing \geq 50 \mu\text{m}$.
Filtration class: G 2 (to EN 779).
Conformity to Directive ATEX (II 2G - II 2D).



Code

Code	Size	Adjustment (mbar)	Green Box	Yellow Box
850004	1/2"	18–40	1	-
850005	3/4"	18–40	1	-
850006	1"	18–40	1	-
850007	1 1/4"	13–23	1	-
850008	1 1/2"	13–23	1	-
850009	2"	13–23	1	-



850

Gas pressure closing filter regulator, double diaphragm.
Body PN 16.
Flanged connection. To be coupled with flat counterflanges EN 1092-1.
Max. inlet pressure: 500 mbar.
Temperature range: -15–60°C.
Regulation and closing at null flow according to UNI EN 88.
Filtration: $\varnothing \geq 50 \mu\text{m}$.
Filtration class: G 2 (to EN 779).
Conformity to Directive ATEX (II 2G - II 2D).



Code

Code	Size	Adjustment (mbar)	Green Box	Yellow Box
850060	DN 65	13–27	1	-
850080	DN 80	13–27	1	-
850100	DN 100	15–27	1	-





852

Gas pressure closing regulator, double diaphragm. Threaded connections. Max. inlet pressure: 500 mbar. Temperature range: -15–60°C. Regulation and closing at null flow according to UNI EN 88. Conformity to Directive ATEX (II 2G - II 2D).



Code		Adjustment (mbar)		
852004	1/2"	18–40	1	–
852005	3/4"	18–40	1	–
852006	1"	18–40	1	–
852007	1 1/4"	13–23	1	–
852008	1 1/2"	13–23	1	–
852009	2"	13–23	1	–



852

Gas pressure closing regulator, double diaphragm. Body PN 16. Flanged connection. To be coupled with flat counterflanges EN 1092-1. Max. inlet pressure: 500 mbar. Temperature range: -15–60°C. Regulation and closing at null flow according to UNI EN 88. Conformity to Directive ATEX (II 2G - II 2D).



Code		Adjustment (mbar)		
852060	DN 65	13–27	1	–
852080	DN 80	13–27	1	–
852100	DN 100	15–27	1	–



841

Extendible stainless steel joint according to UNI 11353, for gas systems in domestic applications (max. 35 kW). Max. working pressure PS: 0,5 bar. Fixed male connection: AISI 303. Flexible: AISI 316L. Captive female connection: AISI 303.

Code		Min./max. L		
841414	1/2"	90/130	3	–
841514	3/4"	90/130	3	–
841614	1"	90/130	3	–
841420	1/2"	120/210	3	–
841520	3/4"	120/210	3	–
841620	1"	120/210	3	–
841440	1/2"	240/410	3	–
841540	3/4"	240/410	3	–
841640	1"	240/410	3	–



842

Antivibration joint for gas systems. According to EN 676 standard. Max. working pressure PS: 0,5 bar.

Threaded version: body AISI 316L, fixed male connection: FE 37.

Flanged version: body AISI 321, free flanged connections: ASTM A 105 - PN 10. To be coupled with flat counterflanges EN 1092-1 (PN 10 - PN 16).

Code		L (mm)		
842004	1/2"	145	3	–
842005	3/4"	150	3	–
842006	1"	165	3	–
842007	1 1/4"	180	1	–
842008	1 1/2"	210	1	–
842009	2"	230	1	–
842060	DN 65	175	1	–
842080	DN 80	175	1	–
842100	DN 100	195	1	–



8460

Tap for gas pressure gauge, with opening button. Female connections.

Code			
846002	1/4"	1	–
846003	3/8"	1	–



8461

Pressure gauge for gas. Diaphragm precision sensitive element. Bottom connection. Accuracy: UNI 1,6.

Code		mbar	Ø		
846101	1/4"	0–60	60	1	–
846102	1/4"	0–100	60	1	–
846103	3/8"	0–60	80	1	–
846104	3/8"	0–100	80	1	–

SOLENOID VALVES FOR GAS - NORMALLY OPEN - MANUAL RESET



8540

Solenoid valve for gas, normally open, with manual reset. Max. pressure: 500 mbar. Protection class: IP 65. Conformity to Directive ATEX (II 3G - II 3D).



Code	Electric supply			
854024	1/2"	230 V (ac)	1	-
854025	3/4"	230 V (ac)	1	-
854044	1/2"	24 V (ac)	1	-
854045	3/4"	24 V (ac)	1	-

Spare coil, complete with connector.

Code	Electric supply	Use		
854012	230 V (ac)	1/2" - 3/4"	1	-
854014	24 V (ac)	1/2" - 3/4"	1	-

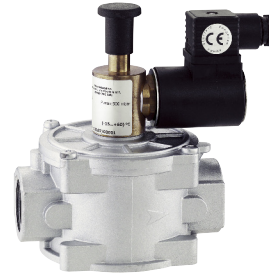

839

Solenoid valve for gas, normally open, with manual reset. Max. pressure: 500 mbar. Protection class: IP 65. Conformity to Directive ATEX (II 3G - II 3D).



Code	Electric supply			
839005	3/4"	230 V (ac)	1	-
839006	1"	230 V (ac)	1	-
839007	1 1/4"	230 V (ac)	1	-
839008	1 1/2"	230 V (ac)	1	-
839009	2"	230 V (ac)	1	-
839105	3/4"	24 V (ac)	1	-
839106	1"	24 V (ac)	1	-
839107	1 1/4"	24 V (ac)	1	-
839108	1 1/2"	24 V (ac)	1	-
839109	2"	24 V (ac)	1	-
839205	3/4"	12 V (dc)	1	-
839206	1"	12 V (dc)	1	-
839207	1 1/4"	12 V (dc)	1	-
839208	1 1/2"	12 V (dc)	1	-
839209	2"	12 V (dc)	1	-



8540

Solenoid valve for gas, normally open, with manual reset. Max. pressure: 500 mbar. Protection class: IP 65. Conformity to Directive ATEX (II 3G - II 3D).



Code	Electric supply			
854026	1"	230 V (ac)	1	-
854046	1"	24 V (ac)	1	-

Spare coil, complete with connector.

Code	Electric supply	Use		
854002	230 V (ac)	1"	1	-
854004	24 V (ac)	1"	1	-

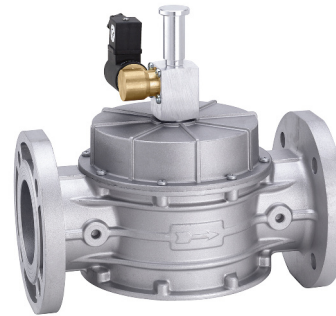

839

Solenoid valve for gas, normally open, with manual reset. Body PN 16. Max. pressure: 500 mbar. Protection class: IP 65. Conformity to Directive ATEX (II 3G - II 3D).

Flanged connections PN 16. To be coupled with flat counterflanges EN 1092-1.



Code	Electric supply			
839060	DN 65	230 V (ac)	1	-
839080	DN 80	230 V (ac)	1	-
839100	DN 100	230 V (ac)	1	-
839120	DN 125	230 V (ac)	1	-
839150	DN 150	230 V (ac)	1	-
839160	DN 65	24 V (ac)	1	-
839180	DN 80	24 V (ac)	1	-
839190	DN 100	24 V (ac)	1	-
839220	DN 125	24 V (ac)	1	-
839250	DN 150	24 V (ac)	1	-

Spare coil, complete with connector.

Code	Electric supply	Use		
839A05	230 V (ac)	3/4"-DN 150	1	-
839B05	24 V (ac)	3/4"-DN 150	1	-
839C05	12 V (dc)	3/4"-DN 150	1	-

SOLENOID VALVES FOR GAS - NORMALLY CLOSED - MANUAL RESET



8541

Solenoid valve for gas, normally closed, with manual reset. Max. pressure: 500 mbar. Class A - Group 2. Protection class: IP 65. Standards: EN 161 - Directive ATEX (II 3G - II 3D).



Code	Electric supply			
854124	1/2"	230 V (ac)	1	-
854125	3/4"	230 V (ac)	1	-
854126	1"	230 V (ac)	1	-
854144	1/2"	24 V (ac)	1	-
854145	3/4"	24 V (ac)	1	-
854146	1"	24 V (ac)	1	-

Spare coil, complete with connector.

Code	Electric supply	Use		
854102	230 V (ac)	1/2"-1"	1	-
854104	24 V (ac)	1/2"-1"	1	-



837

Solenoid valve for gas, normally closed, with manual reset. Max. pressure: 500 mbar. Class A - Group 2. Protection class: IP 65. Standards: EN 161 - Directive ATEX (II 3G - II 3D).



Code	Electric supply			
837005	3/4"	230 V (ac)	1	-
837006	1"	230 V (ac)	1	-
837007	1 1/4"	230 V (ac)	1	-
837008	1 1/2"	230 V (ac)	1	-
837009	2"	230 V (ac)	1	-
837105	3/4"	24 V (ac)	1	-
837106	1"	24 V (ac)	1	-
837107	1 1/4"	24 V (ac)	1	-
837108	1 1/2"	24 V (ac)	1	-
837109	2"	24 V (ac)	1	-
837205	3/4"	12 V (dc)	1	-
837206	1"	12 V (dc)	1	-
837207	1 1/4"	12 V (dc)	1	-
837208	1 1/2"	12 V (dc)	1	-
837209	2"	12 V (dc)	1	-

Spare coil, complete with connector.

Code	Electric supply	Use		
837A05	230 V (ac)	3/4"-2"	1	-
837B05	24 V (ac)	3/4"-2"	1	-
837C05	12 V (dc)	3/4"-2"	1	-



837

Solenoid valve for gas, normally closed, with manual reset. Body PN 16. Max. pressure: 500 mbar. Class A - Group 2. Protection class: IP 65. Standards: EN 161 - Directive ATEX (II 3G - II 3D).



Flanged connections PN 16. To be coupled with flat counterflanges EN 1092-1.

Code	Electric supply			
837060	DN 65	230 V (ac)	1	-
837080	DN 80	230 V (ac)	1	-
837100	DN 100	230 V (ac)	1	-
837120	DN 125	230 V (ac)	1	-
837150	DN 150	230 V (ac)	1	-
837160	DN 65	24 V (ac)	1	-
837180	DN 80	24 V (ac)	1	-
837190	DN 100	24 V (ac)	1	-
837220	DN 125	24 V (ac)	1	-
837250	DN 150	24 V (ac)	1	-

Spare coil, complete with connector.

Code	Electric supply	Use		
837A60	230 V (ac)	DN 65-DN 150	1	-
837B60	24 V (ac)	DN 65-DN 150	1	-

SOLENOID VALVES FOR GAS - NORMALLY CLOSED



838

Solenoid valve for gas, normally closed.
Max. pressure: 360 mbar.
Class A - Group 2.
Protection class: IP 65.
Standards: EN 161 - Directive ATEX (II 3G - II 3D).



Code	Electric supply			
838004	1/2"	230 V (ac)	1	-
838005	3/4"	230 V (ac)	1	-
838006	1"	230 V (ac)	1	-
838007*	1 1/4"	230 V (ac)	1	-
838008*	1 1/2"	230 V (ac)	1	-
838009*	2"	230 V (ac)	1	-
838104	1/2"	24 V (ac)	1	-
838105	3/4"	24 V (ac)	1	-
838106	1"	24 V (ac)	1	-
838107*	1 1/4"	24 V (ac)	1	-
838108*	1 1/2"	24 V (ac)	1	-
838109*	2"	24 V (ac)	1	-

* With upper hexagonal fixing nut

Spare coil, complete with connector.

Code	Electric supply	Use		
838A04	230 V (ac)	1/2" - 3/4" (round version)	1	-
838A14	230 V (ac)	1/2" - 3/4" (square version)	1	-
838A06	230 V (ac)	1" (round version)	1	-
838A07	230 V (ac)	1 1/4"-2" (round version)	1	-
838A17	230 V (ac)	1 1/4"-2" (round version)*	1	-
838B04	24 V (ac)	1/2" - 3/4" (round version)	1	-
838B14	24 V (ac)	1/2" - 3/4" (square version)	1	-
838B06	24 V (ac)	1" (round version)	1	-
838B07	24 V (ac)	1 1/4"-2" (round version)	1	-
838B17	24 V (ac)	1 1/4"-2" (round version)*	1	-

* With upper hexagonal fixing nut



838

Solenoid valve for gas, normally closed.
Body PN 16.
Max. pressure: 200 mbar.
Class A - Group 2.
Protection class: IP 65.
Standards: EN 161 - Directive ATEX (II 3G - II 3D).

Flanged connections PN 16.
To be coupled with flat counterflanges EN 1092-1.



Code	Electric supply			
838060	DN 65	230 V (ac)	1	-
838080	DN 80	230 V (ac)	1	-
838100	DN 100	230 V (ac)	1	-
838120	DN 125	230 V (ac)	1	-
838150	DN 150	230 V (ac)	1	-
838160	DN 65	24 V (ac)	1	-
838180	DN 80	24 V (ac)	1	-
838190	DN 100	24 V (ac)	1	-
838220	DN 125	24 V (ac)	1	-
838250	DN 150	24 V (ac)	1	-

Spare coil, complete with connector.

Code	Electric supply	Use		
838A60	230 V (ac)	DN 65 - DN 80	1	-
838A00	230 V (ac)	DN 100	1	-
838A20	230 V (ac)	DN 125 - DN 150	1	-
838B60	24 V (ac)	DN 65 - DN 80	1	-
838B00	24 V (ac)	DN 100	1	-
838B20	24 V (ac)	DN 125 - DN 150	1	-

ROTATING SIREN - BLINKER



8561

Rotating siren.
230 V (ac) - 112 dB/1 m.



Code		
856102	1	-



8562

Electronic intermittence blinker.
230 V (ac) - Lamp power: 40 W.



Code		
856202	1	-

GAS DETECTORS



8563

Gas detector, with built-in sensor and relay outlet.
With BUS connection, for auxiliary remote sensor.
For solenoid valves 8540, 8541, 837, 838 and 839 series.
Supply: 230 V (ac).
Outlet contact: 8 (2) A.
Protection class: IP 42.



Code



856300	for methane gas	1	-
856302	for LPG	1	-



855

Gas detector, with built-in sensor and relay outlet.
Without BUS connection.
With solenoid valve.
Normally open.
Supply: 230 V (ac).
Protection class: IP 42.



Code



855400	1/2"	for methane gas	1	-
855500	3/4"	for methane gas	1	-
855410	1/2"	for LPG	1	-
855510	3/4"	for LPG	1	-



8563

Auxiliary remote sensor for gas detector 8563 series.
Supply: 230 V (ac).
Protection class: IP 42.



Code



856310	for methane gas	1	-
856312	for LPG	1	-



8565

Gas detector, with built-in sensor and relay outlet.
Without BUS connection.
Supply: 230 V (ac).
Outlet contact: 8 (2) A.
Protection class: IP 42.



Code



856500	for methane gas	1	-
856502	for LPG	1	-

EXPANSION VESSELS, MIXING VALVES, CHRONO-THERMOSTATS

This diagram is just an indication

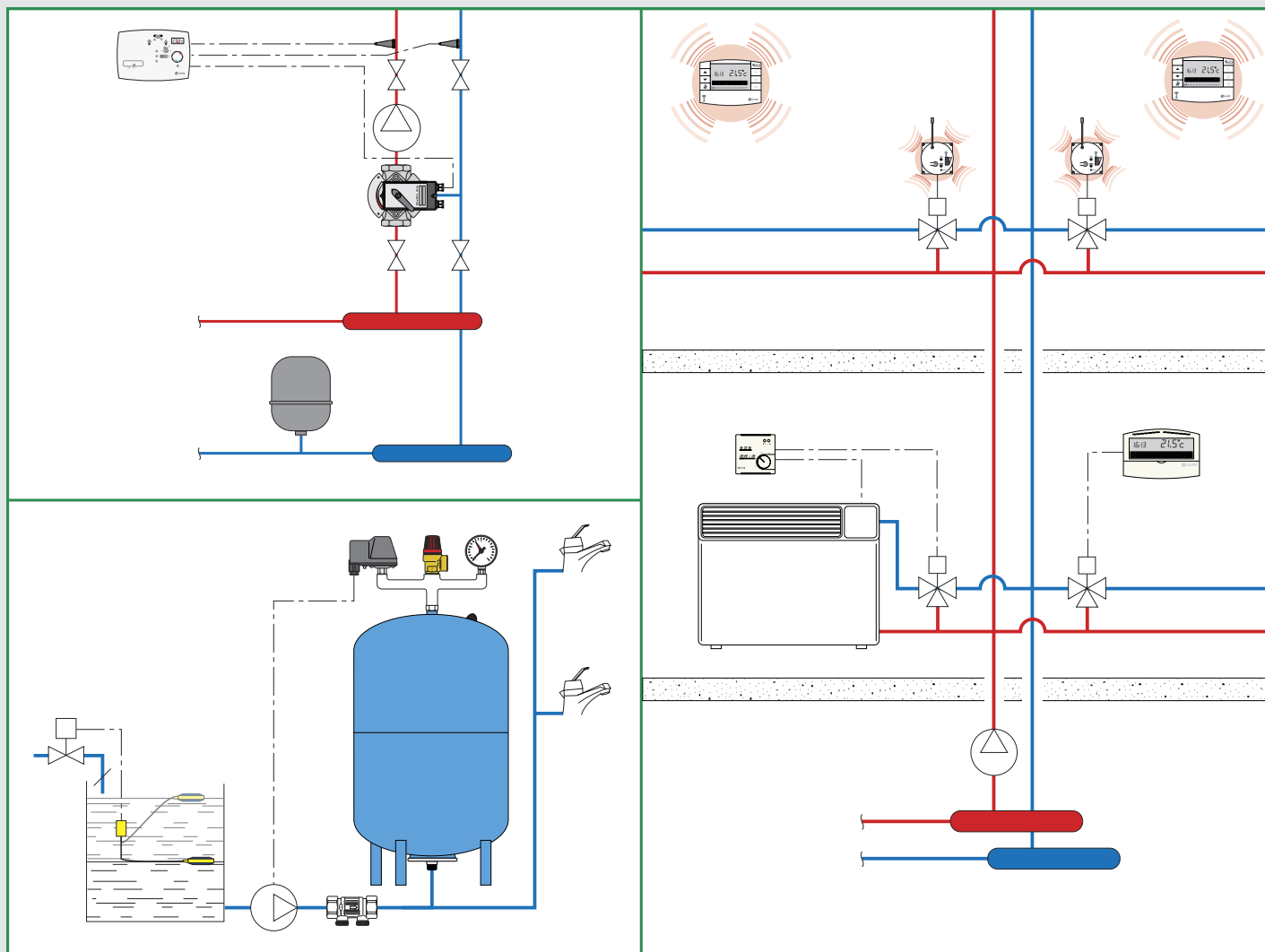

- Expansion vessels
- Shut-off cocks for expansion vessels
- Pressure switch and float switch
- Pickling gel and deoxidising powder for welding
- Mixing valves
- Actuators
- Counterflanges
- Temperature regulators
- Chrono-thermostats
- Thermostats - Hour meter - Timer
- Radio wave temperature control systems



Domestic Water Sizer 
DOMESTIC WATER SYSTEM SIZER ALSO FOR SMARTPHONE
Available on www.caleffi.com and app for smartphone.
Download the version for your iOS and Android® mobile phone.

EXPANSION VESSELS FOR HEATING SYSTEMS



556

tech. broch. 01079

Welded expansion vessel, for heating systems, EC certification. Diaphragm membrane. Max. working pressure: 6 bar. System working temperature range: -10–120°C. Membrane working temperature range: -10–70°C. Max. percentage of glycol: 50%. Conformity to EN 13831 standard.



Code	Litres	Conn.	Precharge (bar)		
556008	8	3/4"	1,5	1	–
556012	12	3/4"	1,5	1	–
556018	18	3/4"	1,5	1	–
556025	25	3/4"	1,5	1	–



556

tech. broch. 01079

Welded expansion vessel, for heating systems, EC certification. Diaphragm membrane. Max. working pressure: 6 bar. System working temperature range: -10–120°C. Membrane working temperature range: -10–70°C. Max. percentage of glycol: 50%. Conformity to EN 13831 standard.



Code	Litres	Conn.	Precharge (bar)		
556035	35	3/4"	1,5	1	–
556050	50	3/4"	1,5	1	–
556080	80	1"	1,5	1	–
556100	100	1"	1,5	1	–
556140	140	1"	1,5	1	–
556200	200	1"	1,5	1	–
556250	250	1"	1,5	1	–



556

tech. broch. 01079

Welded expansion vessel, for heating systems, EC certification. Diaphragm membrane. Max. working pressure: 6 bar. System working temperature range: -10–120°C. Membrane working temperature range: -10–70°C. Max. percentage of glycol: 50%. Conformity to EN 13831 standard.



Code	Litres	Conn.	Precharge (bar)		
556300	300	1"	1,5	1	–
556400	400	1"	1,5	1	–
556500	500	1"	1,5	1	–
556600	600	1"	1,5	1	–

EXPANSION VESSELS FOR HOT WATER SYSTEMS



5557



tech. broch. 01079

Welded expansion vessel, for hot water systems, EC certification. Bladder membrane. Max. working pressure: 10 bar. System working temperature range: -10–100°C. Membrane working temperature range: -10–100°C. Conformity to EN 13831 standard.



Code	Litres	Conn.	Precharge (bar)		
555702	2	1/2"	2,5	4	–
555705	5	3/4"	2,5	1	–
555708	8	3/4"	2,5	1	–



568



tech. broch. 01079

Welded expansion vessel, for hot water systems, EC certification. Bladder membrane. Max. working pressure: 10 bar. System working temperature range: -10–70°C. Membrane working temperature range: -10–70°C. Conformity to EN 13831 standard.



Code	Litres	Conn.	Precharge (bar)		
568008	8	3/4"	2,5	1	–
568012	12	3/4"	2,5	1	–
568018	18	3/4"	2,5	1	–
568025	25	3/4"	2,5	1	–
568033*	33	3/4"	2,5	1	–

* Complete with brackets for wall mounting



568



tech. broch. 01079

Welded expansion vessel, for hot water systems, EC certification. Bladder membrane (can be replaced for volumes from 60 to 500 litres). Max. working pressure: 10 bar. System working temperature range: -10–70°C. Membrane working temperature range: -10–70°C. Conformity to EN 13831 standard.



Code	Litres	Conn.	Precharge (bar)		
568050	50	1"	2,5	1	–
568060	60	1"	2,5	1	–
568080	80	1"	2,5	1	–
568100	100	1"	2,5	1	–
568200	200	1 1/4"	2,5	1	–
568300	300	1 1/4"	2,5	1	–
568400	400	1 1/4"	2,5	1	–
568500	500	1 1/4"	2,5	1	–

SHUT-OFF COCKS FOR EXPANSION VESSELS



558

Automatic shut-off cock, for expansion vessels.
For domestic water circuit.
 Max. working pressure: 10 bar.
 Max. working temperature: 110°C.

Code			
558500	3/4"	1	50



558

Automatic shut-off cock, for expansion vessel, with drain cock.
For domestic water circuit.
 Max. working pressure: 6 bar.
 Max. working temperature: 85°C.

Code			
558510	3/4"	1	50



5580

Ball shut-off valve, for expansion vessels, with drain cock.
For domestic water circuit.
 Max. working pressure: 6 bar.
 Max. working temperature: 85°C.

Code			
558050	3/4"	1	20
558060	1"	1	20
558070	1 1/4"	1	20

Application diagram of shut-off valve 5580 series

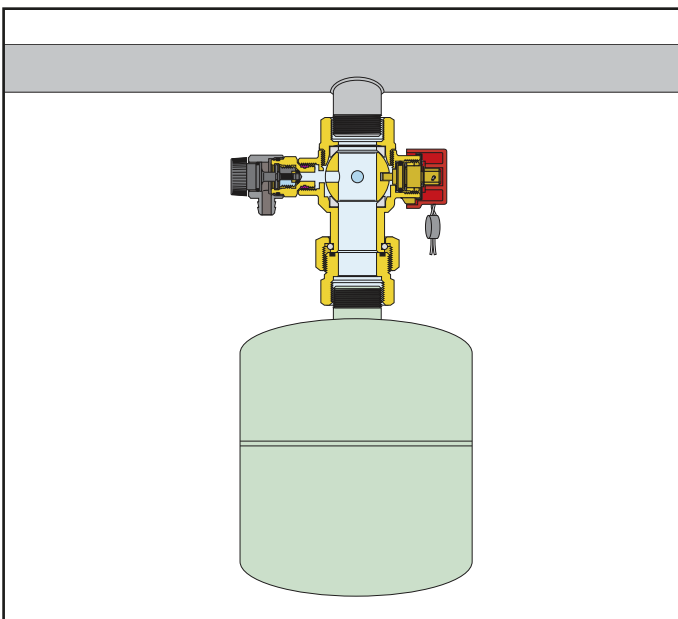

PRESSURE SWITCH AND FLOAT SWITCH



625

Pressure switch for boosting sets and domestic water applications.
 Up to 500 V three-pole - 16 (10) A.
 Ambient temperature range: 0–55°C.
 Medium temperature range: 0–55°C.
 1/4" female connection.
 Protection class: IP 44.



Code		Setting range	Max. pressure		
625005		1– 5 bar	5 bar	1	10
625010		3–12 bar	12 bar	1	10



613

Float switch, 250 V - 10 A.
 Heavy duty approved.



Code		Cable length		
613030		3 m	1	5
613050		5 m	1	5

PICKLING GEL AND DEOXIDISING POWDER FOR WELDING



6150

ECOGEL.
 Non-irritating pickling GEL to weld copper with tin.
 With brush.

Code		Quantity		
615000		110 g	60	–
615010		1 kg	1	–



6151

Pickling GEL to weld copper with tin.
 With brush.
 Quantity of GEL 100 g.

Code		Quantity		
615100		100	–	–



6152

Deoxidising powder for heavy welding of copper, bronze, brass, iron and steel.
 Quantity of POWDER 100 g.

Code		Quantity		
615200		40	–	–

MOTORIZED MIXING VALVES



6120

Motorised three-way sector mixing valve. Threaded connections. Max. working pressure: 6 bar. Temperature range: 2–110°C.

Boiler inlet on the RH connection

Code	Supply voltage V	Kv (m³/h)		
612025	3/4"	230	7,2	1 –
612026	1"	230	11,9	1 –
612027	1 1/4"	230	16,5	1 –
612028	1 1/2"	230	30	1 –
612029	2"	230	53	1 –
612021	2 1/2"	230	80	1 –



6120

Motorised three-way sector mixing valve. Threaded connections. Max. working pressure: 6 bar. Temperature range: 2–110°C.

Boiler inlet on the LH connection

Code	Supply voltage V	Kv (m³/h)		
612015	3/4"	230	7,2	1 –
612016	1"	230	11,9	1 –
612017	1 1/4"	230	16,5	1 –
612018	1 1/2"	230	30	1 –
612019	2"	230	53	1 –
612011	2 1/2"	230	80	1 –

ACTUATORS



6370

tech. broch. 01169

Actuator for mixing valves from 3/4" to 1 1/2". With auxiliary microswitch. Supply: 230 V or 24 V - 50 Hz. Power consumption: 3 VA. Auxiliary microswitch contact rating: 10 (2) A - 250 V (ac). Protection class: IP 42. Operating time: 60 s. With adapter.



Boiler inlet on the RH connection

Code	Supply voltage V	Actuator torque (N-m)		
637002	230	15	1	–
637004	24	15	1	–



6370

tech. broch. 01169

Actuator for mixing valves from 2" to 5". With double auxiliary microswitches. Supply: 230 V or 24 V - 50 Hz. Power consumption: 4,5 VA. Auxiliary microswitch contact rating: 16 (4) A - 250 V (ac). Protection class: IP 42. Operating time: 180 s. With adapter.



Code	Supply voltage V	Actuator torque (N-m)		
637012	230	35	1	–
637014	24	35	1	–



6370

Actuator for mixing valves from 3/4" to 1 1/2". With auxiliary microswitch. Supply: 230 V or 24 V - 50 Hz. Power consumption: 3 VA. Auxiliary microswitch contact rating: 10 (2) A - 250 V (ac). Protection class: IP 42. Operating time: 60 s. With adapter.



Boiler inlet on the LH connection

Code	Supply voltage V	Actuator torque (N-m)		
637001	230	15	1	–
637003	24	15	1	–

MIXING VALVES



610 [tech. broch. 01169](#)
 Three-way butterfly mixing valve.
 Threaded connections.
 Max. working pressure: 6 bar.
 Temperature range: 2–110°C.
Heavy series.
Factory setting:
boiler inlet on the RH connection.

Code		Kv (m³/h)		
610005	3/4"	7,5	1	–
610006	1"	11,9	1	–
610007	1 1/4"	16,8	1	–
610008	1 1/2"	30	1	–
610009	2"	45	1	–
610020	2 1/2"	72	1	–



610 [tech. broch. 01169](#)
 Three-way butterfly mixing valve.
 Body PN 6.
 Flanged connections.
 To be coupled with flat counterflanges EN 1092-1.
 Max. working pressure: 6 bar.
 Temperature range: 2–110°C.
Heavy series.
Factory setting:
boiler inlet on the RH connection.

Code		Kv (m³/h)		
610050	DN 50 (2")	45	1	–
610060	DN 65 (2 1/2")	72	1	–
610080	DN 80 (3")	140	1	–
610100	DN 100 (4")	183	1	–
610120	DN 125 (5")	340	1	–



611 [tech. broch. 01169](#)
 Four-way butterfly mixing valve.
 Threaded connections.
 Max. working pressure: 6 bar.
 Temperature range: 2–110°C.
Heavy series.
Factory setting:
boiler inlet on the RH connection.

Code		Kv (m³/h)		
611005	3/4"	7,8	1	–
611006	1"	12,3	1	–
611007	1 1/4"	18,5	1	–
611008	1 1/2"	30	1	–
611009	2"	53	1	–
611020	2 1/2"	80	1	–



611 [tech. broch. 01169](#)
 Four-way butterfly mixing valve.
 Body PN 6.
 Flanged connections.
 To be coupled with flat counterflanges EN 1092-1.
 Max. working pressure: 6 bar.
 Temperature range: 2–110°C.
Heavy series.
Factory setting:
boiler inlet on the RH connection.

Code		Kv (m³/h)		
611050	DN 50 (2")	53	1	–
611060	DN 65 (2 1/2")	80	1	–
611080	DN 80 (3")	140	1	–
611100	DN 100 (4")	230	1	–
611120	DN 125 (5")	410	1	–



612 [tech. broch. 01169](#)
 Three-way sector mixing valve.
 Threaded connections.
 Max. working pressure: 6 bar.
 Temperature range: 2–110°C.
Heavy series.
Factory setting:
boiler inlet on the RH connection.

Code		Kv (m³/h)		
612005	3/4"	7,2	1	–
612006	1"	11,9	1	–
612007	1 1/4"	16,5	1	–
612008	1 1/2"	30	1	–
612009	2"	42	1	–
612020	2 1/2"	62	1	–



612 [tech. broch. 01169](#)
 Three-way sector mixing valve.
 Body PN 6.
 Flanged connections.
 To be coupled with flat counterflanges EN 1092-1.
 Max. working pressure: 6 bar.
 Temperature range: 2–110°C.
Heavy series.
Factory setting:
boiler inlet on the RH connection.

Code		Kv (m³/h)		
612050	DN 50 (2")	42	1	–
612060	DN 65 (2 1/2")	62	1	–
612080	DN 80 (3")	123	1	–
612100	DN 100 (4")	172	1	–
612120	DN 125 (5")	340	1	–

MIXING VALVES

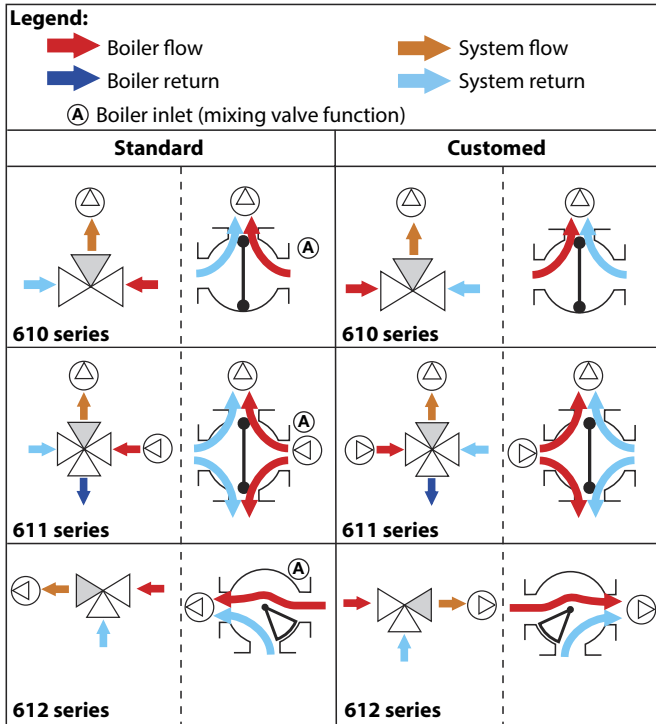

Installation example of 610 series 3-way butterfly valve with mixing valve function

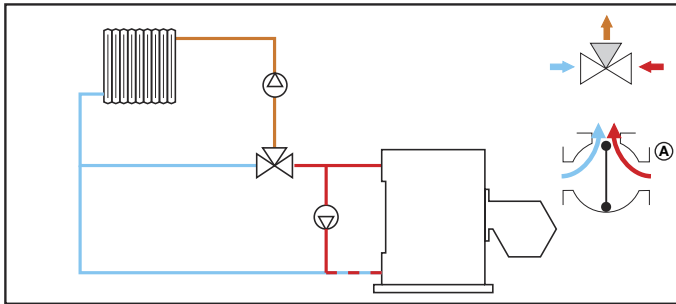

Installation example of 612 series 3-way sector valve with mixing valve function

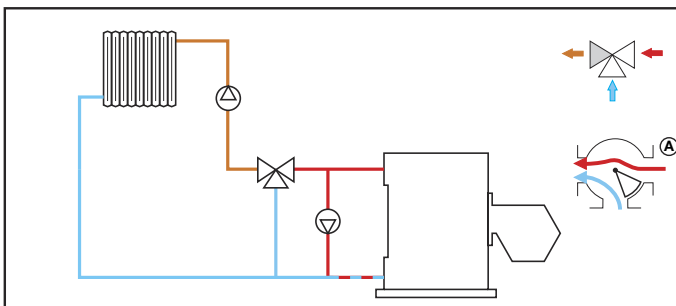

COUNTERFLANGES



616

Flat counterflange slip-on, for welding EN 1092-1, PN 6. Complete with bolts and gaskets.

Code

616030	DN 32 (1 1/4")	1	-
616040	DN 40 (1 1/2")	1	-
616050	DN 50 (2")	1	-
616060	DN 65 (2 1/2")	1	-
616080	DN 80 (3")	1	-
616100	DN 100 (4")	1	-
616120	DN 125 (5")	1	-



617

Flat counterflange slip-on, for welding EN 1092-1, PN 16. Complete with bolts and gaskets.

Code

617030	DN 32 (1 1/4")	1	-
617040	DN 40 (1 1/2")	1	-
617050	DN 50 (2")	1	-
617060	DN 65 (2 1/2") 4 holes	1	-
617080	DN 80 (3")	1	-
617100	DN 100 (4")	1	-
617120	DN 125 (5")	1	-
617150	DN 150 (6")	1	-
617200	DN 200	1	-
617250	DN 250	1	-
617300	DN 300	1	-

TEMPERATURE REGULATOR



161

Digital regulator with synoptic diagram for heating and cooling complete with immersion flow probe with pocket and Pt1000 Ø 6 mm return probe. Optional outside compensated probe. Temperature adjustment range: 5–95°C. Supply: 230 V - 50/60 Hz. Protection class: IP 20 / EN 60529. Probe cable length: 1,5 m.



Code			
161010		1	-



161

Dew point detector. Working range: 30–100 RH%.



Code			
161004		1	-



161

Remote regulator. Functions:
- translation of regulation curves,
- max. temperature,
- position OFF.



Code			
161005		1	-

Accessories for regulator code 161010.



161

Outside temperature probe.



Code			
161002		1	-

NEW



161

Centralised probe for regulator 161 series.



Code			
161003	1/2"	1	-

Code			
161020		1	-



1520

Digital temperature regulator. Complete with flow contact probe and outside probe. Adjustment range: 20–90°C. Supply: 230 V - 50/60 Hz. Protection class: IP 40.



Code			
152001	1 channel	1	-
152002	2 channels	1	-
152003	3 channels	1	-



1520

Digital temperature regulator for heating and cooling. Complete with flow probe, outside probe and max. relative humidity probe. Supply: 230 V - 50/60 Hz. Power consumption: 5,5 VA. Protection class: IP 40.



Code			
152021	1 channel	1	-

CHRONO-THERMOSTATS



618

Digital chrono-thermostat, with battery supply. Daily or weekly programmable clock. 2 temperature levels + anti-freeze. Fitted for phone programmer. 30-minute minimum programme. Output contact: 8 (2) A. Protection class: IP 30. **Class:** I-IV [Ecodesign Directive].



Code			
618101	daily	1	-
618107	weekly	1	-



738

Digital room chrono-thermostat. **4 operating programmes with ON/OFF spark advance.** Weekly programmable clock. Fitted for phone programmer. 3 temperature levels + anti-freeze. 30-minute minimum programme. ON/OFF function with adjustable differential from 0,2 to 2°C or proportional. SUMMER - WINTER switch. Adjustable temperature with 0,1°C steps. 1 changeover switch output contact: 8 (2) A. Protection class: IP 30. **Class:** I-IV [Ecodesign Directive].



Code			
738217	built-in GSM module - supply 230 V	1	-



739

Digital chrono-thermostat, with battery supply. Weekly programmable clock. Quick programming. SUMMER - WINTER switch. Output contact: 5 (2) A. Protection class: IP 30. **Class:** I-IV [Ecodesign Directive].



Code			
739107	135 x 90 x 28 mm	1	-



738

Digital room chrono-thermostat with battery electric supply. Backlit display and navigation via menu. Weekly programmable clock. Fitted for phone programmer. 3 temperature levels + anti-freeze. 30-minute minimum programme. ON/OFF function with adjustable differential from 0,2 to 2°C or proportional. SUMMER - WINTER switch. Adjustable temperature with 0,1°C steps. Relais output with changeover switch contact: 5 (3) A / 250 V. Protection class: IP 30. **Class:** I-IV [Ecodesign Directive].



Code			
738407		1	-



738

Touch screen digital chrono-thermostat with battery electric supply. Weekly programmable clock. Fitted for phone programmer. 2 temperature levels + anti-freeze. 30-minute minimum programme. ON/OFF function with adjustable differential from 0,2 to 2°C or proportional. SUMMER - WINTER switch. Adjustable temperature with 0,1°C steps. 1 changeover switch output contact: 8 (2) A. Protection class: IP 30. **Class:** I-IV [Ecodesign Directive].



Code			
738307		1	-



738

Digital room chrono-thermostat. Electric supply: 230 V. Backlit display and navigation via menu. Backlit status bar. Weekly programmable clock. Fitted for phone programmer. 3 temperature levels + anti-freeze. 30-minute minimum programme. ON/OFF function with adjustable differential from 0,2 to 2°C or proportional. SUMMER - WINTER switch. Adjustable temperature with 0,1°C steps. Relais output with changeover switch contact: 5 (3) A / 250 V. Protection class: IP 30. **Class:** I-IV [Ecodesign Directive].



Code			
738427		1	-

THERMOSTATS - HOUR METER - TIMER



620

Room thermostat with changeover switch 10 (2,5) A - 230 V - 50 Hz.
620000: without warning lamp.
620100: with warning lamp.
620110: with warning lamp ON/OFF switch.
620120: with warning lamp and SUMMER - WINTER switch.
 Protection class: IP 30.
Class: I [Ecodesign Directive].



Code		
620000	1	50
620100	1	50
620110	1	50
620120	1	50



6205

tech. broch. 01186

Control bar.
 Supply: 230 V - 50/60 Hz.
 Power consumption: max. 5,5 VA (8 outputs).
 Changeover contacts: 10 A.
 Protection class: IP 30 (with rubber cable clamps).
 Output command for pump.
 Input for SUMMER - WINTER.
 Input for timer.



Code			
620542	4 channels	1	-
620582	8 channels	1	-



619

Electronic room thermostat.
 For fan-coil.
 Supply: 230 V (ac).
 Output contact: 5 (2) A.
 Protection class: IP 30.
Class: I [Ecodesign Directive].



Code		
619120	1	10



627

5 digit hour meter,
 230 V / 24 V - 50 Hz - 1,5 W.



Code	Supply voltage V		
627002	230	1	100
627004	24	1	100



619

Electronic room thermostat.
 Daily programmable clock.
 With warning lamp and SUMMER - WINTER switch.
 Supply: 230 V (ac).
 Output contact: 8 (2) A.
 Protection class: IP 30.
Class: I [Ecodesign Directive].



Code		
619210	1	10



628

Timer with display.
 15-minute minimum ON/OFF cycle.
 Maximum number of interventions:
 96 (daily) - 672 (weekly).
 16 (2) A / 250 V. IP 40.
 230 V (ac) - 50/60 Hz.
 Diverting relay.



Code			
628001	daily	1	-
628007	weekly	1	-



620

Digital room thermostat with display.
 With changeover contact 5 (3) A.
 ON/OFF function with adjustable differential from 0,2 to 2°C or proportional.
 2 temperature levels + anti-freeze.
 SUMMER - WINTER switch.
 Adjustable temperature with 0,1°C steps.
 Protection class: IP 30.
Class: I [Ecodesign Directive].



Code			
620300	battery supply	1	10
620302	electric supply 230 V	1	10

RADIO WAVE TEMPERATURE CONTROL SYSTEMS



740 tech. broch. 01118

Digital chrono-thermostat with radio transmitter - 868 MHz. Weekly programmable clock. Fitted for phone programmer. Supply: 2 x 1,5 V alkaline penlight. ON/OFF function with adjustable differential from 0,2 to 2°C or proportional. Max. range 120 m in free air. 2 temperature levels + anti-freeze. Adjustable temperature with 0,1°C steps. Protection class: IP 30.
Class: I-IV [Ecodesign Directive].



Code		
740000	1	-



740

Table support for chrono-thermostat code 740000.

Code		
740108	1	-



740 tech. broch. 01118

Electronic room thermostat with radio transmitter - 868 MHz. Supply: 2 x 1,5 V alkaline penlight. ON/OFF function with adjustable differential from 0,2 to 2°C or proportional. Max. range 120 m in free air. SUMMER - WINTER control. Adjustable temperature with 0,1°C steps. Protection class: IP 30.
Class: I [Ecodesign Directive].



Code		
740201	1	-



740 tech. broch. 01118

Wall-mounting receiver. 1 or 2 channels - 868 MHz. Supply: 230 V - 50/60 Hz. Contact rating: 5 (2) A / 250 V. Protection class: IP 30.



Code		
740100	1 channel	1 -
740104	2 channels	1 -



740 tech. broch. 01118

Wall-mounting receiver. 8 channels - 868 MHz. Supply: 16-18 V (via control bar). Power consumption: 1 VA. 8+1 bus output for pump activation. Protection class: IP 30.



Code		
740202	1	-



740 tech. broch. 01118

Control bar. Supply: 230 V - 50/60 Hz. Power consumption: max. 5,5 VA (8 outputs + 1). Contact rating: 8 (2) A. Protection class: IP 52 (with rubber cable clamps).



Code		
740204	4 channels	1 -
740208	8 channels	1 -



741 tech. broch. 01118

Electronic actuator with radio receiver - 868 MHz. For convertible radiator or thermostatic valves. It can be combined with systems 740 series. Supply: 2 x 1,5 V alkaline penlight. Protection class: IP 30.



Code		
741000	1	-



741

Tamper-proof protection kit for actuator 741 series.

Code		
741019	1	10

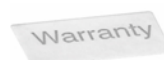

741

12 seal tamper-proof label set for actuator 741 series.

Code		
741008	1	-

HEAT SYSTEMS

This diagram is just an indication

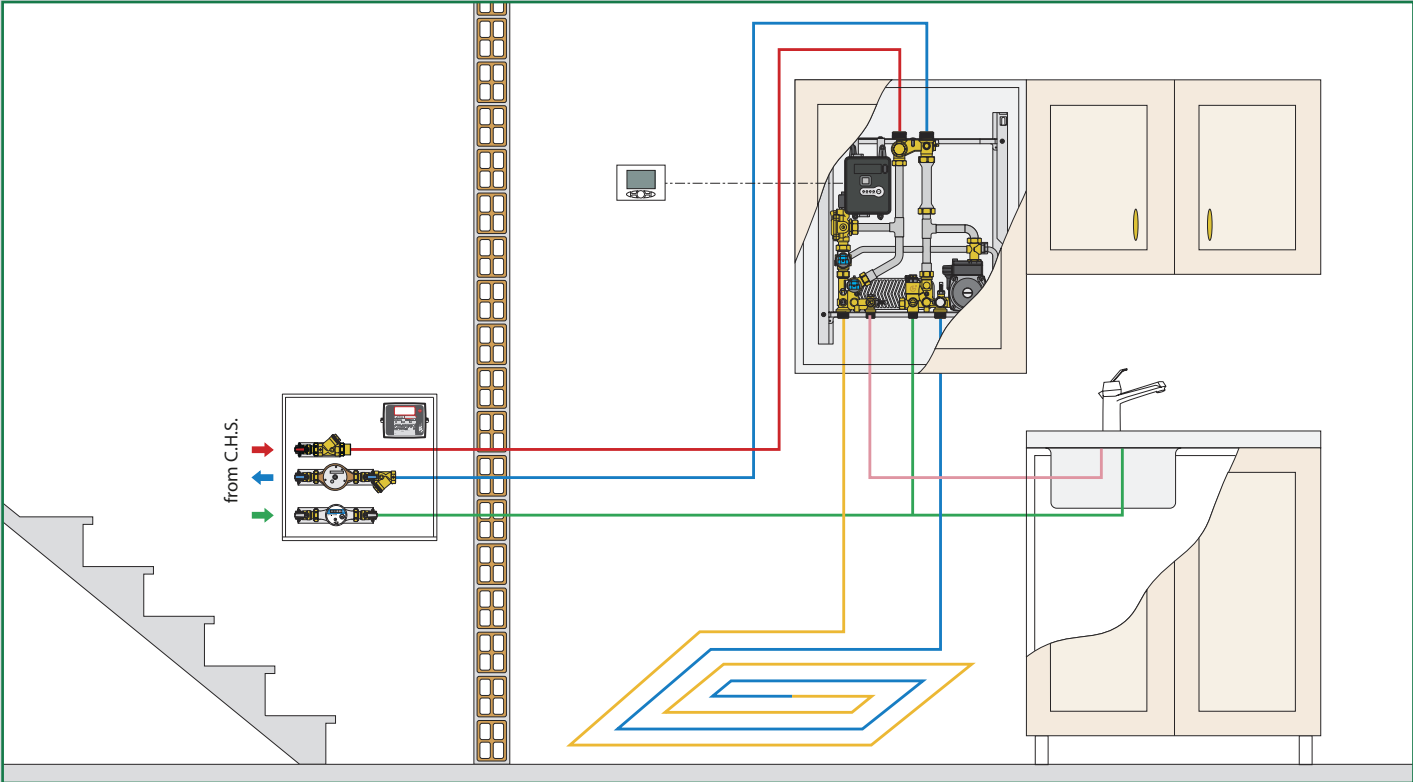
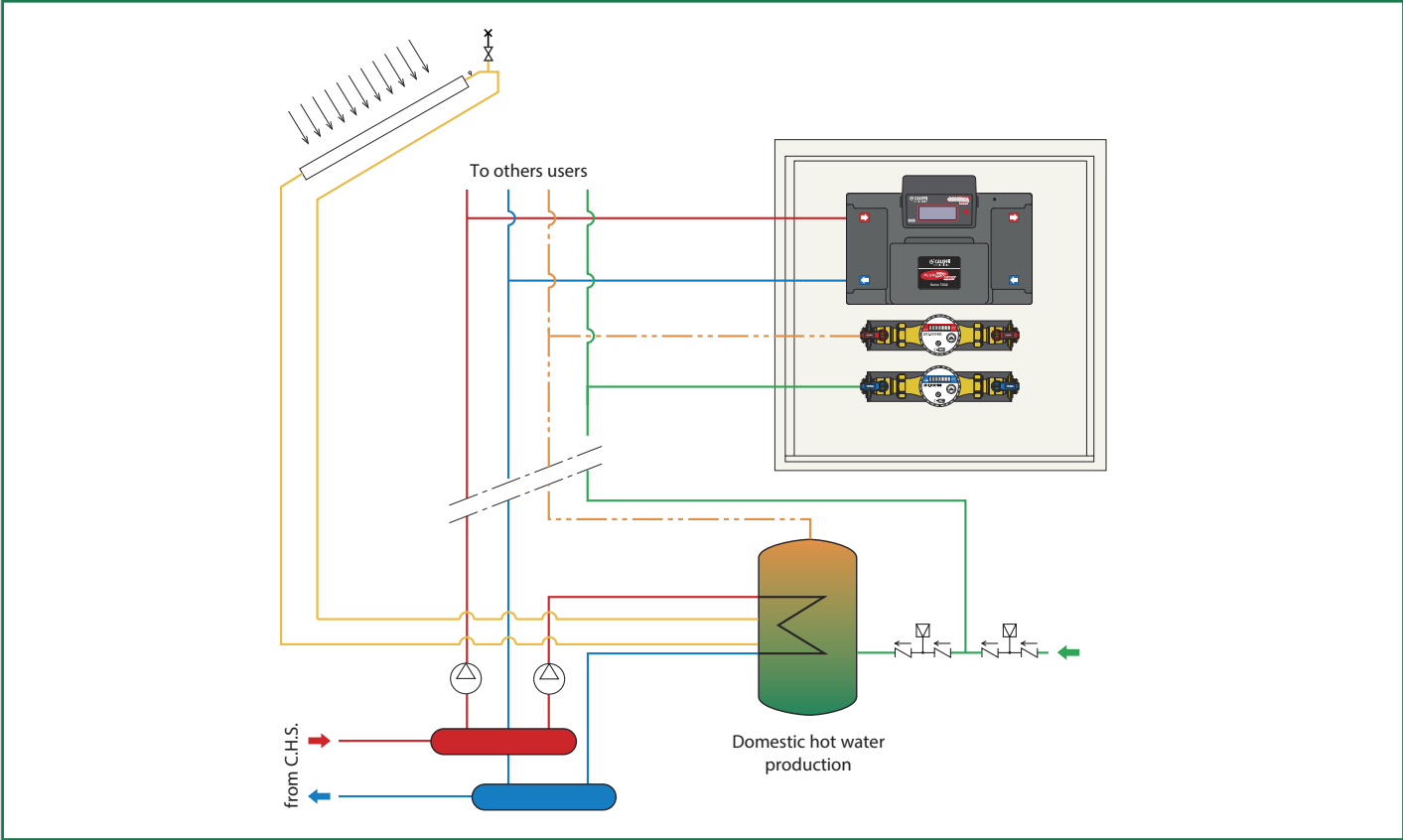

User modules
Wall mounted HIU - Instantaneous DHW production
Recess mounted HIU - Instantaneous DHW production

**PLURIMOD EASY UNIVERSAL USER MODULE
CENTRALISED DOMESTIC WATER**

700205

tech. broch. 01303

Recessed box with galvanised backplate and RAL 9010 painted door for interior use; finishing frame with adjustable depth from 130 to 160 mm.



- Complete with:
- 2 pairs of 3/4" M ball valves
 - 2 flushing pipes for initial washing of the system. Tmax 55°C
 - PPE full insulation.
- Fitted for positioning of domestic water functions codes 70005. (see page 238).

Code	Conn.	Dimension (mm)
700205	3/4"	480 x 480

**700025
DUPLEX**

tech. broch. 01113

Recessed box for double PLURIMOD EASY user. Galvanised backplate and RAL 9010 painted door for interior use; finishing frame with adjustable depth from 140 to 180 mm. Equipped with guides for positioning the brackets code 700205 002. Fitted for positioning of domestic water functions codes 70005. (see page 238).



Code	Dimension (mm)
700025	550 x 1175

700205 002

tech. broch. 01303

Module bracket for PLURIMOD EASY complete with:

- 2 pairs of 3/4" M ball valves
- 2 flushing pipes for initial washing of the system. Tmax 55°C
- PPE full insulation.

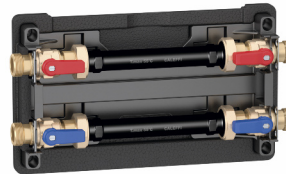

Code	Conn.
700205 002	3/4"

700205 003

tech. broch. 01303

Steel plate for fastening vertically to a wall or for inserting in a services duct.

- Complete with:
- 2 pairs of 3/4" M ball valves
 - 2 flushing pipes for initial washing of the system. Tmax 55°C
 - PPE full insulation.
- Fitted for positioning of domestic water functions codes 70005. (see page 238).

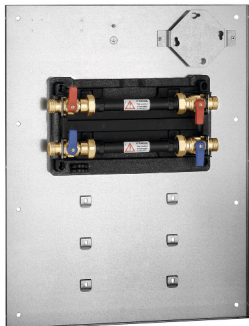

Code	Conn.	Dimension (mm)
700205 003	3/4"	480 x 610

700255 ...

tech. broch. 01303

Hydraulic module fitted for heat metering. Complete with:

- 1 zone valve unit with flow pocket with strainer mesh
- 1 template for flow meter. Tmax. 55°C
- 1 pressure independent control valve with actuator 6562 series.



Code	Actuator	Range flow rate
700255 H40	module with 230 V (ac) actuator	80-400 l/h
700255 1H2	module with 230 V (ac) actuator	120-1200 l/h

7002

tech. broch. 01303

Hydraulic module PLURIMOD EASY fitted for heat metering.

- Complete with:
- 2-way zone valve with ON/OFF control by means of thermo-electric actuator 6562 series
 - differential valve with user side control with fixed Δp
 - 2 pockets for temperature probe (flow pocket with stainless steel strainer cartridge)
 - 1 copper template for flow meter.



Code	Actuator	Δp
700217 001	module with 230 V (ac) actuator	20 kPa
700218 001	module with 24 V (ac) actuator	20 kPa
700219 001	module with 230 V (ac) actuator	30 kPa
700220 001	module with 24 V (ac) actuator	30 kPa



Copper template for flow meter to replace the plastic template.

Code
79112

PLURIMOD EASY UNIVERSAL USER MODULE CENTRALISED DOMESTIC WATER - WITH DISTRIBUTION MANIFOLD

70028

Recessed box for PLURIMOD EASY
with distribution manifold for fan-coil systems.
Galvanised backplate and RAL 9010 painted door for interior use.

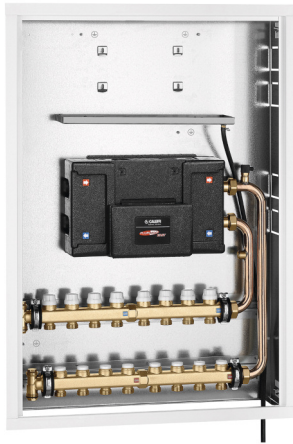

The box is supplied with:
- 2 pairs of 3/4" M ball valves
- 2 flushing pipes for initial washing of the system. Tmax 55°C
- 2 x 1" distribution manifolds **662 series** (max 8 connections).
Fitted for positioning of domestic water functions codes 70005. (see page 238).

Code	Outlets No.	Outlets	Dimension (mm)
70028B	2	3/4"	866 x 600 x 140-180
70028C	3	3/4"	866 x 600 x 140-180
70028D	4	3/4"	866 x 600 x 140-180
70028E	5	3/4"	866 x 600 x 140-180
70028F	6	3/4"	866 x 600 x 140-180
70028G	7	3/4"	866 x 600 x 140-180
70028H	8	3/4"	866 x 600 x 140-180

70029

Recessed box for PLURIMOD EASY
with distribution manifold.
Galvanised backplate and RAL 9010 painted door for interior use.



The box is supplied with:
- 2 pairs of 3/4" M ball valves
- 2 flushing pipes for initial washing of the system. Tmax 55°C
- 2 single 3/4" distribution manifolds **350 series** (max 8 connections).
Fitted for positioning of domestic water functions codes 70005. (see page 238).

Code	Outlets No.	Outlets	Dimension (mm)
70029B	2	23 p.1,5	866 x 600 x 140-180
70029C	3	23 p.1,5	866 x 600 x 140-180
70029D	4	23 p.1,5	866 x 600 x 140-180
70029E	5	23 p.1,5	866 x 600 x 140-180
70029F	6	23 p.1,5	866 x 600 x 140-180
70029G	7	23 p.1,5	866 x 600 x 140-180
70029H	8	23 p.1,5	866 x 600 x 140-180

70026

Recessed box for PLURIMOD EASY
with distribution manifold for radiant panel systems.
Galvanised backplate and RAL 9010 painted door for interior use.

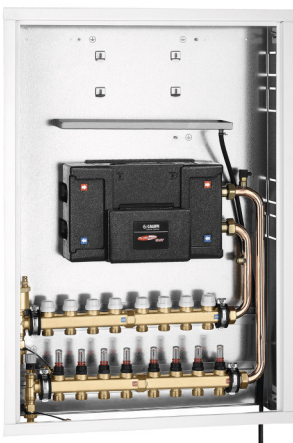

The box is supplied with:
- 2 pairs of 3/4" M ball valves
- 2 flushing pipes for initial washing of the system. Tmax. 55°C
- 2 x 1" distribution manifolds **664 series**, flow manifold **complete with flow meters and flow rate regulating valve** (max 8 connections).
Fitted for positioning of domestic water functions codes 70005. (see page 238).

Code	Outlets No.	Outlets	Dimension (mm)
70026B	2	3/4"	866 x 600 x 140-180
70026C	3	3/4"	866 x 600 x 140-180
70026D	4	3/4"	866 x 600 x 140-180
70026E	5	3/4"	866 x 600 x 140-180
70026F	6	3/4"	866 x 600 x 140-180
70026G	7	3/4"	866 x 600 x 140-180
70026H	8	3/4"	866 x 600 x 140-180

7002

tech. broch. 01303

Hydraulic module PLURIMOD EASY fitted for heat metering.
Complete with:
- 2-way zone valve with ON/OFF control by means of thermo-electric actuator 6562 series
- differential valve with user side control with fixed Δp
- 2 pockets for temperature probe (flow pocket with stainless steel strainer cartridge)
- 1 copper template for flow meter.



Code	
700217 001	module with 230 V (ac) actuator - Δp 20 kPa
700218 001	module with 24 V (ac) actuator - Δp 20 kPa
700219 001	module with 230 V (ac) actuator - Δp 30 kPa
700220 001	module with 24 V (ac) actuator - Δp 30 kPa

For HEAT METER - HYDRAULIC OPTIONS - see pages 237 - 238

**PLURIMOD UNIVERSAL USER MODULE
CENTRALISED DOMESTIC WATER**

700005

tech. broch. 01203

Recessed box with galvanised backplate and RAL 9010 painted door for interior use; finishing frame with adjustable depth from 120 to 150 mm.



Complete with:
 - 2 pairs of 3/4" M ball valves
 - 2 flushing pipes for initial washing of the system. Tmax 55°C.
 Fitted for positioning of domestic water functions codes 70005. (see page 238).

Code	Conn.	Dimension (mm)
700005	3/4"	550 x 550

**700025
DUPLEX**

tech. broch. 01113

Recessed box for double PLURIMOD user. Galvanised backplate and RAL 9010 painted door for interior use; finishing frame with adjustable depth from 140 to 180 mm. Equipped with guides for positioning the brackets code 700005 002. Fitted for positioning of domestic water functions codes 70005. (see page 238).



Code	Dimension (mm)
700025	550 x 1175

700005 003

Steel plate for fastening vertically to a wall or for inserting in a services duct. Complete with:
 - 2 pairs of 3/4" M ball valves
 - 2 flushing pipes for initial washing of the system. Tmax 55°C.
 Fitted for positioning of domestic water functions codes 70005. (see page 238).

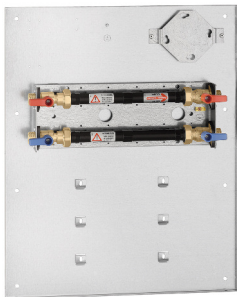

Code	Conn.	Dimension (mm)
700005 003	3/4"	480 x 610

700005 002

Galvanized sheet metal mounting bracket for PLURIMOD plumbing module. Complete with:
 - 2 pairs of 3/4" M ball valves
 - 2 flushing pipes for initial washing of the system. Tmax 55°C.

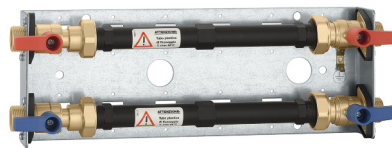

Code
700005 002

7000

tech. broch. 01203

Hydraulic module PLURIMOD fitted for heat metering.



Complete with:
 - 1 motorised zone valve
 - 2 pockets for temperature probe
 - 1 copper template for AUTOFLOW®
 - 1 copper template for flow meter
 - insulation.

Code		Max. recommended flow rate l/h
700015 001	module with 230 V (ac) actuator	1400
700016 001	module with 24 V (ac) actuator)	1400

PLURIMOD UNIVERSAL USER MODULE CENTRALISED DOMESTIC WATER - WITH DISTRIBUTION MANIFOLD

70008

tech. broch. 01203

Recessed box for PLURIMOD
with distribution manifold for fan-coil heating systems.
Galvanised backplate and RAL 9010 painted door for interior use.

The box is supplied with:
- 2 pairs of 3/4" M ball valves
- 2 flushing pipes for initial washing of the system. Tmax 55°C
- 2 x 1" distribution manifolds **662 series** (max 8 connections).
Fitted for positioning of domestic water functions codes 70005. (see page 238).

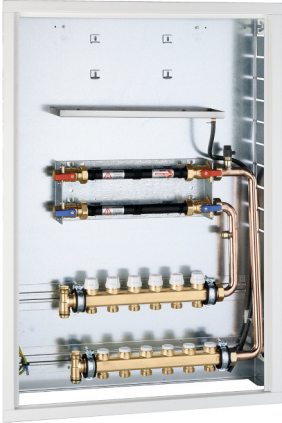

Codice	Outlets No.	Outlets	Dimension (mm)
70008B	2	3/4"	866 x 600 x 140-180
70008C	3	3/4"	866 x 600 x 140-180
70008D	4	3/4"	866 x 600 x 140-180
70008E	5	3/4"	866 x 600 x 140-180
70008F	6	3/4"	866 x 600 x 140-180
70008G	7	3/4"	866 x 600 x 140-180
70008H	8	3/4"	866 x 600 x 140-180

70009

tech. broch. 01203

Recessed box for PLURIMOD
with distribution manifold for radiator heating systems.
Galvanised backplate and RAL 9010 painted door for interior use.

The box is supplied with:
- 2 pairs of 3/4" M ball valves
- 2 flushing pipes for initial washing of the system. Tmax 55°C
- 2 single 3/4" distribution manifolds **350 series** (max 8 connections).
Fitted for positioning of domestic water functions codes 70005. (see page 238).



Codice	Outlets No.	Outlets	Dimension (mm)
70009B	2	23 p.1,5	866 x 600 x 140-180
70009C	3	23 p.1,5	866 x 600 x 140-180
70009D	4	23 p.1,5	866 x 600 x 140-180
70009E	5	23 p.1,5	866 x 600 x 140-180
70009F	6	23 p.1,5	866 x 600 x 140-180
70009G	7	23 p.1,5	866 x 600 x 140-180
70009H	8	23 p.1,5	866 x 600 x 140-180

70006

tech. broch. 01203

Recessed box for PLURIMOD
with distribution manifold for radiant panel systems.
Galvanised backplate and RAL 9010 painted door for interior use.

The box is supplied with:
- 2 pairs of 3/4" M ball valves
- 2 flushing pipes for initial washing of the system. Tmax 55°C
- 2 x 1" distribution manifolds **664 series**, flow manifold **complete with flow meters and flow rate regulating valve** (max 8 connections).
Fitted for positioning of domestic water functions codes 70005. (see page 238).



Codice	Outlets No.	Outlets	Dimension (mm)
70006B	2	3/4"	866 x 600 x 140-180
70006C	3	3/4"	866 x 600 x 140-180
70006D	4	3/4"	866 x 600 x 140-180
70006E	5	3/4"	866 x 600 x 140-180
70006F	6	3/4"	866 x 600 x 140-180
70006G	7	3/4"	866 x 600 x 140-180
70006H	8	3/4"	866 x 600 x 140-180

7000

tech. broch. 01203

Hydraulic module PLURIMOD fitted for heat metering.

Complete with:
- 1 motorised zone valve
- 2 pockets for temperature probe
- 1 copper template for AUTOFLOW®
- 1 copper template for flow meter
- insulation.



Code		Max. recommended flow rate l/h
700015 001	module with 230 V (ac) actuator	1400
700016 001	module with 24 V (ac) actuator	1400

For HEAT METER - HYDRAULIC OPTIONS - see pages 237 - 238

PLURIMOD CLIMA UNIVERSAL USER MODULE - CENTRALISED DOMESTIC WATER

700105

tech. broch. 01210

Recessed box with galvanised backplate and RAL 9010 painted door for interior use; finishing frame with adjustable depth from 120 to 150 mm.

- Complete with:
- 2 pairs of 3/4" M ball valves
 - 2 flushing pipes for initial washing of the system. Tmax 55°C
 - full insulation.
- Fitted for positioning of domestic water functions codes 70005. (see page 238).



Code	Conn.	Dimension (mm)
700105	3/4"	550 x 550

**700025
DUPLEX**

tech. broch. 01113

Recessed box for double PLURIMOD CLIMA user. Galvanised backplate and RAL 9010 painted door for interior use; finishing frame with adjustable depth from 140 to 180 mm. Equipped with guides for positioning the brackets code 700105 002. Fitted for positioning of domestic water functions codes 70005. (see page 238).



Code	Dimension (mm)
700025	550 x 1175

700105 003

Steel plate for fastening vertically to a wall or for inserting in a services duct.

- Complete with:
- 2 pairs of 3/4" M ball valves
 - 2 flushing pipes for initial washing of the system. Tmax. 55°C
 - full insulation.
- Fitted for positioning of domestic water functions codes 70005. (see page 238).

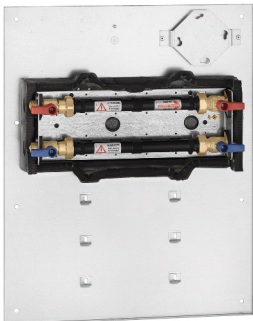

Code	Conn.	Dimension (mm)
700105 003	3/4"	480 x 610

700105 002

Galvanized sheet metal mounting bracket for PLURIMOD CLIMA plumbing module.

- Complete with:
- 2 pairs of 3/4" M ball valves
 - 2 flushing pipes for initial washing of the system. Tmax. 55°C
 - full insulation.

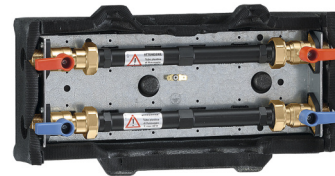

Code
700105 002

7001

Hydraulic module PLURIMOD CLIMA fitted for heat metering.

- Complete with:
- 1 zone valve unit with probe pocket
 - 1 servomotor 6450 series, IP 65
 - 1 copper template for AUTOFLOW®
 - 1 copper template for flow meter
 - by-pass adjustment knob.

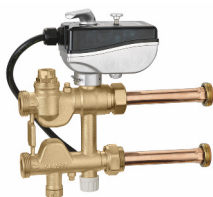

Code		Max. recommended flow rate l/h
700115 001	with actuator 230 V (ac)	1400
700116 001	with actuator 24 V (ac)	1400

For HEAT METER - HYDRAULIC OPTIONS - see pages 237 - 238

PRE-ASSEMBLED UNITS FOR PLURIMOD VAN - CENTRALISED DOMESTIC WATER

7000

Pre-assembled unit for positioning in the services duct. It can accommodate 3 complete user systems.

tech. broch. 01113

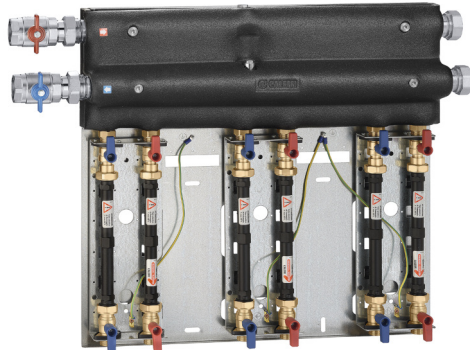

Unit with 3 outlets for heating and cooling circuits. Complete with:

- 1 dual 1 1/4" distribution manifold - 3 x 3/4" connections for heating/cooling circuit
- telescopic shut-off valves
- flushing pipes, Tmax. 55°C
- end plugs
- manifolds insulation (700036)
- full insulation (700136)

Dimension (l x h x d): 840 x 650 x 160 mm.

Code

700036	heating circuit template unit x PLURIMOD 7000 series
700136	heating and cooling circuits template unit x PLURIMOD CLIMA 7001 series

7000

Hydraulic module PLURIMOD fitted for heat metering.

tech. broch. 01203



Complete with:

- 1 motorised zone valve
- 2 pockets for temperature probe
- 1 copper template for AUTOFLOW®
- 1 copper template for flow meter
- insulation.

Code		Max. recommended flow rate l/h
700015 001	module with 230 V (ac) actuator	1400
700016 001	module with 21 V (ac) actuator	1400

7001

Hydraulic module PLURIMOD CLIMA fitted for heat metering.

Complete with:

- 1 zone valve unit with probe pocket
- 1 servomotor 6450 series, IP 65
- 1 copper template for AUTOFLOW®
- 1 copper template for flow meter
- by-pass adjustment knob.

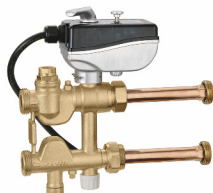

Code		Max. recommended flow rate l/h
700115 001	with 230 V (ac) actuator	1400
700116 001	with 24 V (ac) actuator	1400

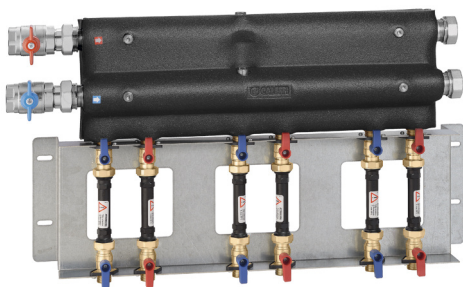

Unit with 3 outlets for domestic water circuit. Complete with:

- 1 simple 1 1/4" distribution manifold - 3 x 3/4" connections, for DHW
- 1 simple 1 1/4" distribution manifold - 3 x 3/4" connections, for DCW
- telescopic shut-off valves
- flushing pipes, Tmax. 55°C
- end plugs
- manifolds insulation.

Dimension (l x h x d): 870 x 500 x 240 mm.

Code

700037	domestic water circuit template unit
--------	--------------------------------------

For HEAT METER - HYDRAULIC OPTIONS - see pages 237 - 238

2-WAY USER MODULE - WITH AUTOFLOW® - CENTRALISED DOMESTIC WATER

799 series

tech. broch. 01103

2-way user module with AUTOFLOW®

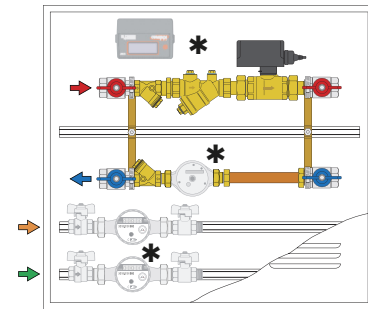
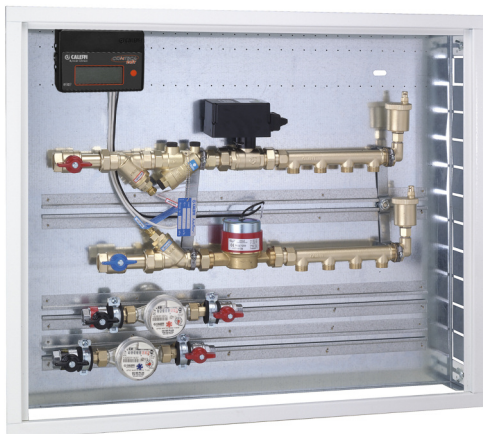

Zone outlet module complete with:

- Recessed box with galvanised backplate and RAL 9010 painted door for interior use, h = 650 mm, depth = 110 (140) mm
- pair of ball shut-off
- two-way ball zone valve 6470 series and servomotor 6460 series
- air vent 5021 series
- AUTOFLOW®
- 3/4" and 1" simple manifold 350 series, 1 1/4" manifold 650 series
- template for heat meter
- probe holder pocket (flow pocket with strainer mesh)
- connections for domestic water function 794. series.

AUTOFLOW® flow rate table

... To complete the code, please consult the table below:

7995. series
79005. series
(3/4")

with Δp range 15–200 kPa			
m³/h	... digit	m³/h	... digit
0,30	M30	0,90	M90
0,40	M40	1,00	1M0
0,50	M50	1,20	1M2
0,60	M60	1,40	1M4
0,70	M70		
0,80	M80		

7996. series
79006. series
(1")

with Δp range 15–200 kPa			
m³/h	... digit	m³/h	... digit
0,60	M60	1,40	1M4
0,70	M70	1,60	1M6
0,80	M80	1,80	1M8
0,90	M90	2,00	2M0
1,00	1M0	2,25	2M2
1,20	1M2		

7997. series
79007. series
(1 1/4")

with Δp range 15–200 kPa			
m³/h	... digit	m³/h	... digit
1,00	1M0	2,25	2M2
1,20	1M2	2,50	2M5
1,40	1M4	2,75	2M7
1,60	1M6	3,00	3M0
1,80	1M8	3,25	3M2
2,00	2M0	3,50	3M5

Code	Outlets	End conn.	Outlets conn.	Width (mm)
799560 ...	without manifolds	3/4"	-	600
79956B ...	2	3/4"	23 p.1,5	800
79956C ...	3	3/4"	23 p.1,5	800
79958D ...	4	3/4"	23 p.1,5	800
79958E ...	5	3/4"	23 p.1,5	800
79958F ...	6	3/4"	23 p.1,5	800
79958G ...	7	3/4"	23 p.1,5	1.000
79951H ...	8	3/4"	23 p.1,5	1.000
799660 ...	without manifolds	1"	-	600
79968C ...	3	1"	23 p.1,5	800
79968D ...	4	1"	23 p.1,5	800
79968E ...	5	1"	23 p.1,5	800
79961F ...	6	1"	23 p.1,5	1.000
79961G ...	7	1"	23 p.1,5	1.000
79961H ...	8	1"	23 p.1,5	1.000
79961I ...	9	1"	23 p.1,5	1.000
79962L ...	10	1"	23 p.1,5	1.200
799780 ...	without manifolds	1 1/4"	-	800
79978C ...	3	1 1/4"	3/4"	800
79978D ...	4	1 1/4"	3/4"	800
79971E ...	5	1 1/4"	3/4"	1.000
79971F ...	6	1 1/4"	3/4"	1.000
79971G ...	7	1 1/4"	3/4"	1.000
79972H ...	8	1 1/4"	3/4"	1.200
79972I ...	9	1 1/4"	3/4"	1.200
79972L ...	10	1 1/4"	3/4"	1.200

* For HEAT METER - HYDRAULIC OPTIONS - INSULATION see pages 237 - 238 - 239
The colours that identify the connection diameter are a guide to help find the corresponding heat meter, see page 237

3-WAY USER MODULE - CENTRALISED DOMESTIC WATER

796 series

tech. broch. 01101

3-way user module

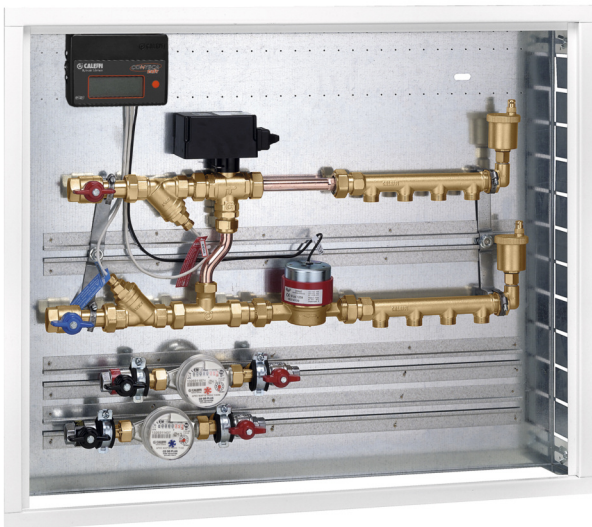
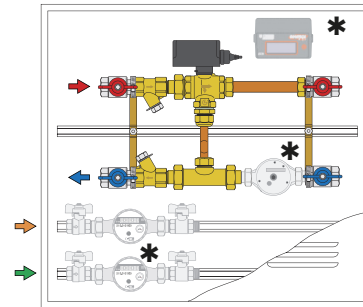

Zone outlet module complete with:

- Recessed box with galvanised backplate and RAL 9010 painted door for interior use, h = 650 mm, depth = 110 (140) mm
- pair of ball shut-off
- three-way ball zone valve 6480 series with by-pass tee 6490 series and servomotor 6460 series
- air vent 5021 series
- 3/4" and 1" simple manifold 350 series, 1 1/4" manifold 650 series
- template for heat meter
- probe holder pocket (flow pocket with strainer mesh)
- connections for domestic water function 794. series.

Code	Outlets	End conn.	Outlets conn.	Width (mm)
796560	without manifolds	3/4"	-	600
79658B	2	3/4"	23 p,1,5	800
79658C	3	3/4"	23 p,1,5	800
79658D	4	3/4"	23 p,1,5	800
79658E	5	3/4"	23 p,1,5	800
79658F	6	3/4"	23 p,1,5	800
79651G	7	3/4"	23 p,1,5	1.000
79651H	8	3/4"	23 p,1,5	1.000

796680	without manifolds	1"	-	800
79661C	3	1"	23 p,1,5	1.000
79661D	4	1"	23 p,1,5	1.000
79661E	5	1"	23 p,1,5	1.000
79661F	6	1"	23 p,1,5	1.000
79662G	7	1"	23 p,1,5	1.200
79662H	8	1"	23 p,1,5	1.200
79662I	9	1"	23 p,1,5	1.200
79662L	10	1"	23 p,1,5	1.200

796780	without manifolds	1 1/4"	-	800
79671C	3	1 1/4"	3/4"	1.000
79671D	4	1 1/4"	3/4"	1.000
79672E	5	1 1/4"	3/4"	1.200
79672F	6	1 1/4"	3/4"	1.200
79672G	7	1 1/4"	3/4"	1.200
79672H	8	1 1/4"	3/4"	1.200

Spare wall box

R79674	600 x 650 x 110/140 mm
R79675	800 x 650 x 110/140 mm
R79676	1000 x 650 x 110/140 mm
R79677	1200 x 650 x 110/140 mm
R79088	800 x 650 x 150/175 mm

* For HEAT METER - HYDRAULIC OPTIONS - INSULATION see pages 237 - 238 - 239
The colours that identify the connection diameter are a guide to help find the corresponding heat meter, see page 237

**MODULAR DOUBLE USER MODULE
MODULAR USER MODULE SUITABLE FOR 4-PIPE SYSTEMS**

7900 series

tech. broch. 01113

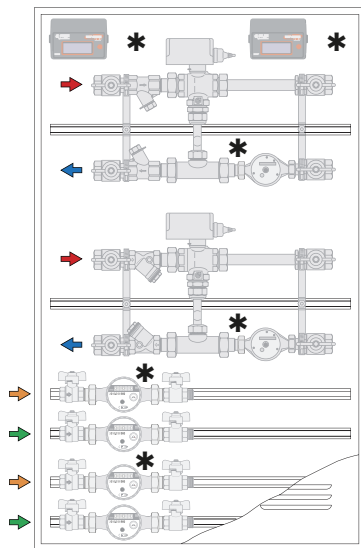
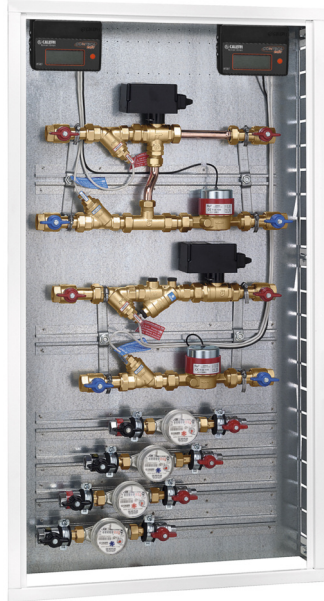

Recessed box with galvanised backplate and RAL 9010 painted door for interior use. Provided with connections for positioning two zone outlets and up to four 794. series domestic water functions.

Code	Usable dimensions (h x w x d)
790006	1100 x 600 x 110÷140
790008	1100 x 800 x 110÷140

3-way user module

Zone outlet module complete with:
 - 2 pairs of ball shut-off valves
 - 3-way ball zone valve 6480 series with by-pass tee 6490 series and actuator 6460 series
 - template for heat meter
 - probe holder pocket (flow pocket with strainer mesh).

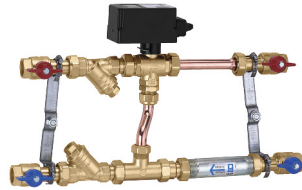

Code		Can be inserted in the following boxes:
790056	3/4" - 3-way without box	600 mm
790066	1" - 3-way without box	800 mm
790076	1 1/4" - 3-way without box	800 mm

2-way user module

Zone outlet module complete with:
 - 2 pairs of ball shut-off valves;
 - 2-way ball zone valve 6470 series and actuator 6460 series
 - connection and mounting fittings
 - template for heat meter
 - probe holder pocket (flow pocket with strainer mesh).

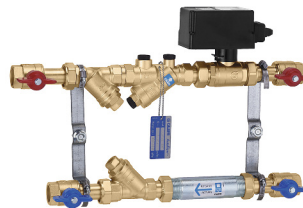

Version with AUTOFLOW® cartridge

Code		Can be inserted in the following boxes:
790059 ●●●	3/4" - 2-way without box - with AUTOFLOW®	600 mm
790069 ●●●	1" - 2-way without box - with AUTOFLOW®	600 mm
790079 ●●●	1 1/4" - 2-way without box - with AUTOFLOW®	800 mm

●●● for code completion see AUTOFLOW® cartridge table on page 228

Version without AUTOFLOW® cartridge

Code		Can be inserted in the following boxes:
790052	3/4" - 2-way without box	600 mm
790062	1" - 2-way without box	600 mm
790072	1 1/4" - 2-way without box	800 mm

*** For HEAT METER - HYDRAULIC OPTIONS - INSULATION see pages 237 - 238 - 239**
 The colours that identify the connection diameter are a guide to help find the corresponding heat meter, see page 237

DIRECT SUPPLY UNITS

765

tech. broch. 01215



Direct supply unit for heating systems.
With pre-formed insulation.
 Template for flow meter.
 Connections for direct immersion probes.
 Max. working pressure: 10 bar.
 Max. working temperature: 100°C.
 Electric supply: 230 V - 50 Hz.
 System syde conection: 1" F.
 Boiler side connection: 1 1/2" M.
 Centre distance: 125 mm.
 With UPM3 Auto L 25-70 pump.

MOTORISED REGULATING UNITS

767

tech. broch. 01215



Motorised regulating unit for heating systems.
With pre-formed insulation.
 Template for flow meter.
 Connections for direct immersion probes.
 Regulation with sector three-way valve and 3-point actuator.
 With auxiliary microswitch.
 Can be connected to digital regulators code 161010.
 Max. working pressure: 10 bar.
 Max. working temperature: 100°C.
 Electric supply: 230 V - 50 Hz.
 System side connection: 1" F.
 Boiler side connection: 1 1/2" M.
 Centre distance: 125 mm.
 With UPM3 Auto L 25-70 pump.



Reversible

Code	Conn.
765600HE	1" F



Flow on RH side when upward flow

Code	Conn.
767600HE	1" F

Flow on LH side when upward flow

Code	Conn.
767610HE	1" F

THERMOSTATIC REGULATING UNITS

766

tech. broch. 01215



Thermostatic regulating unit for heating systems.
With pre-formed insulation.
 Template for flow meter.
 Connections for direct immersion probes.
 Max. working pressure: 10 bar.
 Temperature adjustment range: 25-50°C.
 Primary inlet temperature: 100°C.
 Electric supply: 230 V - 50 Hz.
 System syde conection: 1" F.
 Boiler side connection: 1 1/2" M.
 Centre distance: 125 mm.
 With UPM3 Auto L 25-70 pump.

161

Digital regulator with synoptic diagram for heating and cooling complete with immersion flow probes with pocket and Pt1000 Ø 6 mm return probe.
 Optional outside compensated probe.
 Temperature adjustment range: 5-95°C.
 Supply: 230 V - 50/60 Hz.
 Protection class: IP 20 / EN 60529.
 Probe cable length: 1,5 m.



Code
161010



Reversible

Code	Conn.
766600HE	1" F

**COMPACT WALL MOUNTED DIRECT HEAT INTERFACE UNIT
INSTANTANEOUS DHW PRODUCTION - SATK20 SERIES**



SATK201 tech. broch. 01209

LOW temperature HIU.
Heating temperature range: 25–45°C.
Max. 18 l/min DHW.
Max. operating pressure: 10 bar.

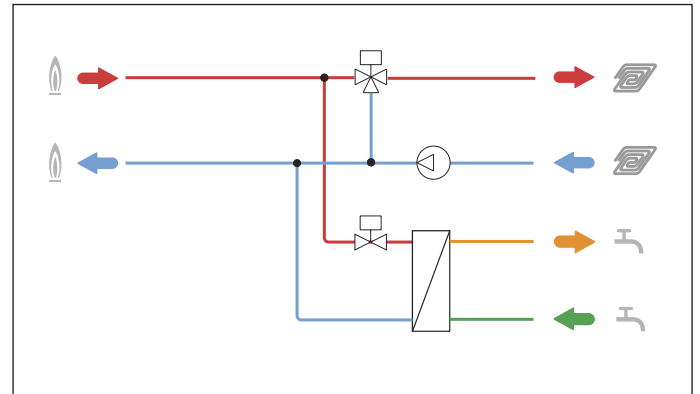

Code	Dimensions (w x h x d)
SATK20103HE heat exchanger 40 kW	450 x 550 x 265 mm



SATK202 tech. broch. 01209

MEDIUM temperature HIU.
Heating temperature range: 45–75°C.
Max. 18 l/min DHW.
Max. operating pressure: 10 bar.

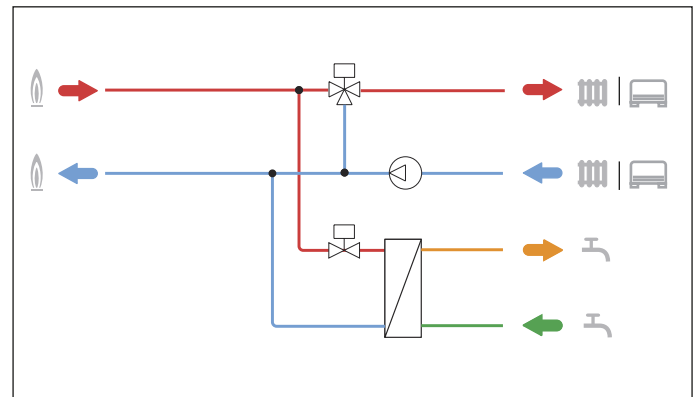

Code	Dimensions (w x h x d)
SATK20203HE heat exchanger 40 kW	450 x 550 x 265 mm



SATK203 tech. broch. 01209

HIGH temperature HIU.
Max. heating temperature: 85°C.
Max. 18 l/min DHW (SATK20303/403HE).
Max. 27 l/min DHW (SATK20305).
Max. operating pressure: 10 bar.

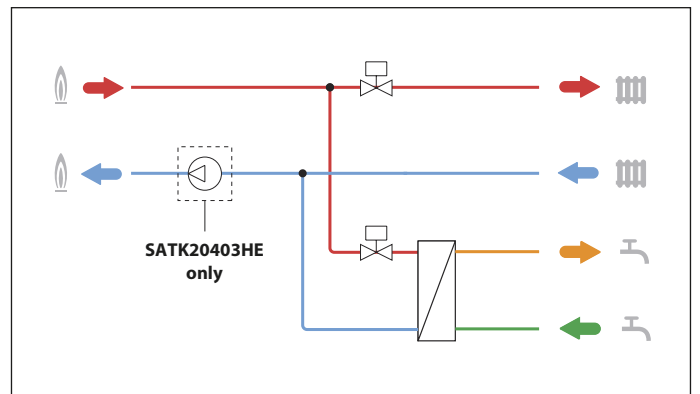

Code	Dimensions (w x h x d)
SATK20303 heat exchanger 40 kW	450 x 550 x 265 mm
SATK20305 heat exchanger 65 kW	450 x 550 x 265 mm
SATK20403HE* heat exchanger 40 kW	450 x 550 x 265 mm

*with primary pump

**COMPACT WALL MOUNTED INDIRECT HEAT INTERFACE UNIT
SATK30 - SATK40 SERIES**



SATK30 tech. broch. 01301

Heating temperature range: 25–75°C.
Max. 18 l/min DHW (SATK30103HE).
Max. 27 l/min DHW (SATK30105HE).
Max. operating pressure (primary):
16 bar.

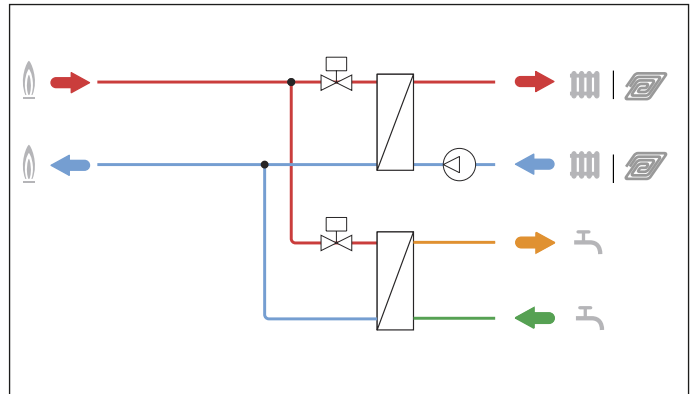

Code	Dimensions (w x h x d)
SATK30103HE heat exchanger 40 kW	550 x 630 x 265 mm
SATK30105HE heat exchanger 65 kW	550 x 630 x 265 mm



SATK40 tech. broch. 01216

Heating temperature range: 25–75°C.
DHW production in storage cylinder.
Max. operating pressure (primary):
16 bar.

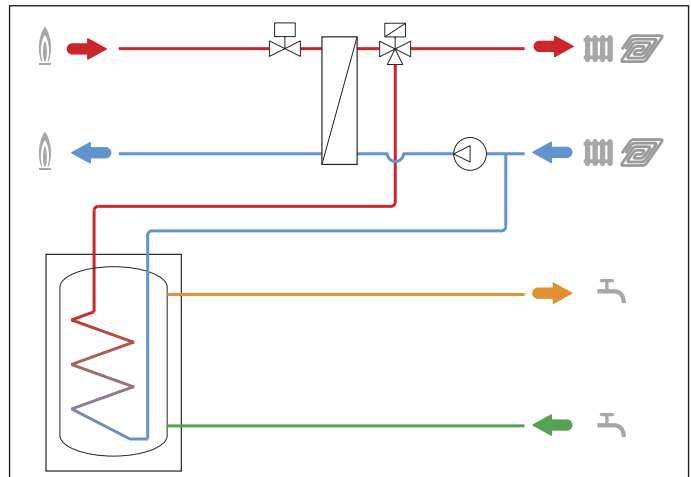

Code	Dimensions (w x h x d)
SATK40103HE	550 x 630 x 265 mm



789100
Manual flushing by-pass
for SATK20, SATK30 and SATK40.
System side connection: 3/4" M.
User side connection: 3/4" M.

Code	
789100	

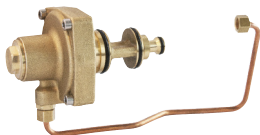

789
Differential pressure control valve.
Brass body.
Max working pressure: 16 bar.
Max. upstream Δp: 6 bar.
Fixed setting: 40 kPa.

Code	
789603	

WALL MOUNTED INDIRECT HEAT INTERFACE UNIT - SATK32 SERIES

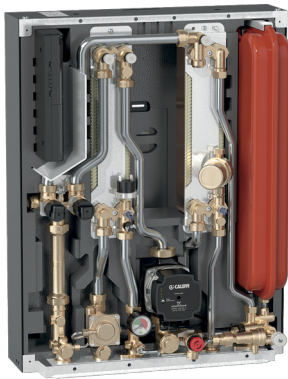

SATK32 tech. broch. 01310

Heating temperature range: 25–75°C.
 Max. 24 l/min DHW.
 Max. operating pressure (primary):
 16 bar.
With advanced electronic functions.

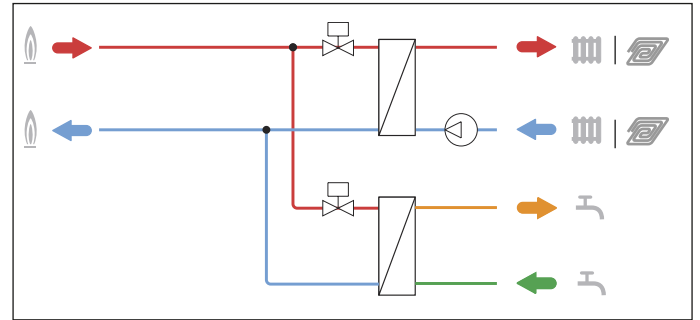

Code		Dimensions (w x h x d)
SATK32103HE	heat exchanger 50 kW	490 x 630 x 245 mm
SATK32105HE	heat exchanger 60 kW	490 x 630 x 245 mm



789110

Manual flushing by-pass
 for SATK32.
 System side connection: 3/4" F.
 User side connection: 3/4" M.

Code	
789110	



789023

Mounting template with shut-off valve
 for SATK32.

Code	
789023	



572120

Filling loop with
 CB type backflow preventer
 for SATK32.

Code	
572120	

DHW ONLY HEAT INTERFACE UNIT - SATK10 SERIES



SATK102 tech. broch. 01308

Domestic hot water production only.
 Max. operating pressure: 10 bar.

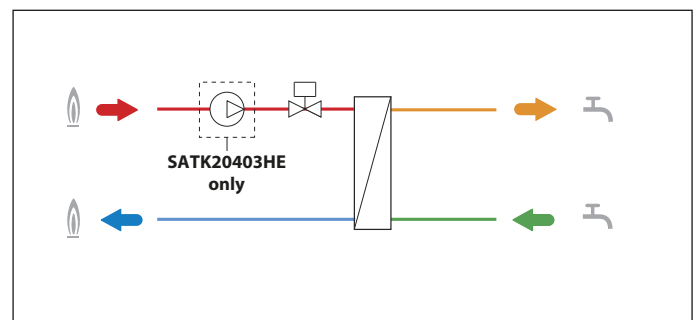

Code		Max. flow rate	Dimensions (w x h x d)
SATK10203HE	heat exchanger 40 kW	18 (l/min)	476 x 350 x 188 mm
SATK10204HE	heat exchanger 65 kW	25 (l/min)	476 x 350 x 188 mm
SATK10205HE	heat exchanger 75 kW	27 (l/min)	476 x 350 x 188 mm

Without primary pump

Code		Max. flow rate	Dimensions (w x h x d)
SATK10253	heat exchanger 40 kW	18 (l/min)	476 x 350 x 188 mm
SATK10254	heat exchanger 65 kW	25 (l/min)	476 x 350 x 188 mm
SATK10255	heat exchanger 75 kW	27 (l/min)	476 x 350 x 188 mm

**COMPACT WALL MOUNTED INDIRECT HEAT INTERFACE UNIT - MECHANICAL VERSIONS
INSTANTANEOUS DHW PRODUCTION - SATK12 - SATK15 - SATK16 SERIES**

SATK12313

Heating and DHW production.
ON/OFF primary control.
Connections: 3/4" M
1/2" M (DCW, DHW).

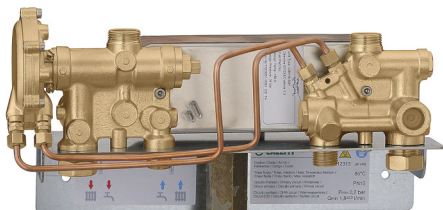

Code	Dimensions (w x h x d)
SATK12313	350 x 175 x 163 mm

SATK15313 ABC

tech. broch. 01219

Heating and DHW production.
Modulating primary control.
With DPCV on the primary side, fixed setting 30 kPa.
Connections: 3/4" M.

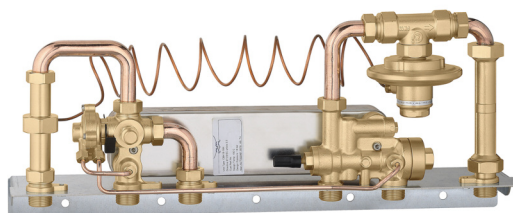

Code	Dimensions (w x h x d)
SATK15313 ABC	570 x 260 x 150 mm

SATK15303 DPCV tech. broch. 01214

Heating and DHW production.
Modulating primary control.
With DPCV on the primary side, fixed setting 30 kPa.
Connections: 3/4" M.

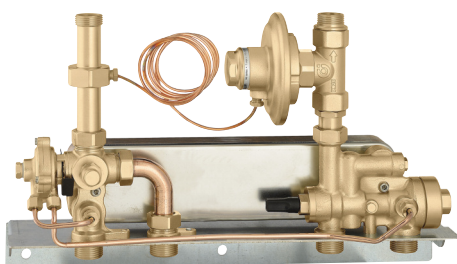

Code	Dimensions (w x h x d)
SATK15303 DPCV	420 x 250 x 130 mm

SATK16

Heating and DHW production.
Modulating primary control.
With DPCV on the primary side, fixed setting 30 kPa.
Connections: 3/4" M.
With heating zone valve and thermostatic mixing valve on DHW outlet.

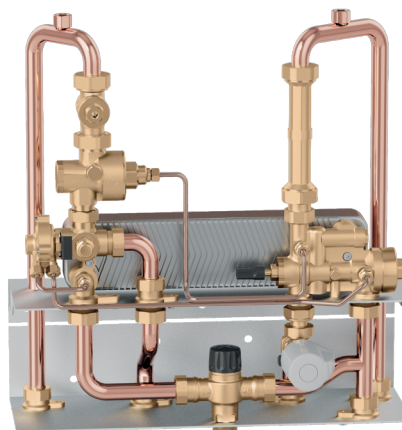

Code	Dimensions (w x h x d)
SATK16315	420 x 450 x 200 mm

**COMPACT RECESS MOUNTED DIRECT HEAT INTERFACE UNIT
INSTANTANEOUS DHW PRODUCTION - SATK50 SERIES**

SATK501

tech. broch. 01212

LOW temperature HIU.
Heating temperature range: 25–45°C.
Max. 18 l/min DHW.
Max. operating pressure: 10 bar.



Code

SATK50103HE heat exchanger 40 kW

7949

tech. broch. 01212

Recessed mounting box for SATK50, complete with shut-off valves for preliminary connections to the system.



Code

Dimensions (w x h x d)

794950 600 x 700 x 120 mm

794950 004 600 X 700 mm backplate with valves

SATK502

tech. broch. 01212

MEDIUM temperature HIU.
Heating temperature range: 45–75°C.
Max. 18 l/min DHW.
Max. operating pressure: 10 bar.



Code

SATK50203HE heat exchanger 40 kW

794540

tech. broch. 01212

Template for domestic water meter complete with:
- ball shut-off valve with non-return BALLSTOP
- flushing pipe.



Code

794540 3/4"

SATK503

tech. broch. 01212

HIGH temperature HIU.
Max. heating temperature: 85°C.
Max. 18 l/min DHW.
Max. operating pressure: 10 bar.



Code

SATK50303 heat exchanger 40 kW

DIRECT HEAT METER - CENTRALISED TRANSMISSION - BUS RS-485

CONTECA EASY 7504 series

tech. broch. 01306

Direct heat metering with local reading by means of LCD or centralised reading by means of Bus transmission.

The heat meter is supplied with:

- Pair of immersion temperature probe (L= 1,9 m).
- Turbine flow meter with pulse output (Tmax 90°C).
- Electronic integrator with LCD.
- Accuracy class: 3.
- **Electric supply 24 V (ac) 50 Hz - 1 W.**

Fitted for Bus RS-485 transmission in M-Bus protocol.
Optional MODBUS-RTU.

7504

Direct heat meter for user modules 796, 799, 7900 series. Flow meter with union connections. Pair of Y-pockets (with strainer on the flow one) included.



Code	Conn.	Meas. type	Q _p m ³ /h	Q _i l/h
750405	3/4"	single jet	2,5	50
750406	1"	multi jet	3,5	70
750407	1 1/4"	multi jet	6	120

CONTECA EASY ULTRA 7507 series

tech. broch. 01307

Direct heat metering with local reading by means of LCD or centralised reading by means of Bus transmission.

The heat meter is supplied with:

- Pair of immersion temperature probe (L= 1,9 m).
- Ultrasonic heat meter (Tmax 90°C).
- Electronic integrator with LCD.
- Accuracy class: 2.
- **Electric supply 24 V (ac) 50 Hz - 1 W**

Fitted for Bus RS-485 transmission in M-Bus protocol.
Optional MODBUS-RTU.

7507

Ultrasonic direct heat meter for user modules 796, 799, 7900 series. Flow meter with union connections. Pair of Y-pockets (with strainer on the flow one) included.

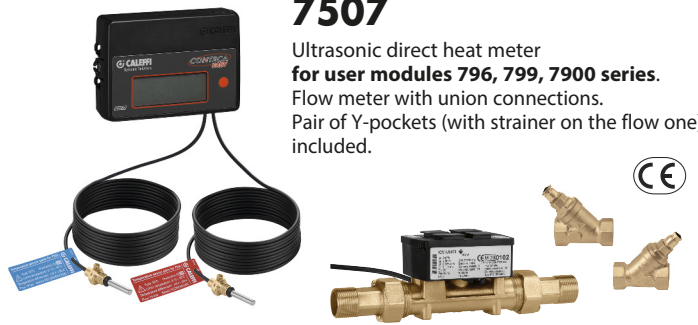

Code	Conn.	Q _p m ³ /h	Q _i l/h
750705	3/4"	2,5	10
750706	1"	3,5	35
750707	1 1/4"	6	24

7504

Direct heat meter for modules 7000, 7001, 7002 series and for distribution and regulating units 765, 766, 767 series.



Code	Conn.	Type	Q _p m ³ /h	Q _i l/h	Max. recommended flow rate l/h
750405G	3/4"	single jet	2,5	50	1600

7507

Ultrasonic direct heat meter for modules 7000, 7001, 7002 series.



Code	Conn.	Q _p m ³ /h	Q _i l/h
750705G	3/4"	2,5	10

7504

Direct heat meter for HIU SATK20, SATK30, SATK40, SATK50 series.



Code	Conn.	Type	Q _p m ³ /h	Q _i l/h	Max. recommended flow rate l/h
750405K	3/4"	single jet	2,5	50	1600

7507

Ultrasonic direct heat meter for HIU SATK20, SATK30, SATK40, SATK50 series.

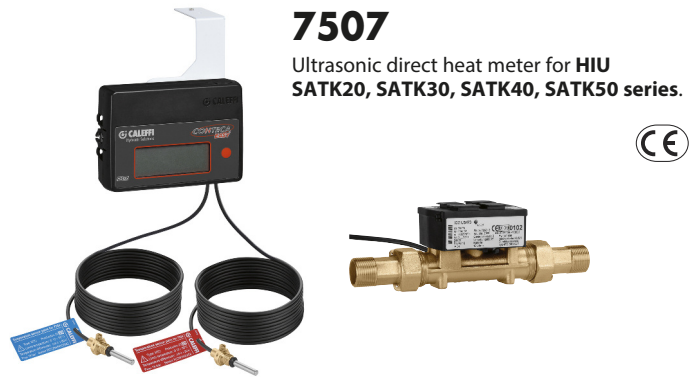

Code	Conn.	Q _p m ³ /h	Q _i l/h
750705K	3/4"	2,5	10

Q_p = permanent flow rate Q_i = minimum flow rate

Q_p = permanent flow rate Q_i = minimum flow rate

HYDRAULIC OPTIONS



70005

Domestic water meter kit.
For user module 7000, 7001, 7002
(except codes 700036 and 700136).

- Consisting of:
- ball shut-off valve with built-in check valve BALLSTOP
 - flow meter (MI001)
 - shut-off ball valve with male terminal
 - flushing pipe
 - mounting bracket.

Conforms to directive 2014/32/UE (MI001)

Code

700050	domestic hot water 3/4" with local reading
700051	domestic hot water 3/4" with pulse output
700052	domestic cold water 3/4" with local reading
700053	domestic cold water 3/4" with pulse output

700009

Template with 3/4" valves for domestic water meter.
For user module 7000, 7001, 7002
(except codes 700036 and 700136).
Tmax. 55°C.



Code

700009	
--------	--



7942

Water meter for domestic hot / cold water (MI001).
With pulse output.
1/2": for template code 794540,
3/4": for unit codes 700036 and 700136.



Conforms to directive 2014/32/UE (MI001)

Code

794204	1/2" - domestic cold water (Tmax. 30°C) - L= 110 mm
794205	3/4" - domestic cold water (Tmax. 30°C) - L= 130 mm
794205/C	3/4" - domestic hot water (30-90°C) - L= 130 mm

7941

Domestic water meter kit.
For user module 796, 799, 7900 series.

- Consisting of:
- ball shut-off valve with built-in check valve BALLSTOP
 - flow meter (MI001), with pulse output
 - shut-off ball valve with male terminal.

Conforms to directive 2014/32/UE (MI001)



Code

794140	domestic cold water 1/2"
794141	domestic hot water 1/2"
794150	domestic cold water 3/4"
794151	domestic hot water 3/4"

7940

Domestic water meter kit.
For user module 796, 799, 7900 series.

- Consisting of:
- ball shut-off valve with built-in check valve BALLSTOP
 - flow meter (MI001), with local reading
 - shut-off ball valve with male terminal.

Conforms to directive 2014/32/UE (MI001)



Code

794040	domestic cold water 1/2"
794041	domestic hot water 1/2"
794050	domestic cold water 3/4"
794051	domestic hot water 3/4"

PRE-FORMED INSULATION



798

Pre-formed insulation for user module 799, 7900 series without distribution.

Code

798205	3/4"	- 2-way module
798206	1"	- 2-way module
798207	1 1/4"	- 2-way module



789

Pre-formed insulation for SATK15 and SATK12 series. Material: expanded closed cell PE-X. Minimum thickness: 10 mm. Reaction to fire (DIN 4102): class B2.

Code

Use

789303	SATK15303 DPCV
789313	SATK15313 ABC
789312	SATK12313



798

Pre-formed insulation for user module 796, 7900 series without distribution.

Code

798305	3/4"	- 3-way module
798306	1"	- 3-way module
798307	1 1/4"	- 3-way module



798

Insulation for pair of manifolds. For user module 796, 799 series. Max. 8 outlets.

Code

798015	3/4"
798016	1"
798017	1 1/4"

N.B. : Carry out the order for the insulation together with the module. It is not possible to apply it later.

COMPONENTS FOR SOLAR THERMAL SYSTEMS

This diagram is just an indication

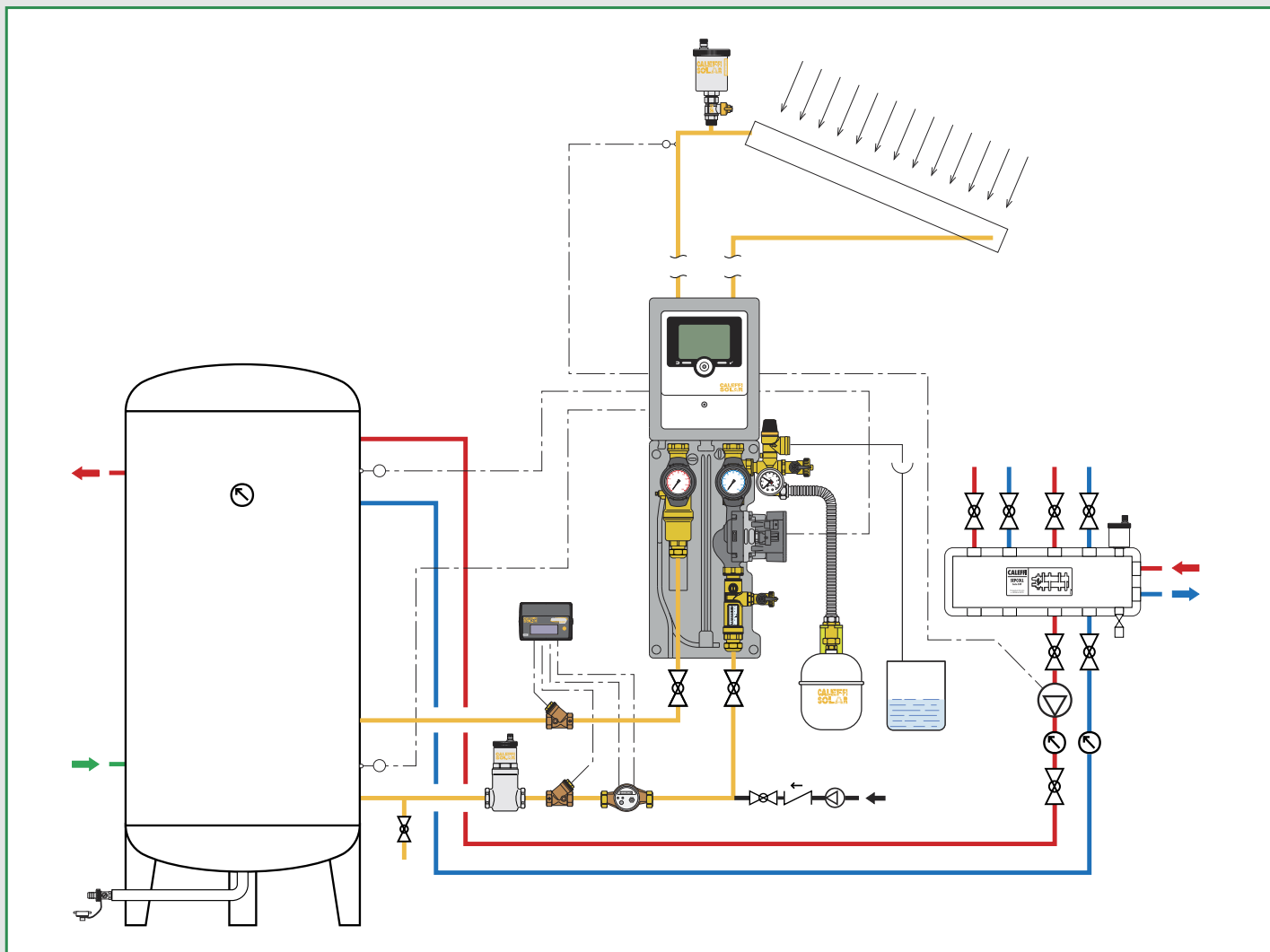

- Safety relief valve - Automatic air vents
- Deaerators, DISCAL® - Manual air separator
- Pump stations
- Ball valve - Three piece union fitting
- Mechanical fittings with O-Ring seal
- Digital regulator - Differential regulators and thermostat
- Heat meter CONTECA EASY SOLAR
- Balancing valve with flow meter
- Motorised ball diverter valve
- Thermostatic diverter valve
- Thermostatic mixing valves
- Solar storage-to-boiler connection kit
- Temperature and pressure relief valve
- Anti-freeze safety device



Domestic Water Sizer 
DOMESTIC WATER SYSTEM SIZER ALSO FOR SMARTPHONE
Available on www.caleffi.it and app for smartphone.
Download the version for your iOS and Android® mobile phone.

CALEFFI SOLAR

The CALEFFI SOLAR product range has been specifically developed for use in solar thermal systems, where high temperatures can normally be reached and where, depending on the kind of system, there can be glycol. Materials and performance of the components must necessarily take into account these particular operating conditions.

SAFETY RELIEF VALVE - AUTOMATIC AIR VENTS

253

tech. broch. 01089



Safety relief valve for solar thermal systems. Brass body. Chrome plated. Female connections. PN 10. **Temperature range: -30-160°C.** **Max. percentage of glycol: 50%.** Oversized discharge outlet. Discharge rating: 1/2" - 50 kW; 3/4" - 100 kW. TÜV certified to TRD 721 - SV 100 § 7.7. Settings: 2,5 - 3 - 4 - 6 - 8 - 10 bar.



www.tuv.com
ID 0000013604

Code

Code	Size	Pressure	Box	Pallet
253042	1/2" F x 3/4" F	2,5 bar	1	50
253043	1/2" F x 3/4" F	3 bar	1	50
253044	1/2" F x 3/4" F	4 bar	1	50
253046	1/2" F x 3/4" F	6 bar	1	50
253048	1/2" F x 3/4" F	8 bar	1	50
253040	1/2" F x 3/4" F	10 bar	1	50
253052	3/4" F x 1" F	2,5 bar	1	25
253053	3/4" F x 1" F	3 bar	1	25
253054	3/4" F x 1" F	4 bar	1	25
253056	3/4" F x 1" F	6 bar	1	25
253058	3/4" F x 1" F	8 bar	1	25
253050	3/4" F x 1" F	10 bar	1	25

250

tech. broch. 01133



Consisting of:
- Automatic air vent for solar thermal systems. Brass body. Chrome plated. Max. working pressure: 10 bar. Max. discharge pressure: 5 bar. **Temperature range: -30-180°C.** **Max. percentage of glycol: 50%.**
- Shut-off cock complete with seal. Brass body. Chrome plated. Max. working pressure: 10 bar. **Temperature range: -30-200°C.** **Max. percentage of glycol: 50%.**



Code

Code	Size	Box	Pallet
250031	3/8" M without cock	1	25
250131	3/8" M	1	25
250041	1/2" M without cock	1	25

250

Consisting of:



- Automatic air vent for solar thermal systems. Brass body. Chrome plated. Max. working pressure: 10 bar. Max. discharge pressure: 2,5 bar. **Temperature range: -30-180°C.** **Max. percentage of glycol: 50%.**
- Shut-off cock complete with seal. Brass body. Chrome plated. Max. working pressure: 10 bar. **Temperature range: -30-200°C.** **Max. percentage of glycol: 50%.**

Code

Code	Size	Box	Pallet
250831	3/8" M without cock	1	50
250931	3/8" M	1	50

251

DISCALAIR®

tech. broch. 01135



High-performance automatic air vent for solar thermal systems. Brass body. Chrome plated. Female connections. Max. working pressure: 10 bar. Max. discharge pressure: 10 bar. **Temperature range: -30-160°C.** **Max. percentage of glycol: 50%.**

Code

Code	Size	Box	Pallet
251004	1/2" F	1	10

250

tech. broch. 01133



Shut-off cock complete with seal. Brass body. Chrome plated. Max. working pressure: 10 bar. **Temperature range: -30-200°C.** **Max. percentage of glycol: 50%.**



Code

Code	Size	Box	Pallet
250300	3/8" M x 3/8" F - butterfly handle	1	10
250400	1/2" M x 1/2" F - lever handle	1	10

The automatic air vent must be shut off after the system has been filled.



DEAERATORS - MANUAL AIR SEPARATOR



251 DISCAL®

tech. broch. 01134

Deaerator for solar thermal systems.
Brass body. Chrome plated.
Female connections.
Max. working pressure: 10 bar.
Max. discharge pressure: 10 bar.
Temperature range: -30-160°C.
Max. percentage of glycol: 50%.

Code

251003 3/4" F



1 10



251 DISCAL®

tech. broch. 01134

Deaerator for solar thermal systems.
Brass body. Chrome plated.
Female connections.
With drain.
Max. working pressure: 10 bar.
Max. discharge pressure: 10 bar.
Temperature range: -30-160°C.
Max. percentage of glycol: 50%.

Code

251006 1" F



1 -

251007 1 1/4" F

1 -



251 DISCAL®

tech. broch. 01134

Deaerator for vertical pipes,
for solar thermal systems.
Brass body. Chrome plated.
Female connections.
Max. working pressure: 10 bar.
Max. discharge pressure: 10 bar.
Temperature range: -30-160°C.
Max. percentage of glycol: 50%.

Code

251905 3/4" F



1 -

251906 1" F

1 -



251

tech. broch. 01197

Manual air separator
for solar thermal systems.
Brass body.
Female connections.
Max. working pressure: 10 bar.
Temperature range: -30-200°C.
Max. percentage of glycol: 50%.

Code

251093 3/4" F



1 10

Application diagram of DISCAL® 251 series for vertical pipes

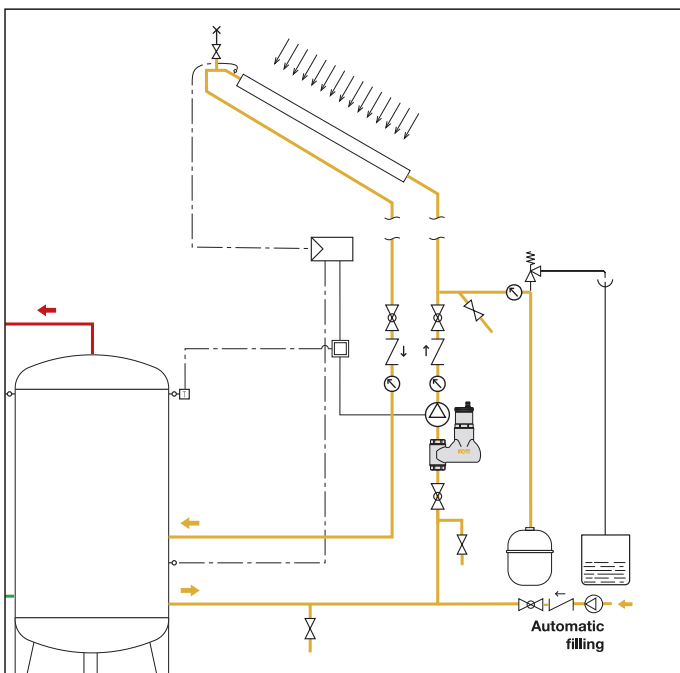

Application diagram 251 series

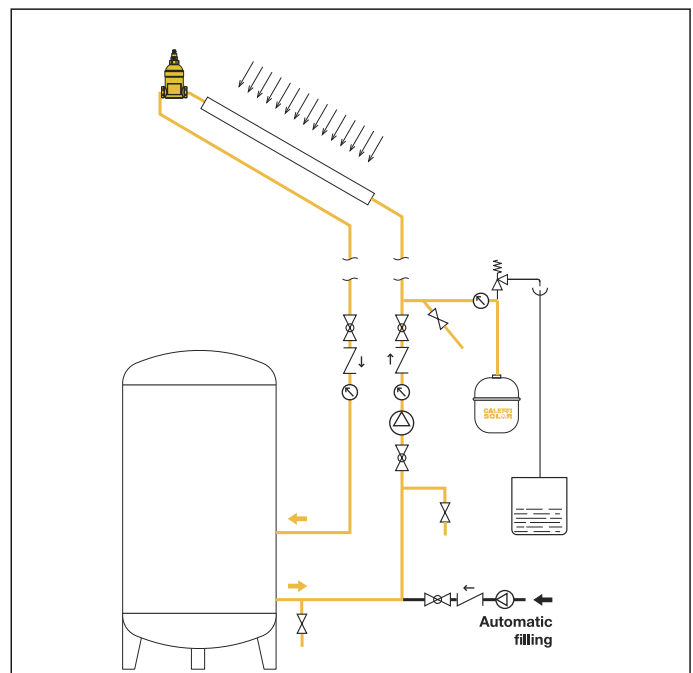

PUMP STATIONS

278

Pump station for solar thermal systems, return connection.
 Electric supply: 230 V (ac).
 Max. working pressure: 10 bar.
Safety relief valve temperature range: -30–160°C.
 Safety relief valve setting: 6 bar (for other setting, see 253 series using the adapter code F21224).
Flow meter temperature range: -10–110°C.
Max. percentage of glycol: 50%.

- Consisting of:
- Solar circulation pump;
 - safety relief valve for solar thermal systems 253 series;
 - fill/drain cock;
 - instrument holder fitting with pressure gauge;
 - flow meter;
 - return temperature gauge;
 - shut-off valve with check valve;
 - 2 hose connections;
 - pre-formed shell **insulation**.



278

Pump station for solar thermal systems, return connection.
 Electric supply: 230 V (ac).
 Max. working pressure: 10 bar.
Safety relief valve temperature range: -30–160°C.
 Safety relief valve setting: 6 bar (for other setting, see 253 series using the adapter code F21224).
Flow meter temperature range: -10–110°C.
Max. percentage of glycol: 50%.

- Consisting of:
- Solar circulation pump;
 - safety relief valve for solar thermal systems 253 series;
 - fill/drain cock;
 - instrument holder fitting with pressure gauge;
 - flow meter;
 - return temperature gauge;
 - shut-off valve with check valve;
 - 2 hose connections;
 - pre-formed shell **insulation**.

Fitted for coupling with digital regulator DeltaSol® SLL.

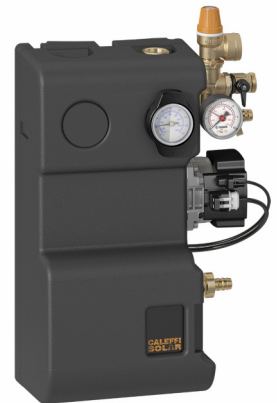

Code	Flow meter scale (l/min)	Pump		
278050HE	3/4" F 1–13	UPM3 15-75*	1	–
278052HE	3/4" F 8–30	UPM3 15-75*	1	–

* With PWM control

Code	Flow meter scale (l/min)	Pump		
278750HE	3/4" F 1–13	UPM3 15-75*	1	–
278752HE	3/4" F 8–30	UPM3 15-75*	1	–

* With PWM control

PUMP STATIONS

279

Pump station for solar thermal systems, flow and return connection.
 Electric supply: 230 V (ac).
 Max. working pressure: 10 bar.
Safety relief valve temperature range: -30–160°C.
 Safety relief valve setting: 6 bar (for other setting, see 253 series using the adapter code F21224).
Flow meter temperature range: -10–110°C.
Max. percentage of glycol: 50%.

- Consisting of:
- Solar circulation pump;
 - safety relief valve for solar thermal systems 253 series;
 - 2 fill/drain cocks;
 - instrument holder fitting with pressure gauge;
 - flow meter;
 - deaerator device;
 - flow temperature gauge;
 - return temperature gauge;
 - 2 shut-off valves with check valves;
 - 2 hose connections;
 - pre-formed shell **insulation**.

Fitted for coupling with digital regulator DeltaSol® SLL



278

Digital regulator DeltaSol® SLL with PWM control.
 Electric supply: 230 V (ac).
 Complete with pre-forme shell **insulation** for coupling with pump stations 278...HE, 279...HE and 255...HE series.
 Complete with 3 Pt1000 probes, with fourth probe as optional.
Functions: differential temperature regulator with supplementary and optional functions.
Inputs: for 4 Pt1000 probes.
Outputs: 3 semiconductor relays
 2 PWM.



Code		
278005	1	-
F29883 PWM cable	1	-

Code	Flow meter scale (l/min)	Pump		
279050HE	3/4" F 1–13	UPM3 15-75*	1	-
279052HE	3/4" F 8–30	UPM3 15-75*	1	-

* With PWM control

PUMP STATIONS

255

Pump station for solar thermal systems, flow and return connection.
 Electric supply: 230 V (ac).
 Max. working pressure: 10 bar.
Safety relief valve temperature range: -30–160°C.
 Safety relief valve setting: 6 bar (for other setting see 253 series).
Max. flow meter temperature: 120°C.
Max. percentage of glycol: 50%.

- Consisting of:
- Solar circulation pump;
 - safety relief valve for solar thermal systems 253 series;
 - 2 fill/drain cocks with hose connections;
 - instrument holder fitting with pressure gauge;
 - flow regulator with flow meter;
 - deaerator device;
 - flow temperature gauge;
 - return temperature gauge;
 - 2 shut-off valves with check valves;
 - pre-formed shell **insulation.**



Code	Flow meter scale (l/min)	Pump		
255266HE	1" F 5–40	PML 25-145*	1	–

* With PWM control

BALL VALVE

240

tech. broch. 01185



Ball valve for solar thermal systems.
Body and ball in stainless steel AISI 316.
 PN 63.
 Female connections.
 Handle in stainless steel AISI 304.
Temperature range: -30–200°C.
Max. percentage of glycol: 50%.

Code			
240400	1/2"	1	5
240500	3/4"	1	5
240600	1"	1	5

ACCESSORIES FOR PUMP STATIONS

259

tech. broch. 01246



Welded expansion vessel only for primary circuit of solar thermal systems, EC certification. Bladder membrane.
 Max. working pressure: 10 bar.
 System working temperature range: -10–120°C.
 Membrane working temperature range: -10–70°C.
 Max. percentage of glycol: 50%.
 Conformity to EN 13831 standard.

Code	Litres	Conn.	Precharge (bar)		
259008	8	3/4"	2,5	1	–
259012	12	3/4"	2,5	1	–
259018	18	3/4"	2,5	1	–
259025	25	3/4"	2,5	1	–
259033	33	3/4"	2,5	1	–

259

tech. broch. 01246



Welded expansion vessel only for primary circuit of solar thermal systems, EC certification. Diaphragm membrane.
 Max. working pressure: 10 bar.
 System working temperature range: -10–120°C.
 Membrane working temperature range: -10–70°C.
 Max. percentage of glycol: 50%.
 Conformity to EN 13831 standard.

Code	Litres	Conn.	Precharge (bar)		
259050	50	3/4"	2,5	1	–
259080	80	1"	2,5	1	–

255

tech. broch. 01136



Expansion vessel connection kit.
 Consisting of:

- stainless steel flexible hose (L=610 mm);
- automatic shut-off cock;
- wall mounting bracket (for vessels up to 24 litres).

Max. working pressure: 10 bar.
Shut-off cock max. working temperature: 110°C.
Max. percentage of glycol: 50%.

Code			
255007	3/4"	1	–

255

System filling pump for pump stations 279, 278 and 255 series.



Code		
255010	1	–



Adapter for pump stations 278 and 279 series. To be used for the installation of the 1/2" safety relief valve 253 series.

Code	
F21224	

MECHANICAL FITTINGS WITH O-RING SEAL



2540

Female fitting, mechanical O-Ring seal for solar thermal systems. For annealed copper, hard copper, brass, mild and stainless steel pipes. Max. working pressure: 16 bar. **Temperature range: -30–160°C.** **Max. percentage of glycol: 50%.** Black nickel plated nut.

Code			
254055	3/4" F - Ø 15	1	25
254058	3/4" F - Ø 18	1	25
254052	3/4" F - Ø 22	1	25
254062	1" F - Ø 22	1	25
254068	1" F - Ø 28	1	10



2546

Tee fitting, mechanical O-Ring seal for solar thermal systems. For annealed copper, hard copper, brass, mild and stainless steel pipes. Max. working pressure: 16 bar. **Temperature range: -30–160°C.** **Max. percentage of glycol: 50%.** Black nickel plated nut.

Code			
254602	Ø 22	1	20



2547

Male elbow fitting, mechanical O-Ring seal for solar thermal systems. For annealed copper, hard copper, brass, mild and stainless steel pipes. Max. working pressure: 16 bar. **Temperature range: -30–160°C.** **Max. percentage of glycol: 50%.** Black nickel plated nut.

Code			
254755	3/4" M - Ø 15	1	25
254758	3/4" M - Ø 18	1	25
254752	3/4" M - Ø 22	1	25



2543

Coupling sleeve, mechanical O-Ring seal for solar thermal systems. For annealed copper, hard copper, brass, mild and stainless steel pipes. Max. working pressure: 16 bar. **Temperature range: -30–160°C.** **Max. percentage of glycol: 50%.** Black nickel plated nut.

Code			
254305	Ø 15	1	25
254308	Ø 18	1	25
254302	Ø 22	1	25



2544

Male fitting, mechanical O-Ring seal for solar thermal systems. For annealed copper, hard copper, brass, mild and stainless steel pipes. Max. working pressure: 16 bar. **Temperature range: -30–160°C.** **Max. percentage of glycol: 50%.** Black nickel plated nut.

Code			
254455	3/4" M - Ø 15	1	25
254458	3/4" M - Ø 18	1	25
254452	3/4" M - Ø 22	1	25
254465	1" M - Ø 15	1	25
254462	1" M - Ø 22	1	25



2548

Female elbow fitting, mechanical O-Ring seal for solar thermal systems. For annealed copper, hard copper, brass, mild and stainless steel pipes. Max. working pressure: 16 bar. **Temperature range: -30–160°C.** **Max. percentage of glycol: 50%.** Black nickel plated nut.

Code			
254855	3/4" F - Ø 15	1	25
254858	3/4" F - Ø 18	1	25
254852	3/4" F - Ø 22	1	25



2540

Plug for Ø 22 copper pipe.

Code			
254002	Ø 22	1	25



2545

Elbow coupling sleeve, mechanical O-Ring seal for solar thermal systems. For annealed copper, hard copper, brass, mild and stainless steel pipes. Max. working pressure: 16 bar. **Temperature range: -30–160°C.** **Max. percentage of glycol: 50%.** Black nickel plated nut.

Code			
254505	Ø 15	1	25
254508	Ø 18	1	25
254502	Ø 22	1	25

THREE-PIECE UNION FITTING



588

Three-piece straight union fitting for solar thermal systems. Max. working pressure: 16 bar. **Temperature range: -30–160°C.** **Max. percentage of glycol: 50%.** Black nickel plated nut.

Code			
588052	3/4" F x M with union	1	25
588062	1" F x M with union	1	20

HEAT METER CONTECA EASY SOLAR

NEW

75025 CONTECA EASY SOLAR tech. broch. 01311

Direct heat metering **with local reading via LCD display/centralised reading via BUS transmission.**

Max. working pressure: 10 bar.
Temperature range: 5–120°C.
Max. percentage of glycol: 50%.

The CONTECA EASY SOLAR heat meter is supplied complete with:

- a pair of temperature probes,
- a pair of Y pockets for immersion probes,
- flow meter with pulse output (Tmax 120°C),
- electronic calculator with LCD display.

Electric supply 24 V (ac) (+10% -5%) / 50/60 Hz - 1 W.
Fitted for transmission on Bus RS-485.



Code	Conn.	Meas. type	Q _{nom} m ³ /h		
750254	1/2"	single jet	1,5	1	-
750255	3/4"	single jet	2,5	1	-
750256	1"	multi jet	3,5	1	-
750257	1 1/4"	multi jet	6	1	-
750258	1 1/2"	multi jet	10	1	-
750259	2"	multi jet	15	1	-

BALANCING VALVE WITH FLOW METER

258

tech. broch. 01148



Balancing valve with flow meter, for solar thermal systems.
Direct reading of flow rate.
Brass valve body and flow meter.
Chrome plated.
Ball valve for flow rate adjustment.
Graduated scale flow meter with magnetic movement flow rate indicator.

With insulation.

Max. working pressure: 10 bar.
Temperature range: -30–130°C.
Max. percentage of glycol: 50%.
PATENT PENDING.

Code	Flow rate range (l/min)		
258503	3/4" 2– 7	1	5
258533	3/4" 3–10	1	5
258523	3/4" 7–28	1	5
258603	1" 10–40	1	5

Application diagram of heat meter 75025 series and balancing valve 258 series

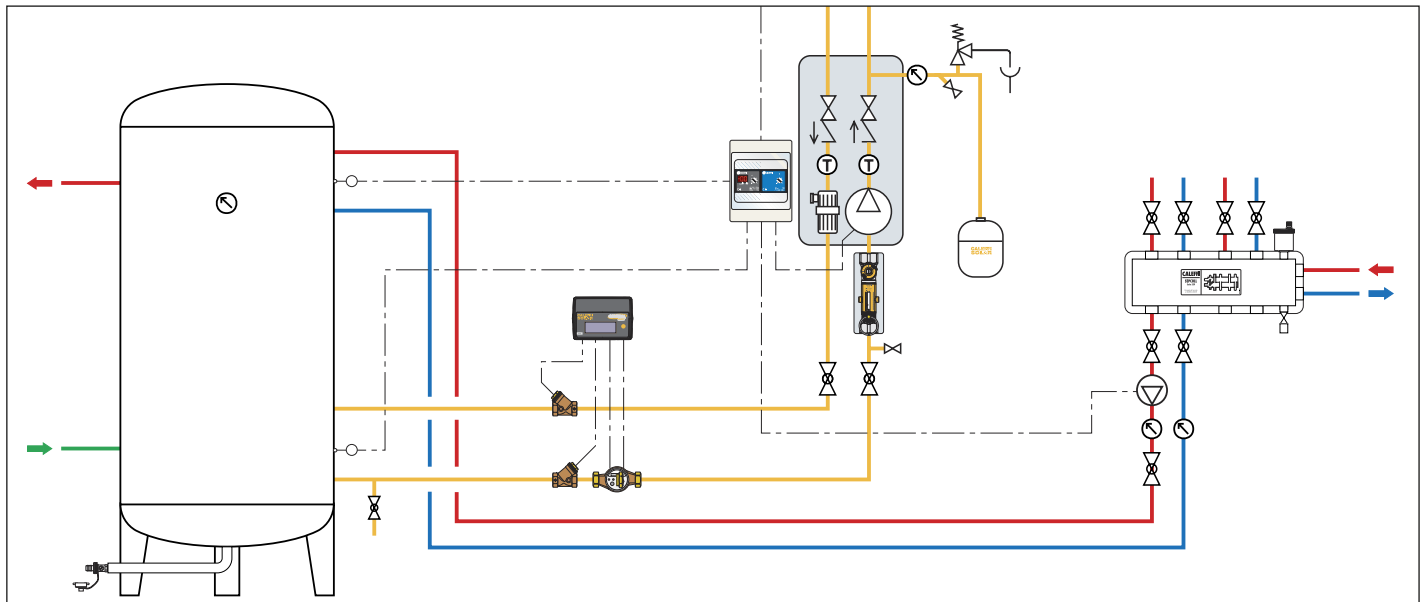

MOTORIZED BALL DIVERTER VALVE

Operating time 10 s



6443

tech. broch. 01132

Motorised three-way ball diverter valve.
Max. working pressure: 10 bar.
Max. Δp: 10 bar.
Temperature range: -5–110°C.

Complete with actuator with 3-contact control. With auxiliary microswitch.

Supply: 230 V (ac) or 24 V (ac).
Power consumption: 8 VA.

Auxiliary microswitch contact rating: 0,8 A (230 V).

Ambient temperature range: 0–55°C.
Protection class: IP 44 (vertical stem).
IP 40 (horizontal stem).

Operating time: 10 s (90° rotation).
Cable length: 100 cm.



Code	Supply voltage V	Kv (m ³ /h)		
644346	1/2"	230	3,9	1 5
644356	3/4"	230	3,9	1 5
644357	3/4"	230	8,6	1 5
644366	1"	230	9	1 5
644348	1/2"	24	3,9	1 5
644358	3/4"	24	3,9	1 5
644359	3/4"	24	8,6	1 5
644368	1"	24	9	1 5

THERMOSTATIC DIVERTER VALVE

2620

tech. broch. 01335

Thermostatic diverter valve for solar thermal systems.
CR dezincification resistant alloy body. Chrome plated.
Max. working pressure: 10 bar.
Factory setting: 45°C.
Max. inlet temperature: 100°C.



Code	Temperature adjustment	Kv (m ³ /h)		
262040	1/2"	35–55°C	1,5	1 10
262050	3/4"	35–55°C	1,7	1 10

NEW

2620

Thermostatic diverter valve for solar thermal systems.
CR dezincification resistant alloy body. Chrome plated.
Max. working pressure: 10 bar.
Factory setting: 45°C.
Max. inlet temperature: 100°C.



Code	Temperature adjustment	Kv (m ³ /h)		
262055	3/4"	38–52°C	2,6	1 5
262060	1"	38–52°C	2,6	1 10

Application diagram of 2620 series thermostatic diverter valve

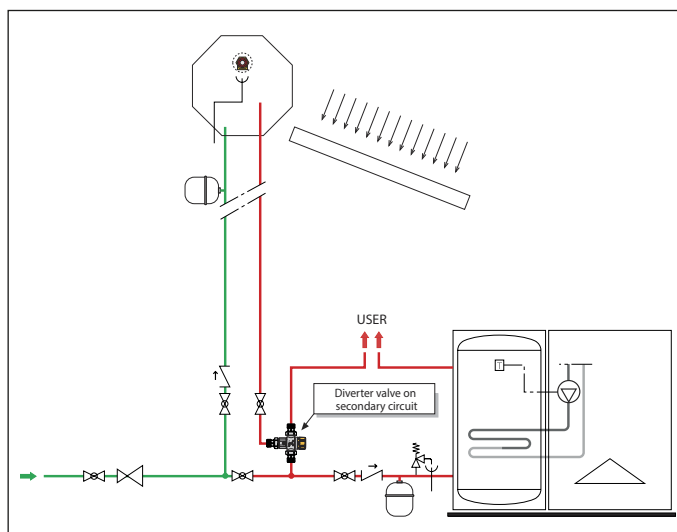



THERMOSTATIC MIXING VALVES



2521  [tech. broch. 01127](#)
 Adjustable thermostatic mixing valve for solar thermal systems.
 CR dezincification resistant alloy body.
 Chrome plated.
 Male union connections.
 Max. working pressure: 14 bar.
Max. inlet temperature: 100°C.



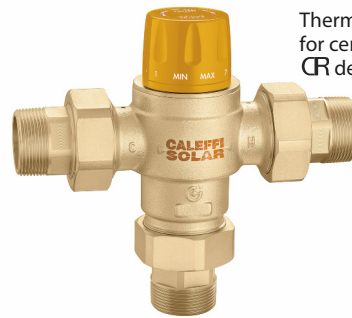

Code	Temperature adjustment	Kv (m³/h)		
252140	1/2"	30-65°C	2,6	1 10
252150	3/4"	30-65°C	2,6	1 10



2521  [tech. broch. 01257](#)
 Thermostatic mixing valve for centralised solar thermal systems.
 CR dezincification resistant alloy body.
 Male union connections.
 Antiscale inner regulator in technopolymer.
 Max. working pressure: 14 bar.
Max. inlet temperature: 100°C.





Code	Temperature adjustment	Kv (m³/h)		
252151	3/4"	35-65°C	4,5	1 10
252160	1"	35-65°C	5,5	1 -
252170	1 1/4"	35-65°C	7,6	1 -
252180	1 1/2"	35-65°C	11,0	1 -
252190	2"	35-65°C	13,3	1 -



2521  [tech. broch. 01127](#)
 Adjustable thermostatic mixing valve, **with check valves**, for solar thermal systems.
 CR dezincification resistant alloy body.
 Chrome plated.
 Male union connections.
 Max. working pressure: 14 bar.
Max. inlet temperature: 100°C.



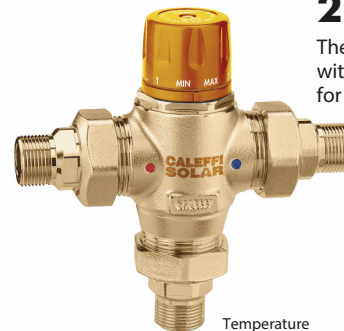

Code	Temperature adjustment	Kv (m³/h)		
252153	3/4"	30-65°C	2,6	1 10



2523  [tech. broch. 01129](#)
 Thermostatic mixing valve with interchangeable cartridge for solar thermal systems.
 Brass body.
 Male union connections.
 Max. working pressure: 14 bar.
Max. inlet temperature: 110°C.



Code	Temperature adjustment	Kv (m³/h)		
252340	1/2"	30-65°C	4,0	1 10
252350	3/4"	30-65°C	4,5	1 10
252360	1"	30-65°C	6,9	1 -
252370	1 1/4"	30-65°C	9,1	1 -
252380	1 1/2"	35-65°C	14,5	1 -
252390	2"	35-65°C	19,0	1 -

Application diagram of thermostatic mixing valve 2521 series

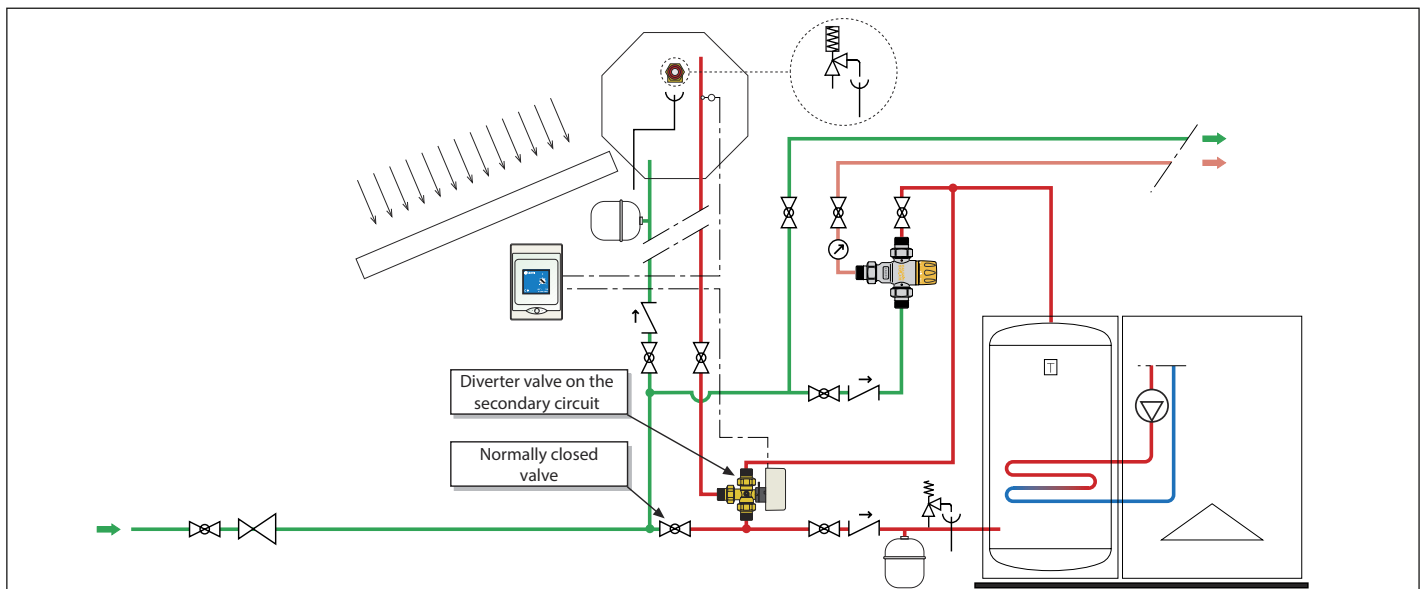

ANTI-SCALD THERMOSTATIC AND TEMPERING MIXING VALVES

2527



Adjustable anti-scald thermostatic mixing valve, **with check valves and strainers**, for solar thermal systems. High thermal performance device **with anti-scald safety function**.
 CR dezincification resistant alloy body.
 Chrome plated.
 Male union connections.
 Performance to standards NF 079 doc. 8, EN 15092, EN 1111, EN 1287.
 Max. working pressure: 10 bar.
Max. inlet temperature: 100°C.



Code	Temperature adjustment	Kv (m ³ /h)		
252714	1/2"	35–55°C	1,5	1 10
252713	3/4"	35–55°C	1,7	1 10

2522



Adjustable thermostatic mixing valve **with check valves and strainers**, for solar thermal systems. Enhanced thermal performance device **with anti-scald safety function**.
With override function for thermal disinfection.
 CR dezincification resistant alloy body.
 Chrome plated.
 Male union connections.
 Max. working pressure: 1400 kPa.
Max. inlet temperature: 100°C.
Certified to AS 4032.1.



Code	Temperature adjustment	Kv (m ³ /h)		
252212TMF AUS*	DN 15	30–50°C	1,5	1 10
252219TMF AUS	DN 20	30–50°C	1,7	1 6

* Without union

2522



High performance adjustable anti-scald tempering valve **with check valves and strainers** at the inlets. Suitable for solar and instantaneous hot water systems.
 CR dezincification resistant alloy body.
 Chrome plated.
 Male union connections.
 Max. working pressure: 1400 kPa.
Max. inlet temperature: 100°C.
Certified to AS 4032.2.



Code	Temperature adjustment	Kv (m ³ /h)		
252212HP AUS	DN 15	35–55°C	1,5	1 10
252219HP AUS	DN 20	35–55°C	1,7	1 5

2522



Adjustable thermostatic mixing valve **with check valves and strainers**, for solar thermal systems. Enhanced thermal performance device **with anti-scald safety function**.
 CR dezincification resistant alloy body.
 Chrome plated.
 Male union connections.
 Max. working pressure: 1400 kPa.
Max. inlet temperature: 100°C.
Certified to AS 4032.1.



Code	Temperature adjustment	Kv (m ³ /h)		
252212TM AUS	DN 15	30–50°C	1,5	1 10
252219TM AUS	DN 20	30–50°C	1,7	1 10
252225TM AUS	DN 25	30–50°C	3,0	1 5

SOLAR STORAGE-TO-BOILER CONNECTION KIT

264 SOLARNOCAL

tech. broch. 01163

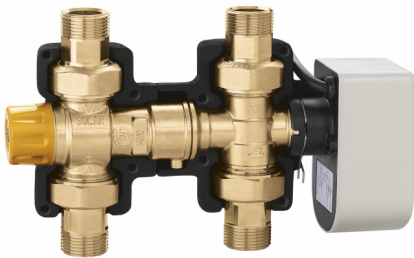

Function

A thermostatic anti-scald mixing valve, at the kit inlet, controls the temperature of the water coming from the solar hot water storage. The thermostat, by means of the probe positioned on the hot water flow from the solar hot water storage, controls the diverter valve at the kit outlet. Depending on the temperature setting, the valve diverts the water towards the user circuit or activates the boiler circuit, **without thermal integration**.

Hydraulic diagrams

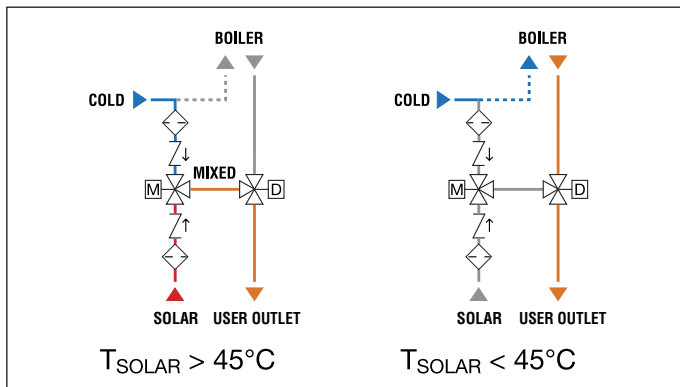

Solar storage-to-boiler connection kit, **without thermal integration**. Consisting of:

- thermostatic anti-scald mixing valve, adjustable with knob, for solar thermal systems. Complete with strainers and check valves at the inlets;
- diverter valve with three-contact actuator, with auxiliary microswitch;
- thermostat with probe for solar thermal system, for operating diverter valve. Display showing temperature.
- pre-formed **shell protective cover**.

Diverter-to-mixing valve coupling with adjustable position of the inlet and outlet connections.

Mixing valve

CR dezincification resistant alloy body.
Max. working pressure: 10 bar.
Adjustment temperature range: 35–55°C.
Max. inlet temperature: 100°C.

Diverter valve

Brass body.
Max. working pressure: 10 bar.
Temperature range: -5–110°C.

Actuator

Three-contact type.
Supply: 230 V (ac).
Power consumption: 8 VA.
Auxiliary microswitch contact rating: 0,8 A (230 V).
Ambient temperature range: 0–55°C.
Protection class: IP 44 (vertical stem).
IP 40 (horizontal stem).

Operating time: 10 s.
Cable length: 1 m.

Thermostat with probe

Supply: 230 V (ac).
Adjustable temperature range: 25–50°C.
Factory setting: 45°C.
Box protection class: IP 54.

Code			
264352	3/4"	1	-

Spare parts for connection kit 264 and 265 series.

Code	
F29399	actuator
F29488	Ø 6 mm probe
257004	stainless steel pocket for Pt1000 probe

Application diagram of SOLARNOCAL kit 264 series

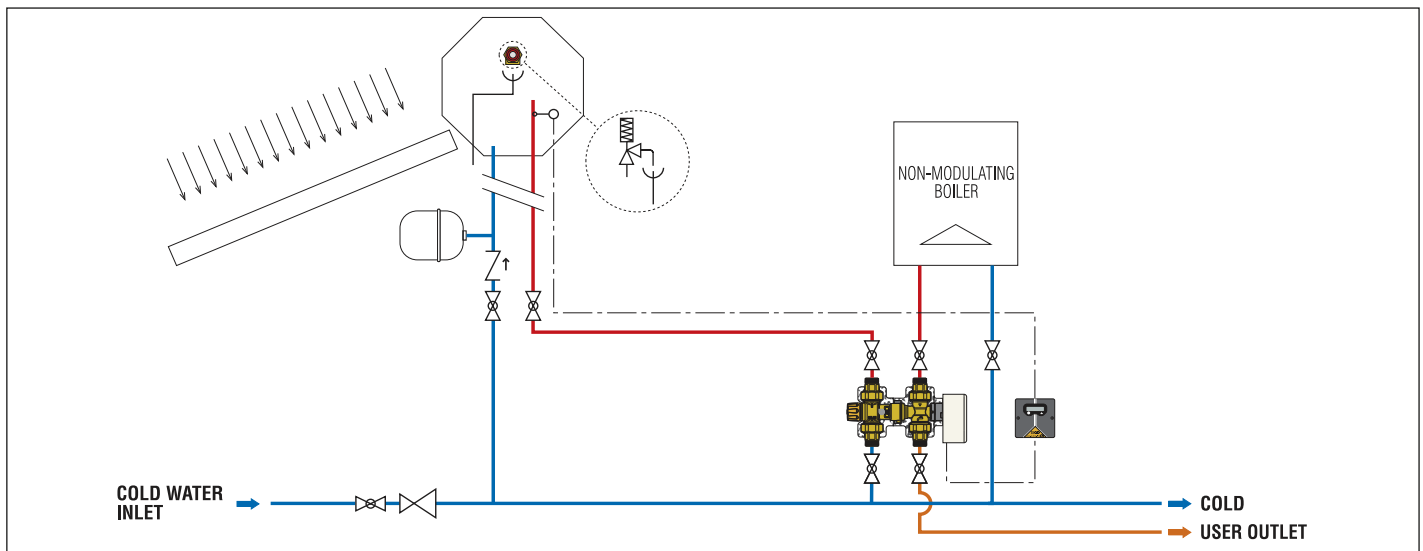

SOLAR STORAGE-TO-BOILER CONNECTION KIT

265 SOLARINCAL

tech. broch. 01163



Function

The thermostat, by means of the probe positioned on the hot water flow from the solar hot water storage, controls the diverter valve at the kit inlet. Depending on the temperature setting, the valve diverts the water towards the user circuit or the boiler circuit, **with thermal integration**. A thermostatic anti-scald mixing valve, at the kit outlet, constantly controls the temperature of the water sent to the user.

Solar storage-to-boiler connection kit, **with thermal integration**. Consisting of:

- thermostatic anti-scald mixing valve, adjustable with knob, for solar thermal systems. Complete with strainers and check valves at the inlets;
- diverter valve with three-contact actuator, with auxiliary microswitch;
- thermostat with probe for solar thermal system, for operating diverter valve. Display showing temperature.
- pre-formed **shell protective cover**.

Diverter-to-mixing valve coupling with adjustable position of the inlet and outlet connections.

Mixing valve
For technical details see 264 series.

Diverter valve
For technical details see 264 series.

Actuator
For technical details see 264 series.

Thermostat with probe
For technical details see 264 series.

Code			
265352	3/4"	1	-
F29384	mixing valve spare for 262 and 265 series	1	-

Hydraulic diagrams

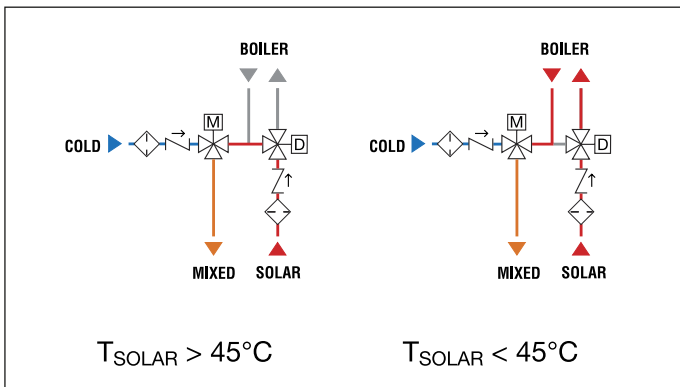

Application diagram of SOLARINCAL kit 265 series

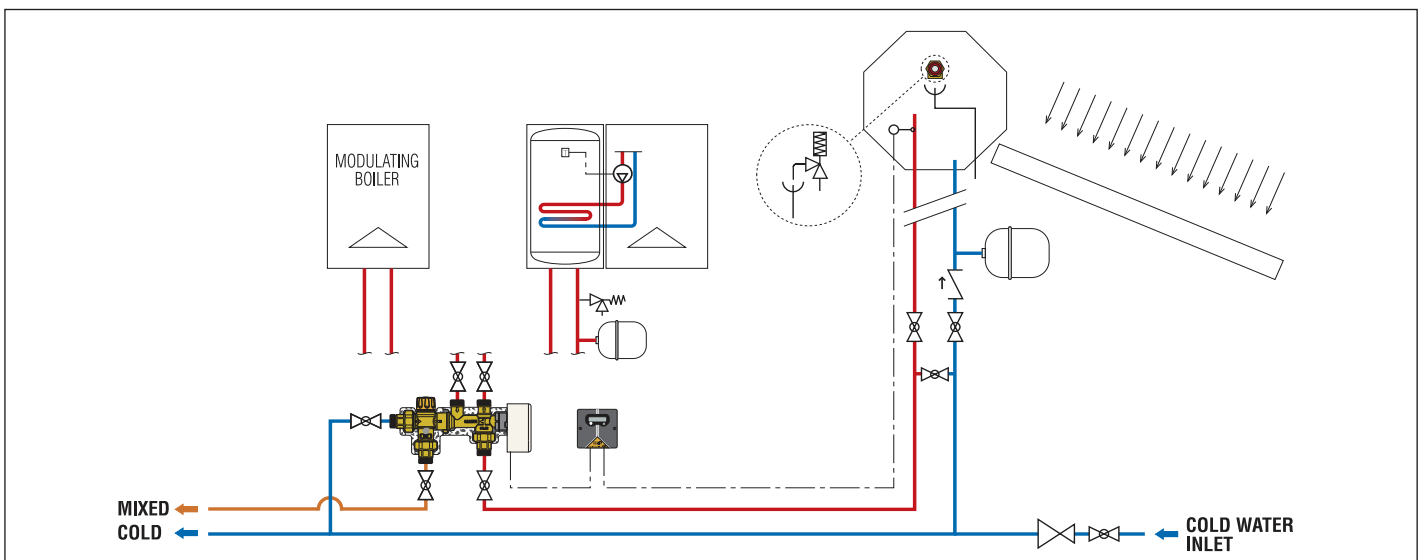

265



Thermostat with display showing storage temperature. For devices 264 and 265 series. Supply: 230 V (ac). Adjustable temperature range: 25-50°C. Factory setting: 45°C. Box protection class: IP 54.



Code			
265001		1	-

Accessories for connection kit 264 and 265 series.

Code	
264359	kit 264 series without thermostat and probe
265359	kit 265 series without thermostat and probe
F29525	box with switching 3 contact relay
F29466	Ø 15 mm contact probe
F29467	pocket for Ø 15 mm probe

SOLAR STORAGE-TO-BOILER THERMOSTATIC CONNECTION KIT

262 SOLARINCAL-T

tech. broch. 01164

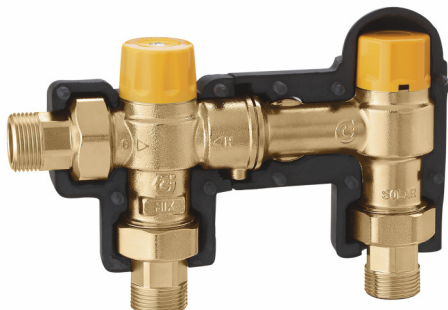

Function

A thermostatic diverter valve, at the kit inlet, receives hot water coming from the solar water storage. Depending on the temperature setting, the valve diverts the water automatically and in a proportional manner towards the user circuit or the boiler with storage circuit, with thermal integration. The valve modulates the flow rates to optimise the energy contained in the solar storage and reduces boiler operation times to a minimum. A thermostatic anti-scald mixing valve, at the kit outlet, constantly controls and limits the temperature of the water sent to the user.

Hydraulic diagrams

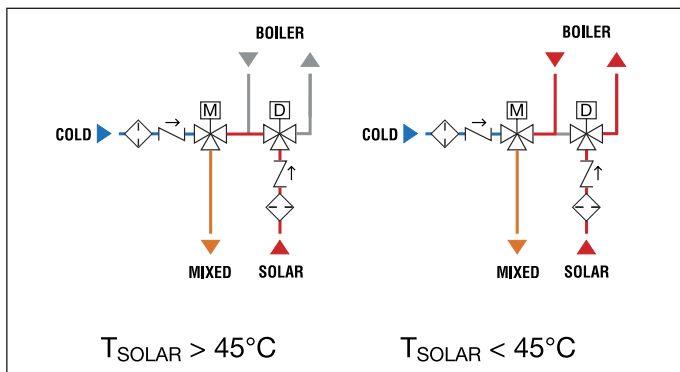

Solar storage-to-boiler connection kit, with thermal integration.

- Consisting of:
 - thermostatic anti-scald mixing valve, adjustable with knob, for solar thermal systems. Complete with strainers and check valves at the inlets.
 - thermostatic diverter valve;
 - pre-formed shell protective cover.

Diverter-to-mixing valve coupling with adjustable position of the inlet and outlet connections.

Mixing valve

CR dezincification resistant alloy body.
 Max. working pressure: 10 bar.
 Adjustment temperature range: 35–55°C.
Max. inlet temperature: 100°C.
 Performance to standards NF 079 doc. 8, EN 15092, EN 1111, EN 1287.

Diverter valve

Brass body.
 Max. working pressure: 10 bar.
 Factory setting: 45°C.
Max. inlet temperature: 100°C.

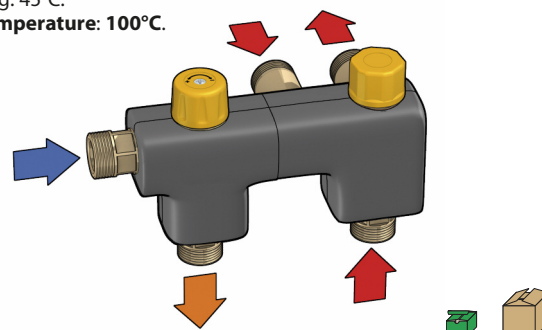

Code	Size	Quantity	Notes
262350	3/4"	1	-
F29384	mixing valve spare for 262 and 265 series	1	-

NEW



262 SOLARINCAL-T

tech. broch. 01164

Solar storage-to-boiler connection kit, with thermal integration. Without shell protective cover.

Code	Size	Quantity	Notes
262342	1/2"	1	-

Application diagram of SOLARINCAL-T kit 262 series

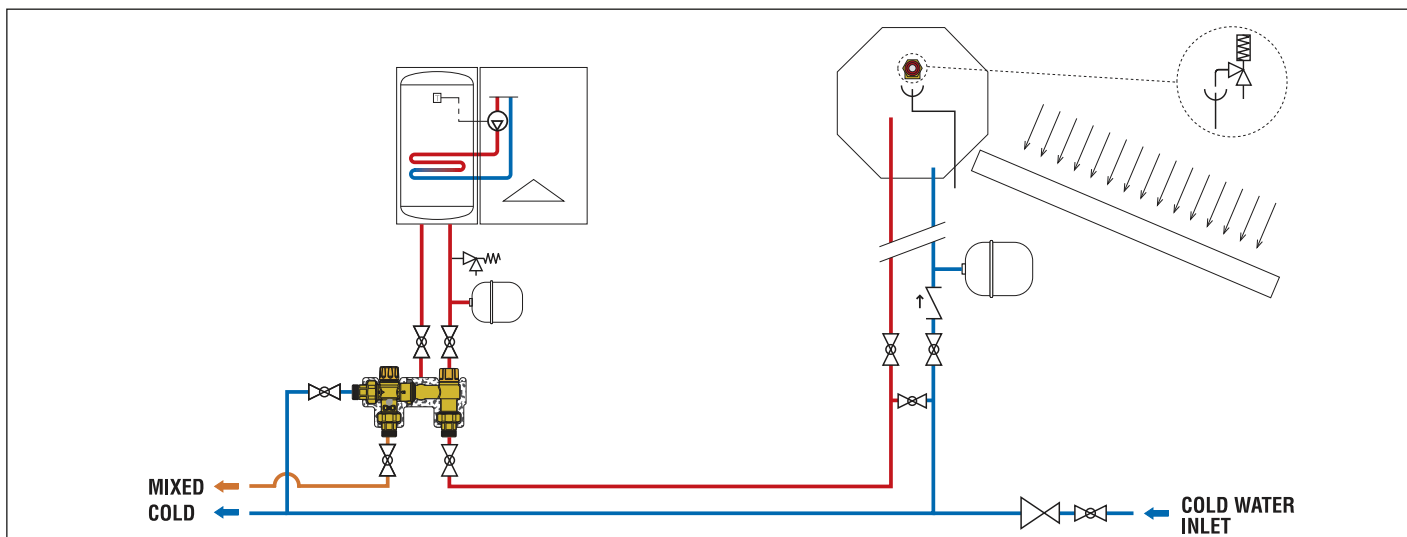

SOLAR STORAGE-TO-BOILER THERMOSTATIC CONNECTION KIT

263
SOLARINCAL-T PLUS

tech. broch. 01164



Function

A thermostatic diverter valve, at the kit inlet, receives hot water coming from the solar water storage. Depending on the temperature setting, the valve diverts the water automatically and proportionally towards the user circuit or the **instantaneous boiler circuit, with thermal integration**. The valve modulates the flow rates to optimise the energy contained in the solar storage and reduces boiler operation times to a minimum.

A specific thermostatic control device limits the boiler inlet temperature to prevent it being switched on and off too often, which leads to hunting and irregular operation.

A thermostatic anti-scald mixing valve, at the kit outlet, constantly controls the temperature of the water sent to the user.

Hydraulic diagrams

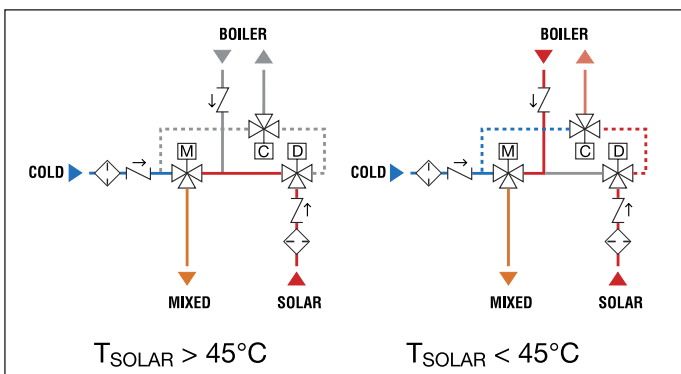

Solar storage-to-boiler connection kit, **with thermal integration**.

Consisting of:

- thermostatic anti-scald mixing valve, adjustable with knob, for solar thermal systems. Complete with strainers and check valves at the inlets;
- thermostatic diverter valve;
- thermostatic control device;
- pre-formed **shell protective cover**.

Mixing valve

CR dezincification resistant alloy body.

Max. working pressure: 10 bar.

Adjustment temperature range: 35–55°C.

Max. inlet temperature: 100°C.

Performance to standards NF 079 doc. 8, EN 15092, EN 1111, EN 1287.

Diverter valve

CR dezincification resistant alloy body.

Max. working pressure: 10 bar.

Factory setting: 45°C.

Max. inlet temperature: 100°C.

Control device

CR dezincification resistant alloy body.

Factory setting: 30°C.

Max. inlet temperature: 85°C.

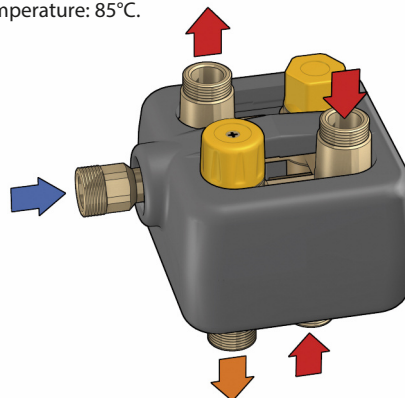

Code

263350 3/4"



1

-

Application diagram of SOLARINCAL-T Plus kit 263 series

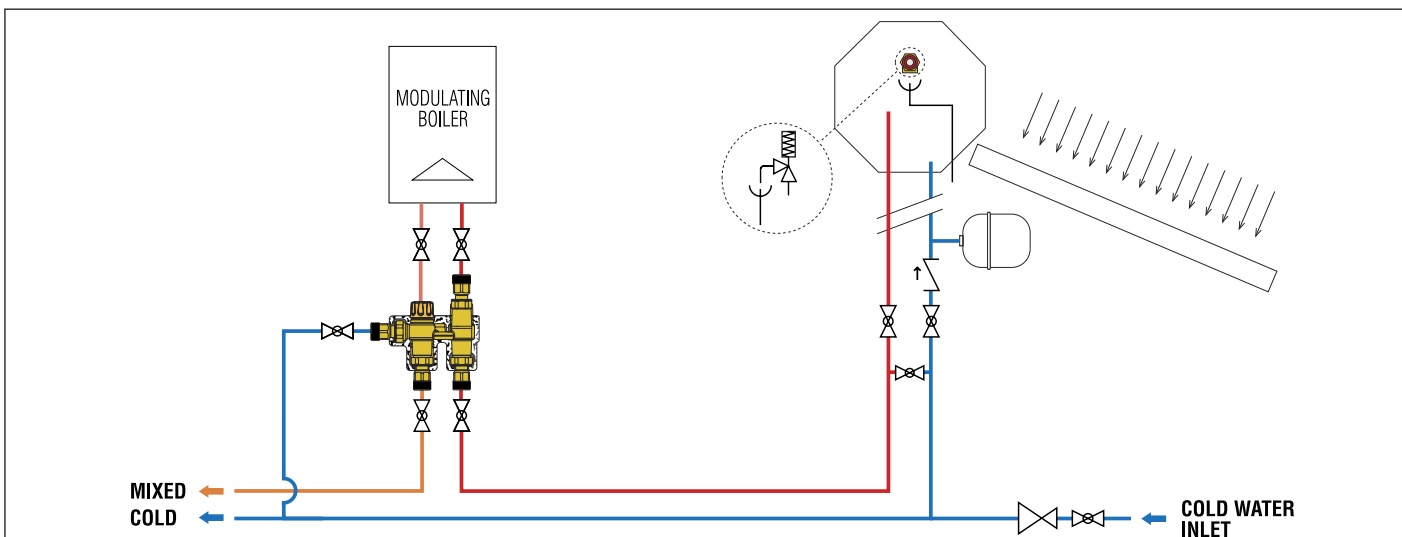

TEMPERATURE AND PRESSURE RELIEF VALVE



309

tech. broch. 01147

Temperature and pressure relief valve.
For solar thermal systems, to protect the hot water storage.
 CR dezincification resistant alloy body.
 Chrome plated.
 Setting temperature: 90°C.
 Discharge rating:
 1/2" x Ø 15: 10 kW.
 3/4" x Ø 22: 25 kW.
 Settings: 6 - 7 - 10 bar.
Settings certified to EN 1490: 7 - 10 bar.



Code

Code	1/2" M x Ø 15	6 bar	1	20
309461	1/2" M x Ø 15	7 bar	1	20
309471	1/2" M x Ø 15	10 bar	1	20
309401	3/4" M x Ø 22	6 bar	1	20
309561	3/4" M x Ø 22	7 bar	1	20
309571	3/4" M x Ø 22	10 bar	1	20

Function

The temperature and pressure relief valve controls and limits the temperature and pressure of the hot water contained in a solar domestic water storage heater and prevents it to reach temperatures over 100°C, with the formation of steam.

On reaching the settings, the valve discharges a sufficient amount of water into the atmosphere so that the temperature and pressure return within the system's operating limits.

As the temperature and pressure decrease, the opposite action occurs with the valve subsequently reclosing within the set tolerances.

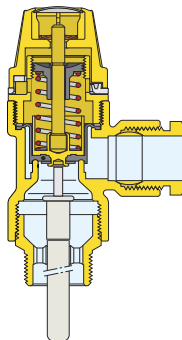

Product certification in accordance with European Standard EN 1490

European Standard EN 1490: 2000, entitled "Building valves - Combined temperature and pressure relief valves - Tests and requirements", describes the constructional and performance specifications that TP relief valves must have. Caleffi 309 series TP relief valves for solar systems are certified by Buildcert (UK) to comply with the requirements of the European Standard EN 1490.

Application diagram of valve 309 series on a solar hot water storage

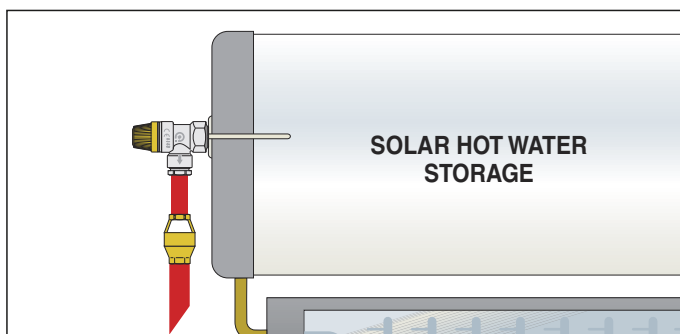

ANTI-FREEZE SAFETY DEVICE



**603
ICE**

Anti-freeze safety device.
For solar thermal systems, to protect the hot water storage.
 CR dezincification resistant alloy body.
 Max. working pressure: 10 bar.
 Ambient temperature range: -30-90°C.
 Opening temperature: 3°C.
 Closing temperature: 4°C.



Code

603040 1/2" F with nut



1 50

Function

The anti-freeze safety device prevents ice build-up in domestic water circuits, thereby avoiding potential damage to storage tanks and pipes

When the minimum ambient intervention temperature is reached, it automatically opens a minimum passage of water toward the drain, enabling a small continuous flow of water at the inlet; this prevents any risk of freezing.

When the ambient temperature increases or in the event of contact with warmer water, the opposite action occurs, causing the device to shut off and circuit normal operating conditions to be restored.

Closed position

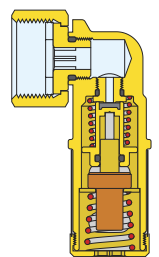

Open position

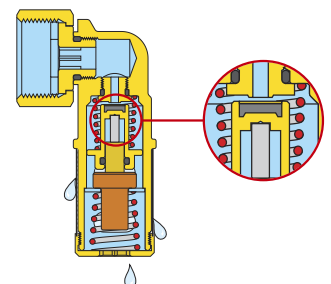

Application diagram of device 603 series on a domestic water circuit

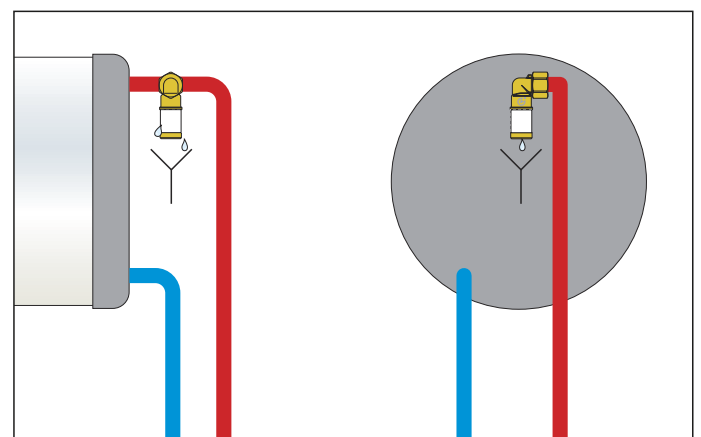

COMPONENTS FOR HEAT PUMP SYSTEMS

This diagram is just an indication

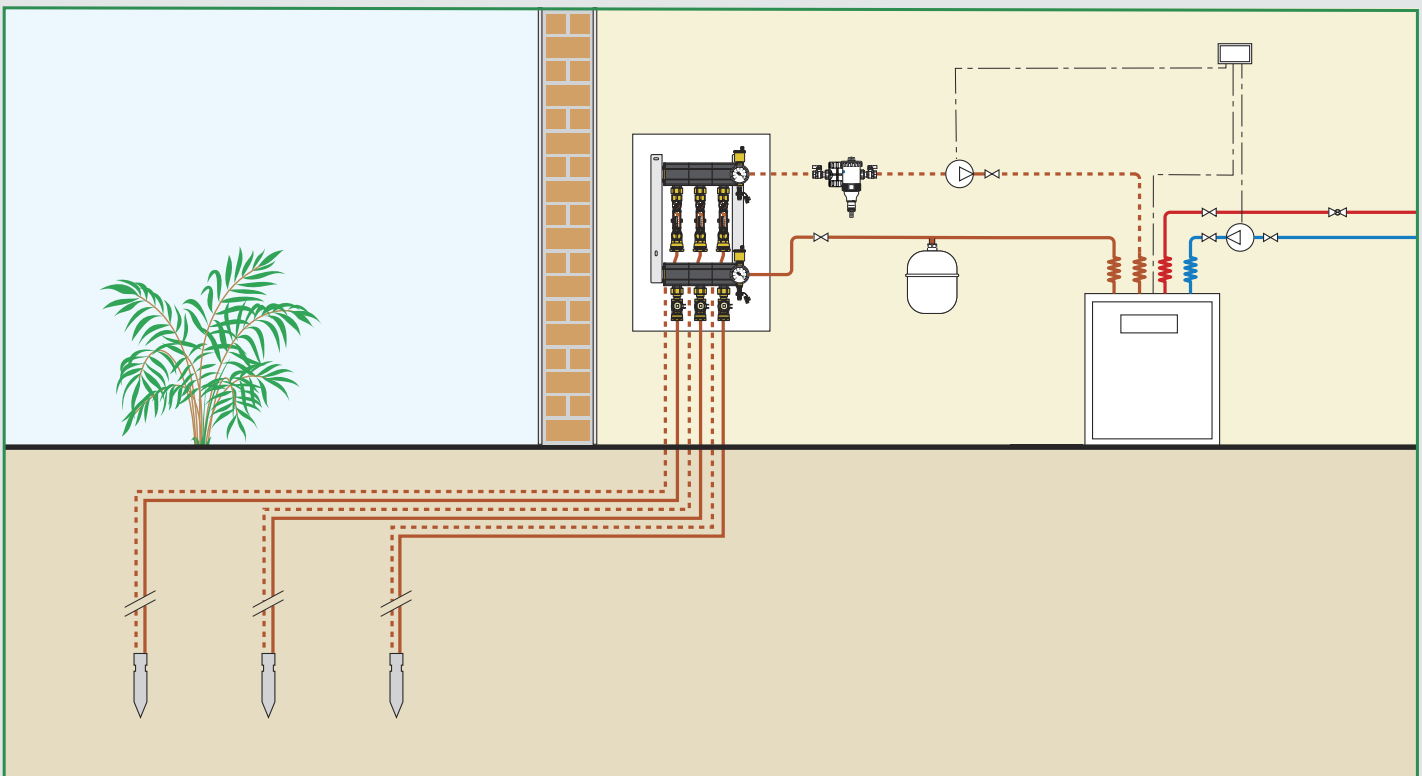
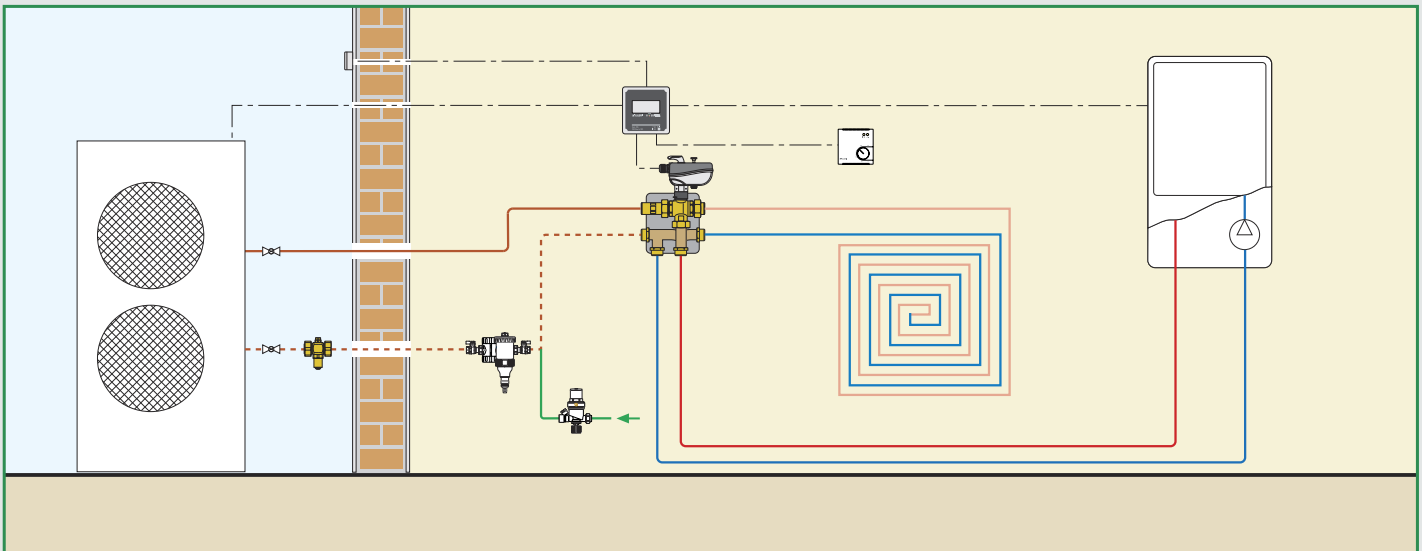

- Integration unit, HYBRICAL®
- Anti-freeze protection
- Preassembled geothermal manifold
- Modular geothermal manifold
- Shut-off and balancing devices



The products in the CALEFFI GEO® series have been specifically designed for use in heat pump systems. In **ground source heat pumps** a mixture of water and anti-freeze fluid is generally used to protect against freezing temperatures. The components are made with high-performance materials for this type of applications.

INTEGRATION UNIT

106 HYBRICAL® tech. broch. 01233



Heat pump-boiler integration unit. **With insulation.**
 Consisting of:
 - diverter valve,
 - connection kit,
 - electronic regulator,
 - outside probe.

Supply: 230 V (ac).
 Max. working pressure: 10 bar.
 Temperature range: -10-110°C.
 Medium: water, glycol solutions.
 Max. percentage of glycol: 50%.



Code	Conn.		
106160	1"	1	-

106 HYBRICAL® tech. broch. 01233



Heat pump-boiler integration unit. **With insulation.**
 Consisting of:
 - diverter valve,
 - electronic regulator,
 - outside probe.

Supply: 230 V (ac).
 Max. working pressure: 16 bar.
 Temperature range: -10-110°C.
 Medium: water, glycol solutions.
 Max. percentage of glycol: 50%.



Code	Conn.		
106170	1 1/4"	1	-
106180	1 1/2"	1	-
106190	2"	1	-

Operating principle

The integration unit is composed of a diverter valve and manifold kit combined to a digital regulator equipped with outside probe. The regulator receives the temperature signal from the outside probe and, when the minimum pre-set temperature value is reached, activates the diverter valve towards the boiler circuit. When the outside air temperature rises above the pre-set temperature value, the valve is diverted again towards the heat pump system.

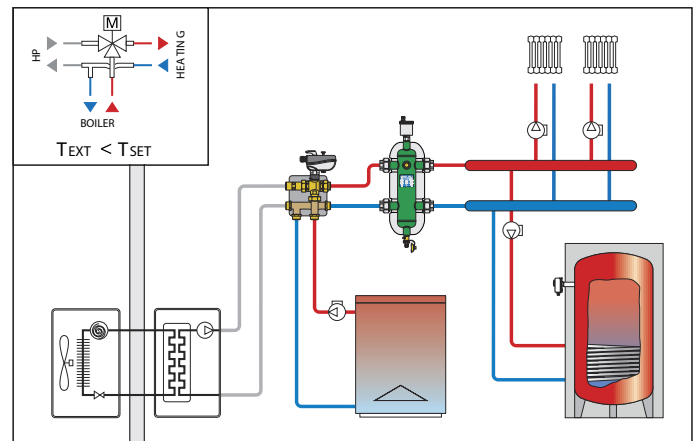
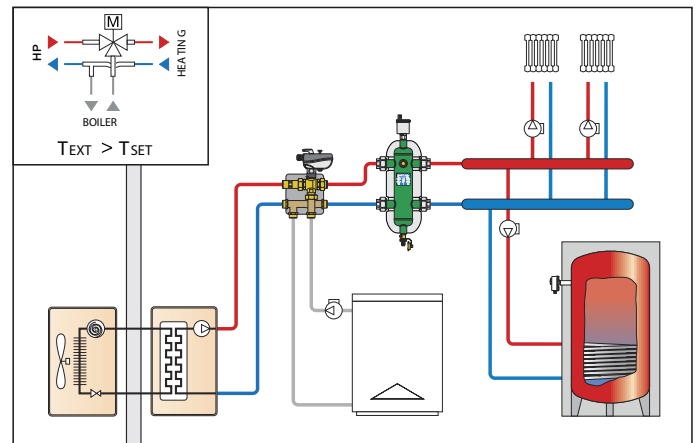

DIVERTER KIT



106 HYBRICAL®

Diverter kit for heat pump.

With insulation.

Consisting of:

- diverter valve,
- connection kit.

Supply: 230 V (ac).

Max. working pressure: 10 bar.

Temperature range: -10–110°C.

Medium: water, glycol solutions.

Max. percentage of glycol: 50%.



Code Conn.

106060 1"



1 -

ANTI-FREEZE PROTECTION



108

Anti-freeze valve. Brass body.

Max. working pressure: 10 bar.

Temperature range: 0–65°C.

Ambient temperature range: -30–60°C.

Opening temperature: 3°C.

Closing temperature: 4°C.



Code Conn.

108601 1"

108701 1 1/4"

108801 1 1/2"



1 25

1 20

1 20

Operating principle

The diverter kit allows to easily connect the 3 circuits together (2 inlets and 1 outlet) without having to overcome pipes.

The diverter valve has very low head losses, in relation to the rated flow rates normally used, and features short operating times: it allows therefore a fast system commissioning and prevents any water-hammer.

The valve is coupled to an actuator fitted with microswitches that can be used to activate and deactivate devices according to the working position of the valve.

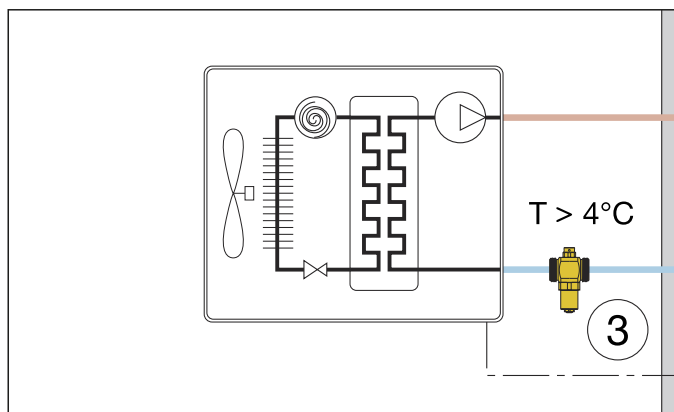
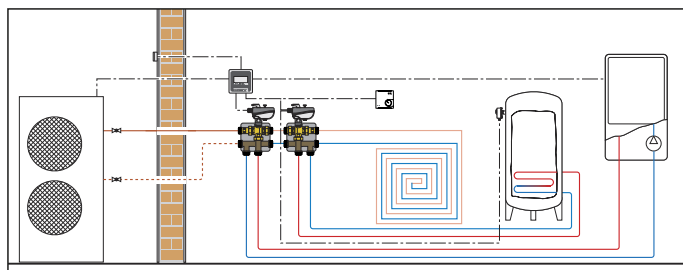

PREASSEMBLED GEOTHERMAL DISTRIBUTION MANIFOLD

110

Preassembled geothermal manifold.
Complete with:

- automatic air vents;
- temperature gauges Ø 80 mm;
- fill/drain cocks;
- flow and return manifolds in polymer;
- blind end plugs with insulation;
- stainless steel wall brackets;
- set of labels for direction of flow and circuit identification;
- wall fixing anchors.

tech. broch. 01221

Max. working pressure: 6 bar.
Max. hydraulic test pressure: 10 bar.
Temperature range: -10–60°C.
Ambient temperature range: -20–60°C.
Medium: water, glycol solutions, saline solutions.
Max. percentage of glycol: 50%.
Manifold DN 50.
Max. flow rate: 7 m³/h.
Outlet centre distance: 100 mm.
Outlet connections with mechanical seal for shut-off valves
111 series, balancing valves 112 series and flow meters 113 series.

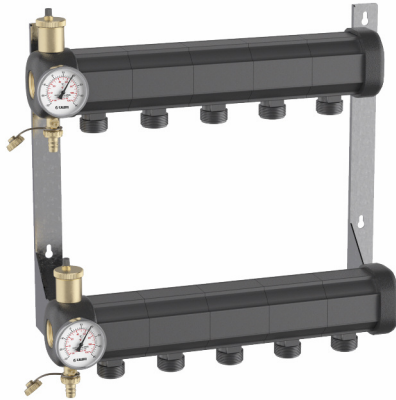

Code	Outlet connection				
1107B5	2 circuits	1 1/4"	42 p,2,5 TR	1	–
1107C5	3 circuits	1 1/4"	42 p,2,5 TR	1	–
1107D5	4 circuits	1 1/4"	42 p,2,5 TR	1	–
1107E5	5 circuits	1 1/4"	42 p,2,5 TR	1	–
1107F5	6 circuits	1 1/4"	42 p,2,5 TR	1	–
1107G5	7 circuits	1 1/4"	42 p,2,5 TR	1	–
1107H5	8 circuits	1 1/4"	42 p,2,5 TR	1	–

For more than 8 outlet circuits, see the modular manifold

MODULAR GEOTHERMAL DISTRIBUTION MANIFOLD

110

tech. broch. 01221

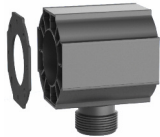

Modular manifold single module in polymer.
Max. working pressure: 6 bar.
Max. hydraulic test pressure: 10 bar.
Working temperature range: -10–60°C.
Ambient temperature range: -20–60°C.
Medium: water, glycol solutions, saline solutions.
Max. percentage of glycol: 50%.
Manifold DN 50.
Outlet connection: 42 p,2,5 TR.
Outlet connections with mechanical seal for shut-off valves 111 series, balancing valves 112 series and flow meters 113 series.

Code		
110700	1	–

110

tech. broch. 01221

Assembly kit for modular manifolds. Complete with:

- brass end fitting with automatic air vent, fill/drain cock;
- brass blind end plug;
- pre-formed shell insulation;
- screws and bolts for tie-rods and brackets;
- set of labels for direction of flow and circuit identification;
- temperature gauge with pocket (-30–50°C);
- No. 2 seal gaskets.

Max. working pressure: 6 bar.
System test max. pressure: 10 bar.
Temperature range: -10–60°C.
Ambient temperature range: -20–60°C.
Medium: water, glycol solutions, saline solutions.
Max. percentage of glycol: 50%.
Connections: 1 1/4" F.



Code		
110750	1	–

110

tech. broch. 01221



Stainless steel tie-rods for assembling modular manifolds.
M8 threaded stainless steel bar.

Code			
110012	for manifold with 2 circuits	1	–
110013	for manifold with 3 circuits	1	–
110014	for manifold with 4 circuits	1	–
110015	for manifold with 5 circuits	1	–
110016	for manifold with 6 circuits	1	–
110017	for manifold with 7 circuits	1	–
110018	for manifold with 8 circuits	1	–
110019	for manifold with 9 circuits	1	–
110020	for manifold with 10 circuits	1	–
110021	for manifold with 11 circuits	1	–
110022	for manifold with 12 circuits	1	–

110

tech. broch. 01221



Pair of stainless steel brackets to secure modular manifolds.
Rapid wall coupling system.
System for rapidly coupling the manifold on the brackets.
With screws and plugs.

Code		
110001	1	–

SHUT-OFF AND BALANCING DEVICES FOR GEOTHERMAL MANIFOLD 110 SERIES



112

tech. broch. 01235

Balancing valve with flow meter. Complete with fitting for polyethylene pipe. Direct reading of flow rate. Ball valve for flow rate setting. Graduated scale flow meter with magnetic movement flow rate indicator. Brass valve body and flow meter. Connection to manifold: female connections with captive nut 42 p.2,5 TR. Max. working pressure: 10 bar. Temperature range: -10–40°C. Ambient temperature range: -20–60°C. Medium: water, glycol solutions, saline solutions. Max. percentage of glycol: 50%. Accuracy: ±10%.

Code		Scale (m ³ /h)		
112621	42 p.2,5 TR x Ø 25	0,3–1,2	1	–
112631	42 p.2,5 TR x Ø 32	0,3–1,2	1	–
112641	42 p.2,5 TR x Ø 40	0,3–1,2	1	–



113

tech. broch. 01236

Float flow meter. Complete with fitting for polyethylene pipe. Direct reading of flow rate. Ball valve for flow rate setting. Brass body. Connection to manifold: female connection with captive nut 42 p.2,5 TR. Max. working pressure: 10 bar. Working temperature range: -10–40°C. Ambient temperature range: -20–60°C. Medium: water, glycol solutions, saline solutions. Max. percentage of glycol: 50%. Accuracy: ±10%.

Code		Scale (m ³ /h)		
113621	42 p.2,5 TR x Ø 25	0,3–1,2	1	–
113631	42 p.2,5 TR x Ø 32	0,3–1,2	1	–



112

tech. broch. 01235

Insulation for balancing valves. Material: closed cell expanded PE-X. Thickness: 10 mm. Density: inner part 30 kg/m³, outer part 80 kg/m³. Thermal conductivity (DIN 52612): at 0°C: 0,038 W/(m·K); at 40°C: 0,045 W/(m·K). Coefficient of resistance to water vapour (DIN 52615): > 1.300. Working temperature range: 0–100°C. Reaction to fire (DIN 4102): class B2.

Code	Use		
112001	Ø 25 - Ø 32	1	–
112003	Ø 40	1	–



113

tech. broch. 01236

Insulation for float flow meter. Material: closed cell expanded PE-X. Thickness: 10 mm. Density: inner part 30 kg/m³, outer part 80 kg/m³. Thermal conductivity (DIN 52612): at 0°C: 0,038 W/(m·K); at 40°C: 0,045 W/(m·K). Coefficient of resistance to water vapour (DIN 52615): > 1.300. Working temperature range: 0–100°C. Reaction to fire (DIN 4102): class B2.

Code	Use		
113001	Ø 25 - Ø 32	1	–

871



Ball valve complete with fitting for polyethylene pipe. Brass body. Connection to manifold: female connection with captive nut 42 p.2,5 TR. Max. working pressure: 16 bar. Working temperature range: -10–40°C. Ambient temperature range: -20–60°C. Medium: water, glycol solutions, saline solutions. Max. percentage of glycol: 50%. Fitted for 111 series insulation.

Code			
871025	42 p.2,5 TR x Ø 25	1	–
871032	42 p.2,5 TR x Ø 32	1	–
871040	42 p.2,5 TR x Ø 40	1	–



110

Union with gasket. Max. working pressure: 16 bar. Max. working temperature: 40°C.

Code			
110050	42 p.2,5 TR x 3/4"	1	–
110060	42 p.2,5 TR x 1"	1	–

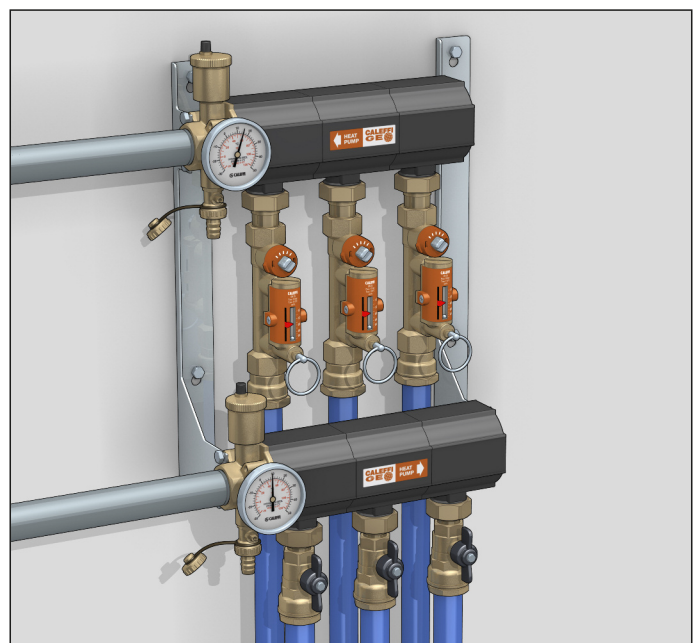

The use of a flow meter greatly simplifies the process of system balancing, since the flow rate can be measured and controlled at any time and there is no need for differential pressure gauges or reference charts.

SHUT-OFF AND BALANCING DEVICES FOR GEOTHERMAL MANIFOLD 110 SERIES



111

tech. broch. 01234

Shut-off ball valve fitted for integrated flow rate measuring sensor. Complete with fitting for polyethylene pipe. Brass body. Polymer top plug. Connection to manifold: female connection with captive nut 42 p.2,5 TR. Max. working pressure: 6 bar. Max. hydraulic test pressure: 10 bar. Temperature range: -10–40°C. Ambient temperature range: -20–60°C. Medium: water, glycol solutions, saline solutions. Max. percentage of glycol: 50%.

Code

111620	42 p.2,5 TR x Ø 25	1	–
111630	42 p.2,5 TR x Ø 32	1	–
111640	42 p.2,5 TR x Ø 40	1	–



111

tech. broch. 01234



Insulation for shut-off valves. Material: closed cell expanded PE-X. Thickness: 10 mm. Density: inner part 30 kg/m³, outer part 80 kg/m³. Thermal conductivity (DIN 52612): at 0°C: 0,038 W/(m·K); at 40°C: 0,045 W/(m·K). Coefficient of resistance to water vapour (DIN 52615): > 1.300. Temperature range: 0–100°C. Reaction to fire (DIN 4102): class B2.

Code

Use

111001	Ø 25 - Ø 32	1	–
111003	Ø 40	1	–



130

tech. broch. 01234



Flow rate electronic measuring station for connecting sensor with Vortex effect. Complete with:
 - box;
 - power supply unit;
 - control lever;
 - measuring sensor with Vortex effect;
 - connecting cable;
 - clip and lock.

Rechargeable battery NiMH 9 V. Complete with battery charger. Flow rate scale: l/h - l/min - GPM. Flow rate range: 300–1400 l/h. Accuracy direct reading of flow rate and sensor with Vortex effect: ±10%. Protection class: IP 44.

Code

130010		1	4
--------	--	---	---



111

tech. broch. 01234



Integrated flow rate measuring sensor with Vortex effect. Accuracy reading of flow rate: ±10%.

Code

111010		1	–
--------	--	---	---



111

tech. broch. 01234



Control lever for shut-off valves. Polymer body.

Code

111002		1	–
--------	--	---	---



To exchange this plug with the sensor it is necessary to:
 1. Close the valve using the provided knob.
 2. Remove the lock and the clip and then pull out the cap.

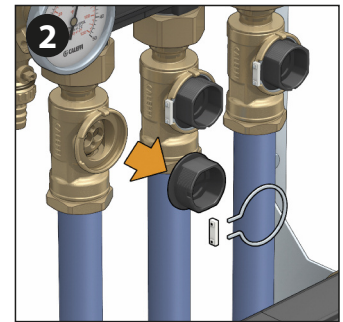
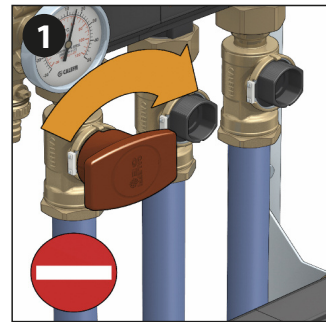

3. Insert the measuring sensor and retain it with the clip and the lock.
 4. Reopen the valve with the knob.

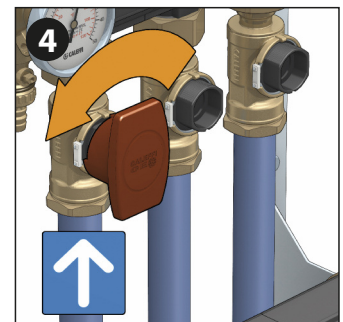
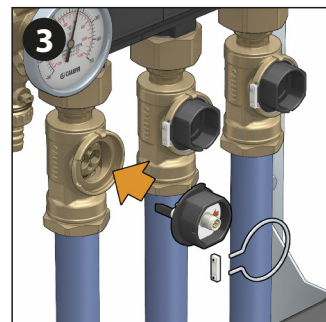

5. After carrying out these operations on all the outlets, it is possible to connect the electronic measurer to the sensor of the first branch and measure the corresponding flow rate. The flow rate is adjusted by regulating, with the special knob, the shut-off valve on the return manifold in correspondence with the same circuit until the instrument indicates the design setting.
 6. This operation must be repeated on the following branches to obtain the desired flow rate.

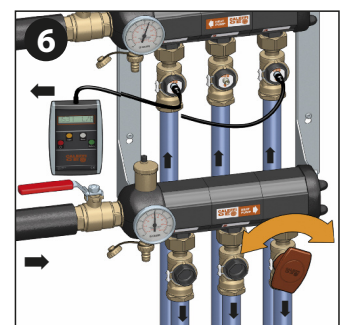
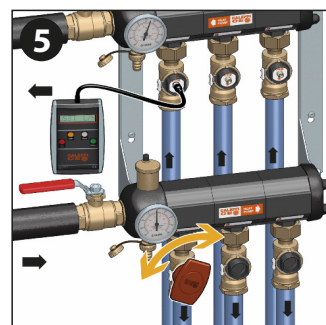

During the flow rate measurement, the sensor creates no significant head losses and therefore causes no significant changes in the actual flow rate.

After balancing, disconnect the electronic measurer and put the shut-off valves back into their standard operating condition as follows:

7. Close the valve with the knob (see figure 1).
 8. Remove the lock, the clip and extract the sensor (see figure 2).
 9. Fit the plug back in and secure it with the seal ring and the clip (see figure 3).
 10. Reopen the valve with the knob (see figure 4). Repeat the process for all the circuits.

COMPONENTS FOR BIOMASS SYSTEMS

This diagram is just an indication

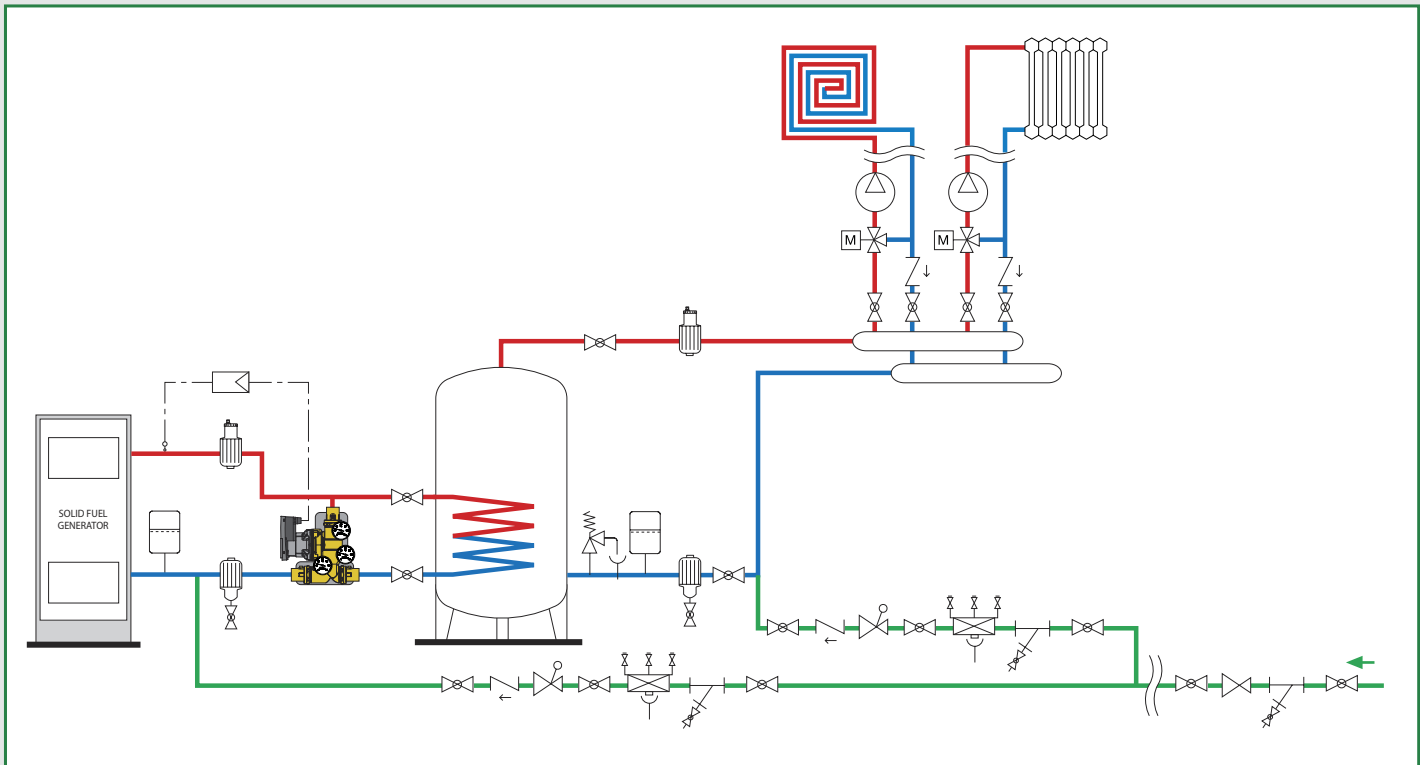

Safety devices

Anti-condensation valve

Anti-condensation circulation unit

Anti-condensation recirculation and distribution unit

Connection and energy management unit (heating version)

Connection and energy management unit (heating and domestic hot water with storage version)

Connection and energy management unit (heating and instantaneous hot water version)

Digital regulator for systems with solid fuel generator



The CALEFFI BIOMASS® product series has been created specifically to be used in circuits of systems with wood solid fuel generators, operating at high temperature with water or glycol solutions as thermal medium. The materials of the components and their performance take account of the specific system needs in terms of efficiency and safety of the generators and systems.

SAFETY DEVICES



542

tech. broch. 01001

Temperature relief valve, with fail-safe action. Manual reset for burner switch off or alarm activation. Working pressure: $0,3 \text{ bar} \leq P \leq 10 \text{ bar}$. Temperature range: 5–100°C. Setting temperature: 98°C, 99°C. Certified and calibrated to INAIL. Discharge rating:
 1 1/2" x 1 1/4" - 136 kW.
 1 1/2" x 1 1/2" - 419 kW.



Code	Setting			
542870	1 1/2" M x 1 1/4" F 98°C		1	10
542880	1 1/2" M x 1 1/2" F 99°C		1	10

Function

The temperature relief valve discharges the system water on reaching the setting temperature. Equipped with positive action. It can be used with non-pulverized solid fuel generators with open or closed vessel in accordance with current regulations.

INAIL - Ex ISPEL reference standards

According to the provisions of Collection R Ed. 2009, concerning "central heating systems using hot water with temperatures no greater than 110°C and a maximum nominal heat output greater than 35 kW", the use of the temperature relief valve is contemplated in the following cases:

Open vessel systems

- Systems with generators stoked with non-pulverized solid fuel, in place of the consumption water heater or emergency exchanger (chap. R.3.C., point 2.1, letter i2).

Closed vessel systems

- Thermal systems with generators stoked with non-pulverized solid fuels up to a nominal heat output of 100 kW with partial cut-off in place of the residual power dissipation device (chap. R.3.C., point 3.2).

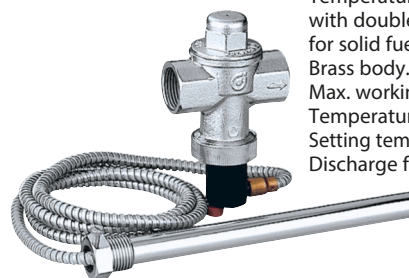
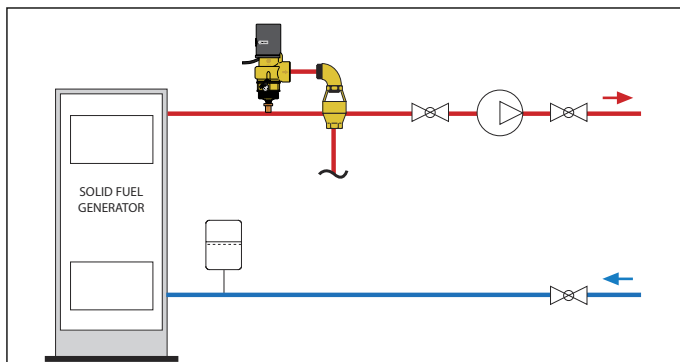
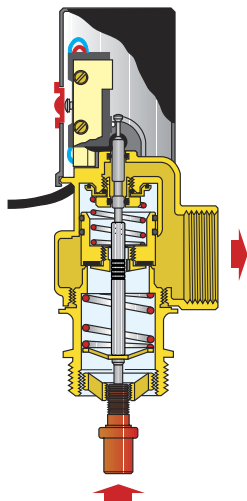

543

tech. broch. 01057

Temperature safety relief valve, with double safety sensor, for solid fuel generators. Brass body. Chrome plated. Max. working pressure: 10 bar. Temperature range: 5–110°C. Setting temperature: 98°C (0/-4°C). Discharge flow rate with Δp of 1 bar and $T=110^\circ\text{C}$: 3000 l/h. Capillary length: 1300 mm. Certified to EN 14597.



Code	Setting			
543513	3/4" F 98°C		1	10
543503	3/4" F 98°C yellow brass body		1	10

Function

The temperature safety relief valve limits the water temperature in solid fuel generators equipped with a built-in storage or emergency exchanger (for immediate cooling). On reaching the setting temperature, the valve opens the flow of mains water through the emergency exchanger or built-in storage unit, so as to draw off the excess heat and thereby lower the temperature of the system water contained in the boiler jacket.

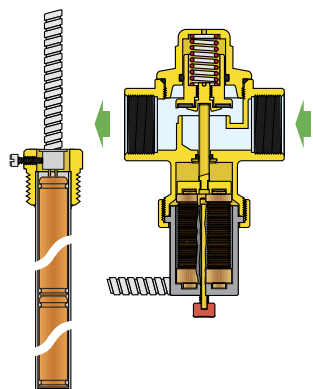

Reference standards

Its use is contemplated in the INAIL - Ex ISPEL standards, Collection R - ed. 2009, chapter R.3.C., point 2.1, letter i2; point 3.1, letter i; point 3.3. The valve complies with EN 14597, it can be combined with solid fuel generators with a heat output of less than 100 kW, used according to the system provisions of the standards EN 12828, UNI 10412-2 and EN 303-5.

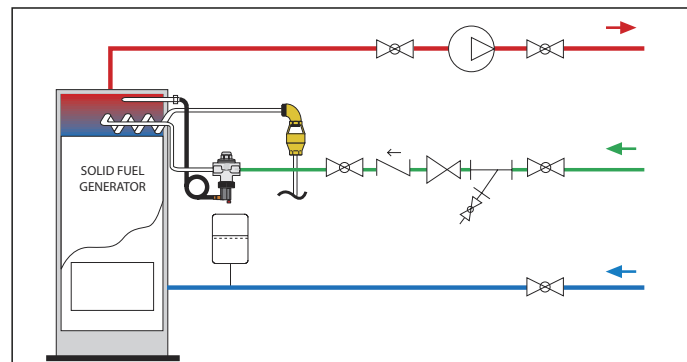

SAFETY DEVICES

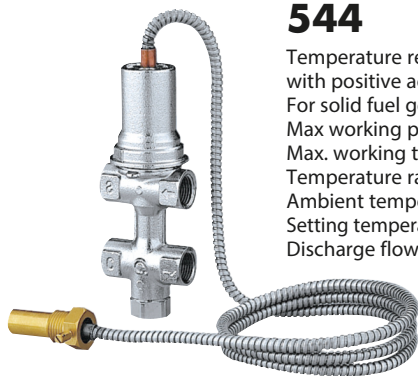

544

tech. broch. 01058

Temperature relief valve, with positive action with automatic filling. For solid fuel generators. Max working pressure: 6 bar. Max. working temperature: 110°C. Temperature range: 5–110°C. Ambient temperature range: 1–50°C. Setting temperature: 100°C (0/-5°C). Discharge flow rate with Δp of 1 bar and T=110°C: 1600 l/h. Capillary length: 1300 mm.

Code	Setting		
544400	1/2"	100°C	1 10

Function

On reaching the setting temperature, the temperature relief valve discharges the water of the system with a solid fuel generator. The device integrates in a single group a temperature relief valve with a positive safety remote sensor and a filling valve. The discharge of water enables limiting the system water temperature, while the filling inlet enables the replacement of the discharged flow rate.

Reference standards

Used when there is no emergency exchanger and for heat outputs < 35 kW (Italy).

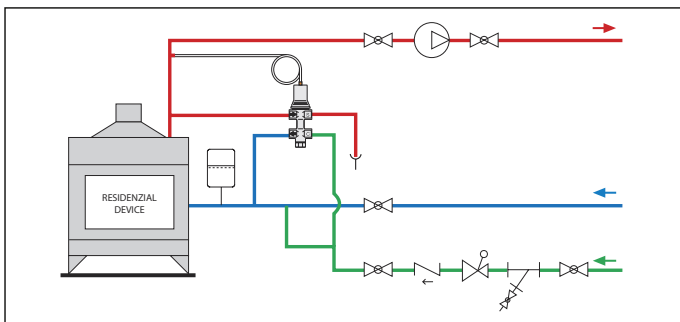
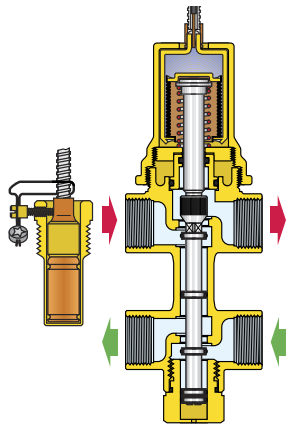

544

Temperature relief valve with automatic filling for solid fuel generators, with knob for manual discharge. Max. working pressure: 6 bar. Max. working temperature: 120°C. Setting temperature: 100°C (0/-5°C). Discharge flow rate with Δp of 1 bar and T=110°C: 1800 l/h.

Code	Setting		
544501	3/4"	100°C	1 -

Function

The device integrates in a single group a temperature relief valve and a filling valve that operate simultaneously by means of a sensor integrated in the valve body. On reaching the setting value, the valve opens the discharge outlet to eliminate the excess heat and, at the same time, the filling inlet to replace the discharged flow rate of the system water.

Reference standards

Used when there is no emergency exchanger and for heat outputs < 35 kW (Italy).

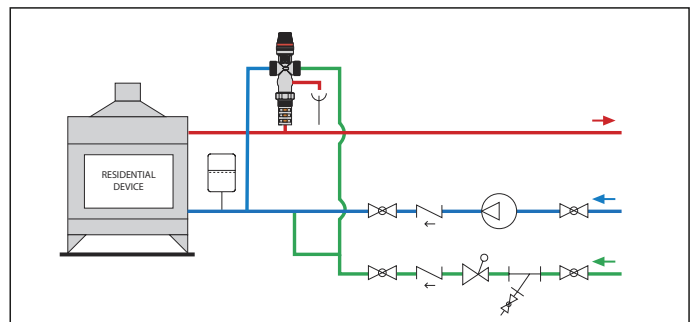
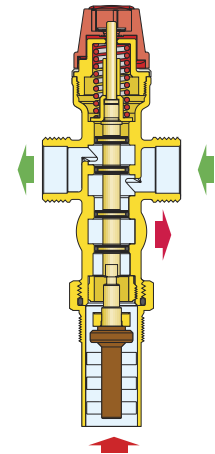

529

tech. broch. 01226

Draught regulating valve. Male threaded connection. Adjustment temperature range: 30–90°C. Certified to EN 14597.

Code		Pocket length (mm)		
529050	3/4" M ISO 7/1	58	1	10
529150	3/4" M ISO 7/1	58	1	10
529151	3/4" M ISO 7/1	78	1	10

Function

The draught regulating valve, installed on the generator with the thermostatic element immersed in the medium, automatically adjusts the flow rate of the comburent air to provide a more regular and complete combustion.

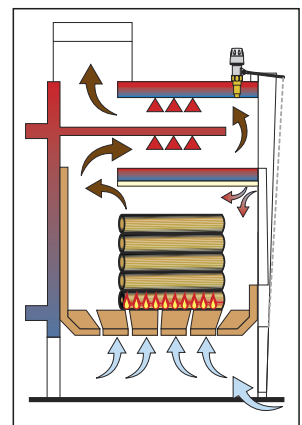

ANTI-CONDENSATION VALVE



280

tech. broch. 01223

Anti-condensation valve with thermostatic control of the return temperature to solid fuel generators. Brass body. Male union connections. Max. percentage of glycol: 50%. Max. working pressure: 10 bar. Temperature range: 5–100°C. Settings: 45°C, 55°C, 60°C, 70°C. Setting accuracy: ±2°C. By-pass complete closing temperature: $T_{mix} = T_{set} + 10^\circ C = Tr$.

PCT INTERNATIONAL APPLICATION PENDING

Code	DN	Connection	Kv (m³/h)		
28005.	20	3/4"	3,2	1	10
28026.*	20	1"	3,2	1	10
28006.	25	1"	9	1	5
28007.	32	1 1/4"	12	1	5

* Caution: same Kv value of 3/4" valve. For DN 20 valves, the max. suggested power output is 10 kW

Valve selection

The valve selection should be made according to the Kv value (corresponding to a specific DN body size) and not only according to the threaded connections. Given the system flow rate, the corresponding head losses on the valve should be calculated by using the Kv value. The sum of the head losses on the valve and the head losses of the rest of the system should be compatible with the available head of the generator pump.

Code completion

Setting	45°C	55°C	60°C	70°C
•	4	5	6	7



Spare thermostats for anti-condensation valve.

Code	Setting	Use		
F29629	45°C	code 28005. / 28026.	1	–
F29630	55°C	code 28005. / 28026.	1	–
F29631	60°C	code 28005. / 28026.	1	–
F29632	70°C	code 28005. / 28026.	1	–
F29633*	45°C	code 28006. / 28007.	1	–
F29634*	55°C	code 28006. / 28007.	1	–
F29635*	60°C	code 28006. / 28007.	1	–
F29636*	70°C	code 28006. / 28007.	1	–

* Utilizzare anche per serie 281, 282, 2850, 2851, 2853, 2855

Thermostat replacement to modify setting

The adjustment sensor can easily be removed for maintenance or to change the set, with no need to remove the valve body from the piping.

Installation

The valve can be fitted on both sides of the generator in any position, vertical or horizontal. Installation is recommended on the return to the generator in mixing mode; it is also allowed on the flow from the generator in diverter mode according to the needs of system control.

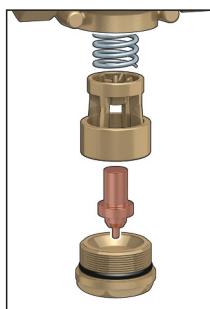

Function

The anti-condensation valve, used in heating systems with a solid fuel generator, automatically regulates at the set value the temperature of the water returning to the generator. Keeping the boiler at a high temperature prevents condensation of the water vapour contained in the flue gas. Condensation produces tarry deposits that, accumulating on the metal surfaces of the flue gas-system water exchanger, cause corrosion, reduce the thermal efficiency of the flue gas-system water exchanger and are a source of danger for the flue gas chimney as they are flammable. The anti-condensation valve gives the generator a longer life and ensures greater efficiency.

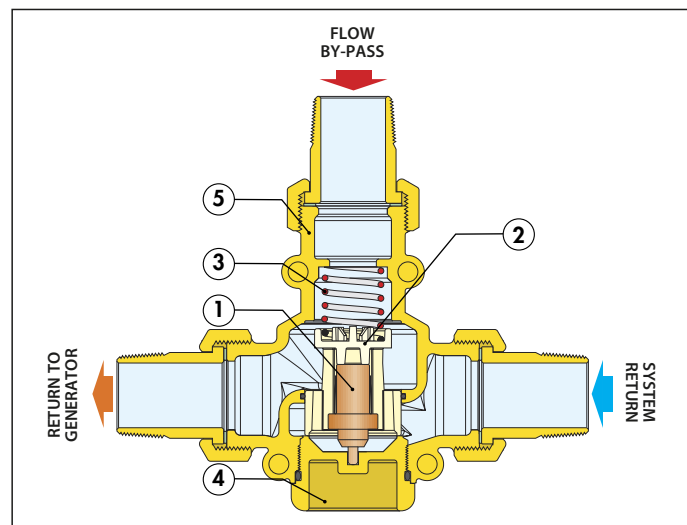
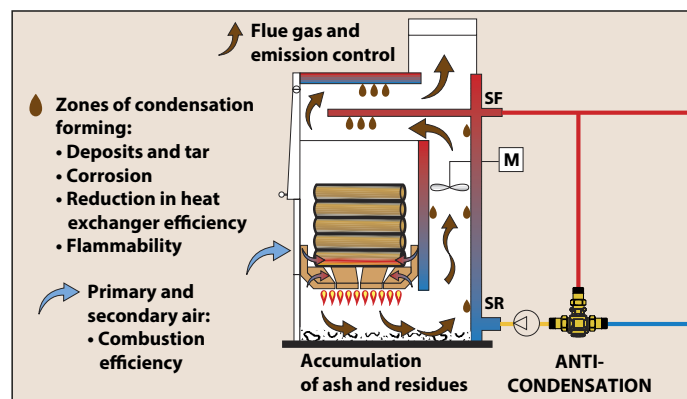

Characteristics components

- 1) Thermostatic sensor
- 2) Obturator
- 3) Spring
- 4) Plug
- 5) Valve body

Installation in mixing mode (anti-condensation)

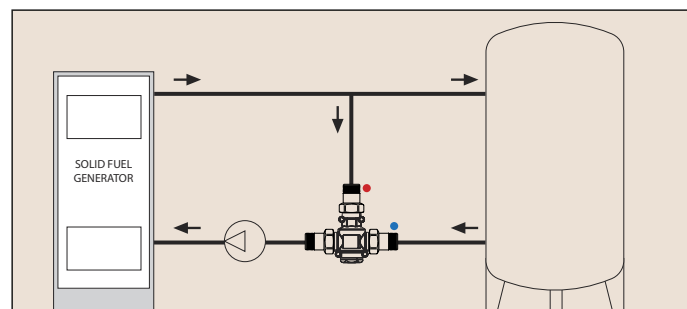

ANTI-CONDENSATION RECIRCULATION AND DISTRIBUTION UNIT

281

tech. broch. 01224

Anti-condensation recirculation and distribution unit, with thermostatic control of the return temperature to solid fuel generators. Brass body.

With insulation.

- Female union connections.
- Medium: water, glycol solutions.
- Max. percentage of glycol: 50%.
- Temperature range: 5–100°C.
- Max. working pressure: 10 bar.
- Max. recommended flow rate: 2 m³/h.
- Temperature gauge scale: 0–120°C.

Anti-condensation valve

- Temperature range: 5–100°C.
- Settings: 45°C, 55°C, 60°C, 70°C.
- Setting accuracy: ±2°C.
- By-pass complete closing temperature: $T_{mix} = T_{set} + 10°C = Tr.$

Pump

High-efficiency pump: YONOS PARA 25/6 RKC.

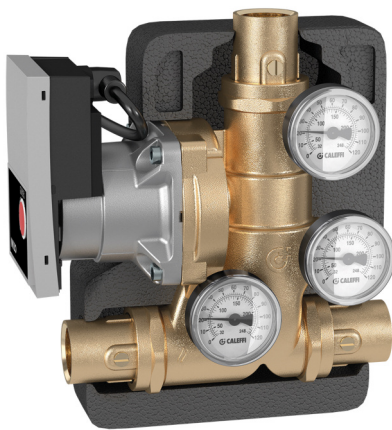

Code	DN	Connection			
28106.WYP	25	1" F	with pump YONOS PARA 25/6 RKC	1	–
28107.WYP	25	1 1/4" F	with pump YONOS PARA 25/6 RKC	1	–

Unit sizing

The unit should be selected according to the head available at the unit connections, depending on the DN, and not only according to the threaded connections. Given the system head losses, the available head of the unit pump should be evaluated.

Code			
F29806	spare rotor for unit 281 series	1	–

Code completion

Setting	45°C	55°C	60°C	70°C
•	4	5	6	7

For spare thermostats see page 266

Function

The anti-condensation recirculation and distribution unit enables the connection of the solid fuel generator to the user system (direct or with inertial storage). It controls the return temperature to the generator to avoid condensation, by means of the built-in thermostatic device.

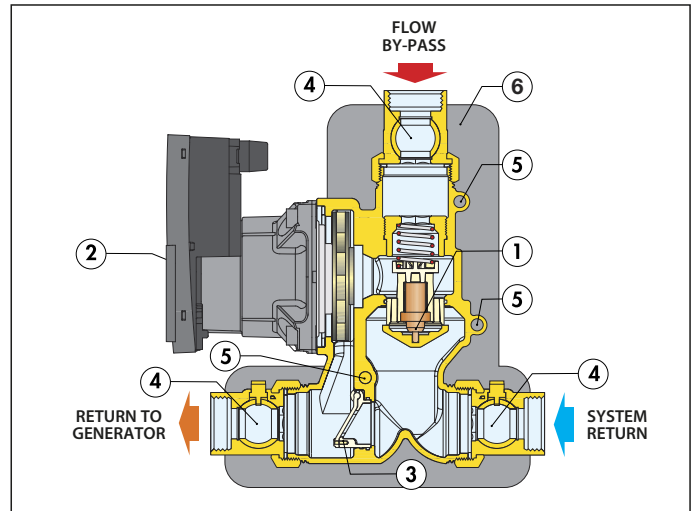

Characteristics components

- 1) Anti-condensation thermostatic device
- 2) High-efficiency pump
- 3) Natural circulation clapet valve
- 4) Union with built-in ball valve
- 5) Temperature gauge housing
- 6) Insulation

Construction details

Single casting and reversibility

The compact brass single casting, that houses the pump and functional components, enables immediate installation of the device, either on the right or left of the solid fuel generator, respecting the flow directions as shown. The temperature gauges can be extracted from the housings and re-inserted in the same position on the back side of the unit.

Anti-condensation valve

This device incorporates a thermostatic sensor to control the temperature of the water returning to the solid fuel generator so as to prevent condensation. The sensor has been specifically realised to be removed from the valve body for maintenance or replacement if necessary.

Natural circulation clapet valve

The function of this clapet device is to ensure natural circulation of the medium in the event of pump stop due to an electric supply failure. When the pump is active, the thrust of medium keeps the valve closed, forcing the water to flow through the anti-condensation thermostatic valve. If the event of pump stop, when the water within the generator is at high temperature, a natural circulation of the water begins, by-passing the anti-condensation valve, thus preventing the temperature in the generator from reaching dangerous high levels. The unit is provided with natural circulation valve locked. To activate its function, remove the locking screw.

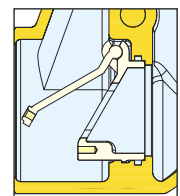

Dirt separator

In order to carry out continuous dirt separation in the system it is available the 5462 series DIRTCAL® dirt separator as accessory.

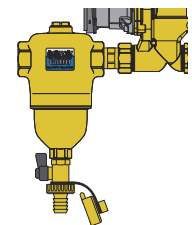

ANTI-CONDENSATION CIRCULATION UNIT

282

tech. broch. 01225

Circulation unit with anti-condensation valve, with thermostatic control of the return temperature to solid fuel generators. **With insulation.**
 System circuit connections: 1" F with union.
 Generator circuit connections: 1" F.
 Medium: water, glycol solutions.
 Max. percentage of glycol: 50%.
 Temperature range: 5-100°C.
 Max. working pressure: 10 bar.
 Temperature gauge scale: 0-120°C.

Anti-condensation valve

Temperature range: 5-100°C.
 Setting temperature: 45°C, 55°C, 60°C, 70°C.
 Setting accuracy: ±2°C.
 By-pass complete closing temperature: $T_{mix} = T_{set} + 10°C = T_r$.

Pump

High-efficiency pump: UPM3 auto L 25-70, UPML 25-95.



Generator return on LH side

Code	Connection	Connection centre distance		
28260.A2L	1" F	90 mm	with pump UPM3 Auto L 25-70	1 -
28264.UPM	1" F	90 mm	with pump UPML 25-95	1 -
28262.A2L	1" F	125 mm	with pump UPM3 Auto L 25-70	1 -
28266.UPM	1" F	125 mm	with pump UPML 25-95	1 -

Generator return on RH side

Code	Connection	Connection centre distance		
28261.A2L	1" F	90 mm	with pump UPM3 Auto L 25-70	1 -
28265.UPM	1" F	90 mm	with pump UPML 25-95	1 -
28263.A2L	1" F	125 mm	with pump UPM3 Auto L 25-70	1 -
28267.UPM	1" F	125 mm	with pump UPML 25-95	1 -

Function

The anti-condensation circulation unit performs the function of connecting the solid fuel generator to the distribution manifold, controlling the return temperature to the generator, to avoid condensation by means of the built-in thermostatic device. The unit also enables connecting the generator to the inertial storage or directly to the user system.

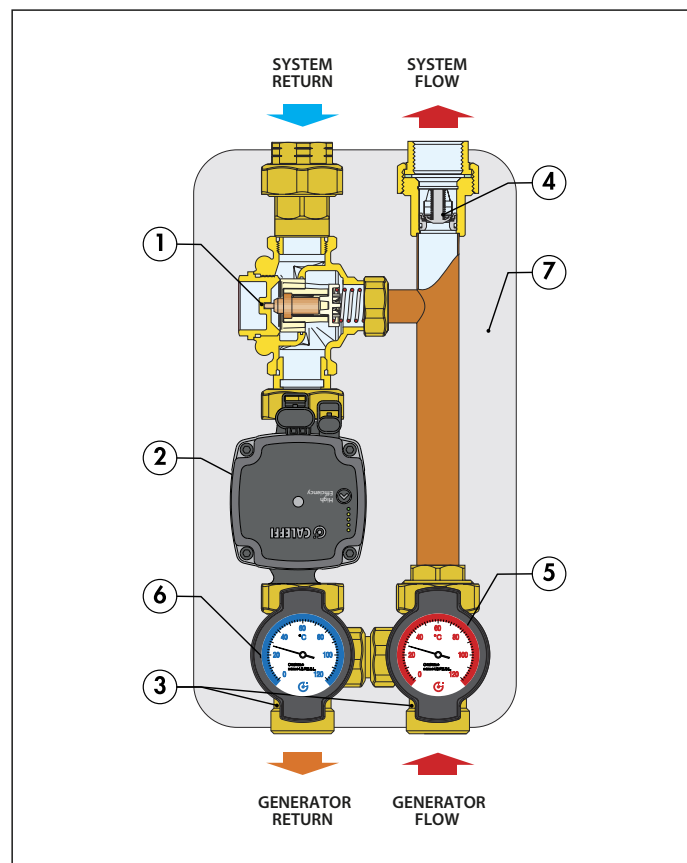

Characteristics components

- 1) Anti-condensation valve
- 2) High-efficiency pump
- 3) Shut-off valves
- 4) Check valve
- 5) Flow temperature gauge
- 6) Return temperature gauge
- 7) Insulation

Unit sizing

The unit should be selected according to the head available at the unit connections, depending on the DN, and not only according to the threaded connections. Given the system head losses, the available head of the unit pump should be evaluated.

Code completion

Setting	45°C	55°C	60°C	70°C
	4	5	6	7

For spare thermostats see page 266

Application diagram

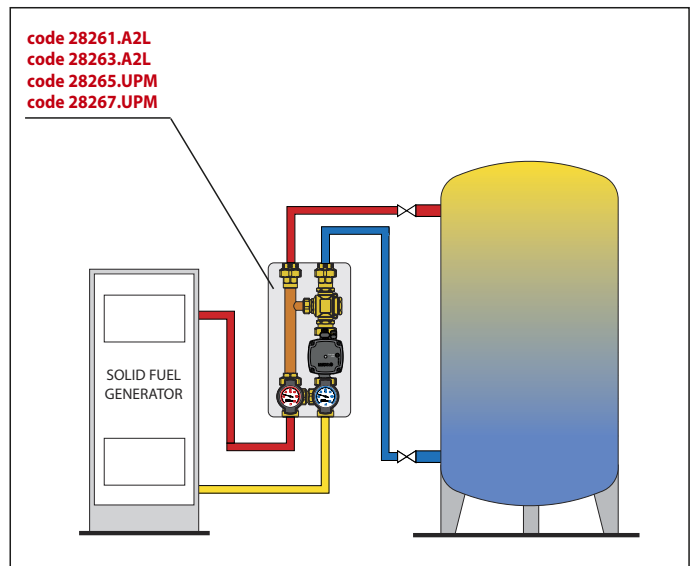
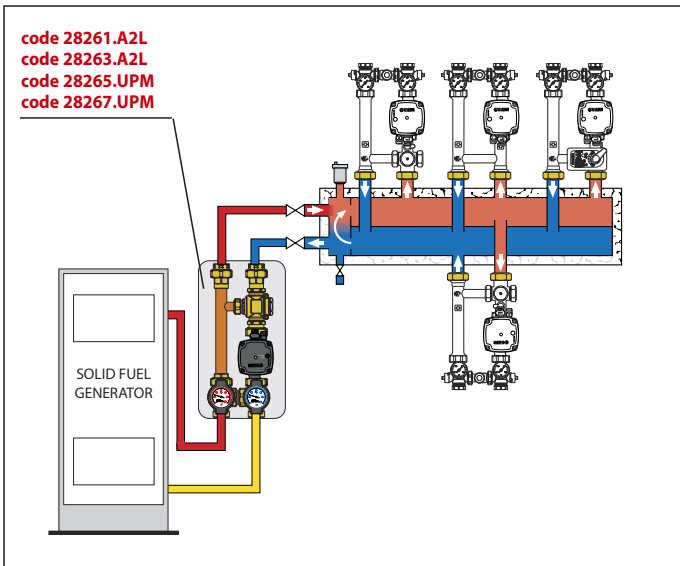
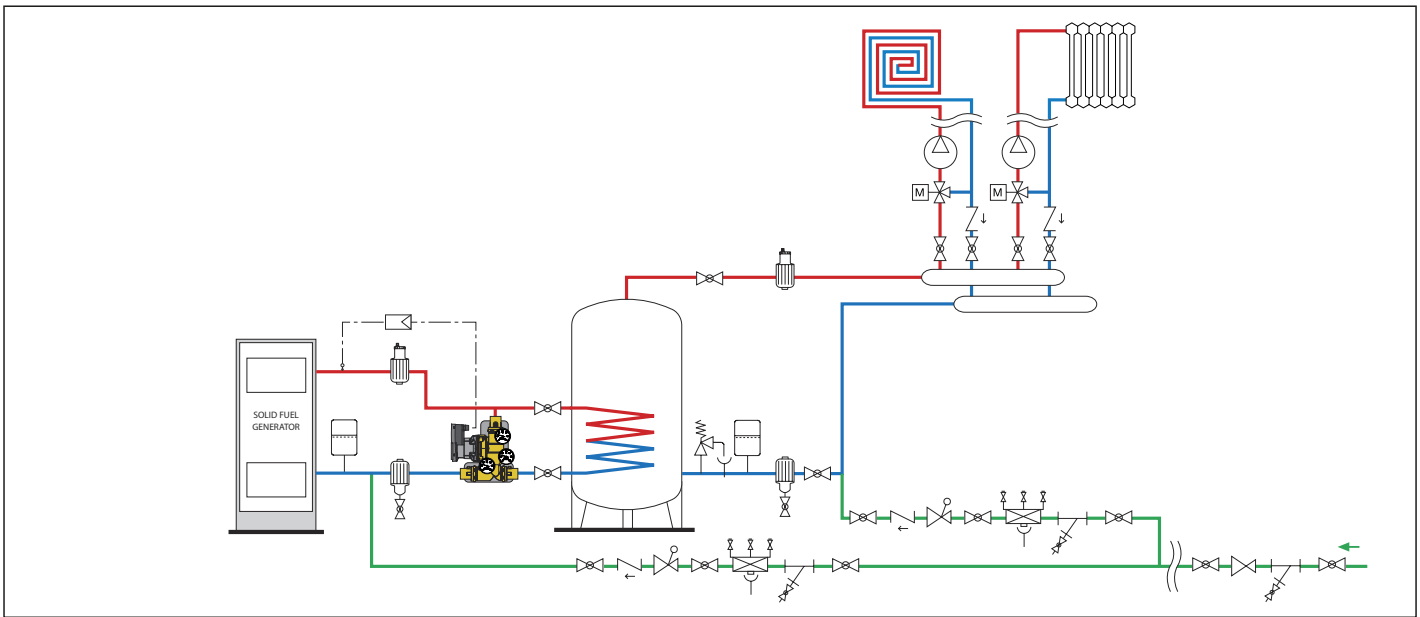
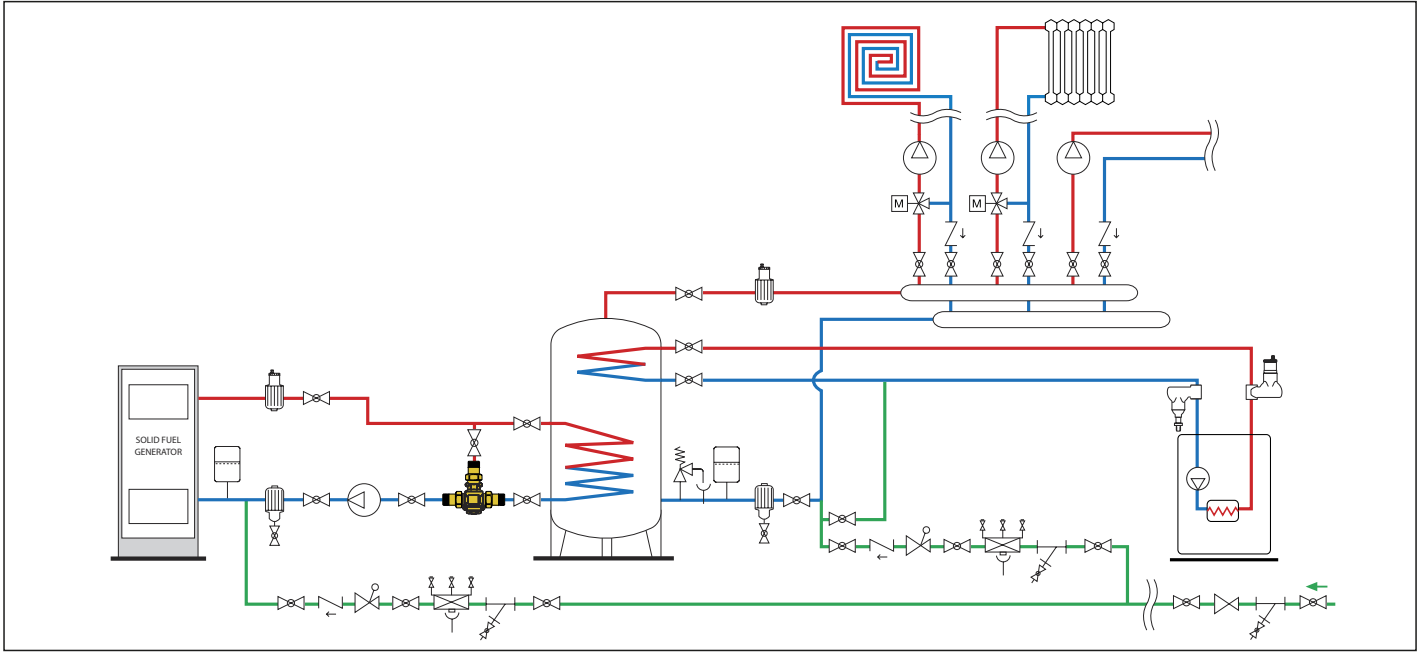

CONNECTION AND ENERGY MANAGEMENT COMPACT UNIT (heating version)

2850

tech. broch. 01259

Connection and energy management compact unit
 Female threaded connections.
 Primary side connections: 1" F.
 Secondary side system connections: 1" F.
 Secondary side boiler connections: 3/4" F.
 Medium: water, glycol solutions.
 Max. percentage of glycol: 30%.
 Temperature range: 5–100°C.
 Max. working pressure: 10 bar.
 Max. heat exchanger net output: 35 kW.
 Max. recommended primary circuit flow rate: 1,7 m³/h.
 Max. recommended secondary circuit flow rate: 1,7 m³/h.
 Anti-condensation set temperature (Tset): 55°C.
 Setting accuracy: ±2°C.
 By-pass complete closing temperature: $T_{mix} = T_{set} + 10^\circ C = Tr$.

Regulator

Supply: 230 V - 50/60 Hz.

Pumps

Primary circuit: high-efficiency YONOS PARA 25/6 RKC.
 Secondary circuit: high-efficiency variable speed pump YONOS PARA 15/6 RKA.



Code	Conn.	Primary circulation pump			
285060HE2	1"	Y. P. 15/6	without anti-condensation valve	1	-
285065HE2	1"	Y. P. 15/6		1	-

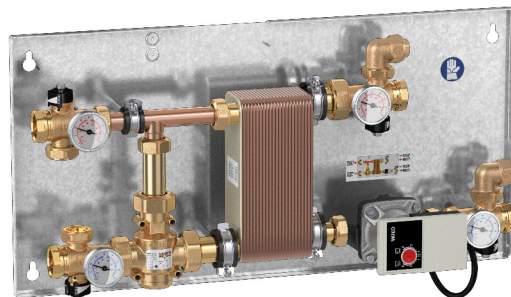

Without primary circuit circulation pump and regulator

Code	Conn.			
285060HE3	1"		1	-

2850

tech. broch. 01259

Painted steel cover RAL 9010.

Code			
285010		1	-

Function

Main functional features:

- connection of new solid fuel generators (**both boilers and residential devices, with maximum heat output of 35 kW, both with open or closed vessel**);
- automatic operation management between the solid fuel generator and boiler;
- built-in anti-condensation system (optional) for solid fuel generator;
- compact unit with reduced overall dimensions, with easy hydraulic connection.

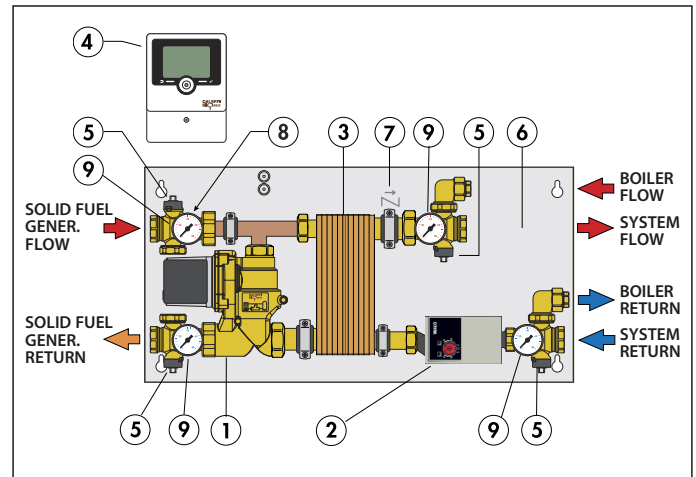

Characteristic components

- 1) Single casting unit with YONOS PARA 25/6 RKC pump, complete with anti-condensation valve (optional), primary side
- 2) YONOS PARA 15/6 RKA pump, secondary side (system)
- 3) Brazed plate heat exchanger
- 4) Digital regulator
- 5) Shut-off valve
- 6) Wall mounting template (h x w): 334 x 684 mm.
- 7) Check valve
- 8) Manual air vent
- 9) Temperature gauge

2850

tech. broch. 01259

Spare regulator for 2850 series, complete with probe.
 Supply : 230 V - 50/60 Hz.



Code			
285000		1	-

2850

tech. broch. 01259

AM1 alarm module.
 Bus connection.
 Optical visualisation of alarm and relais control.
 Relais max. contact rating: 30 V.

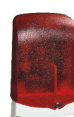

Code			
285020		1	-

**For spare thermostats
see page 266**

CONNECTION AND ENERGY MANAGEMENT COMPACT UNIT (heating version)

NEW

286

tech. broch. 01342

Connection and energy management compact unit with expansion wessel and safety relief valve.

Primary side connections: 1" M.

Secondary side system connections: 1" F.

Medium: water, glycol solutions.

Max. percentage of glycol: 30%.

Temperature range: 5-100°C.

Max. working pressure: 10 bar.

Safety relief valve setting: 3 bar.

Anti-condensation set temperature (Tset): 55°C.

Setting accuracy: ±2°C.

By-pass complete closing temperature: $T_{mix} = T_{set} + 10^{\circ}C = Tr$.

Pump: high-efficiency UPM3 Auto L 25-70.

Expansion wessel: Precharge 1,5 bar.

Volume 8 litres.

Max. working pressure: 3 bar.

To be used in systems with water volume ≤ 100 litres.

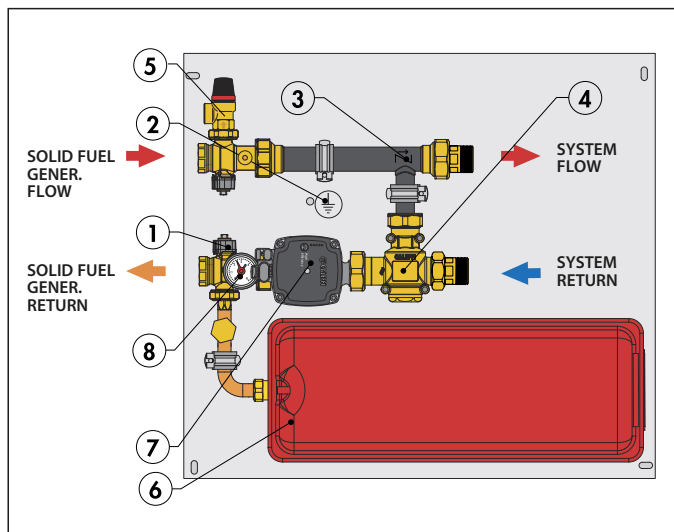

Characteristic components

- 1) Multifunction isolating valve
- 2) Earth (electrical wiring)
- 3) Check valve with low pressure loss
- 4) Thermostatic anti-condensation valve
- 5) Safety valve, 3 bar
- 6) Expansion wessel, 8 litres
- 7) Pump
- 8) Pressure gauge 0÷6 bar



Code	Conn.		
286151	1"	1	-

Application diagram

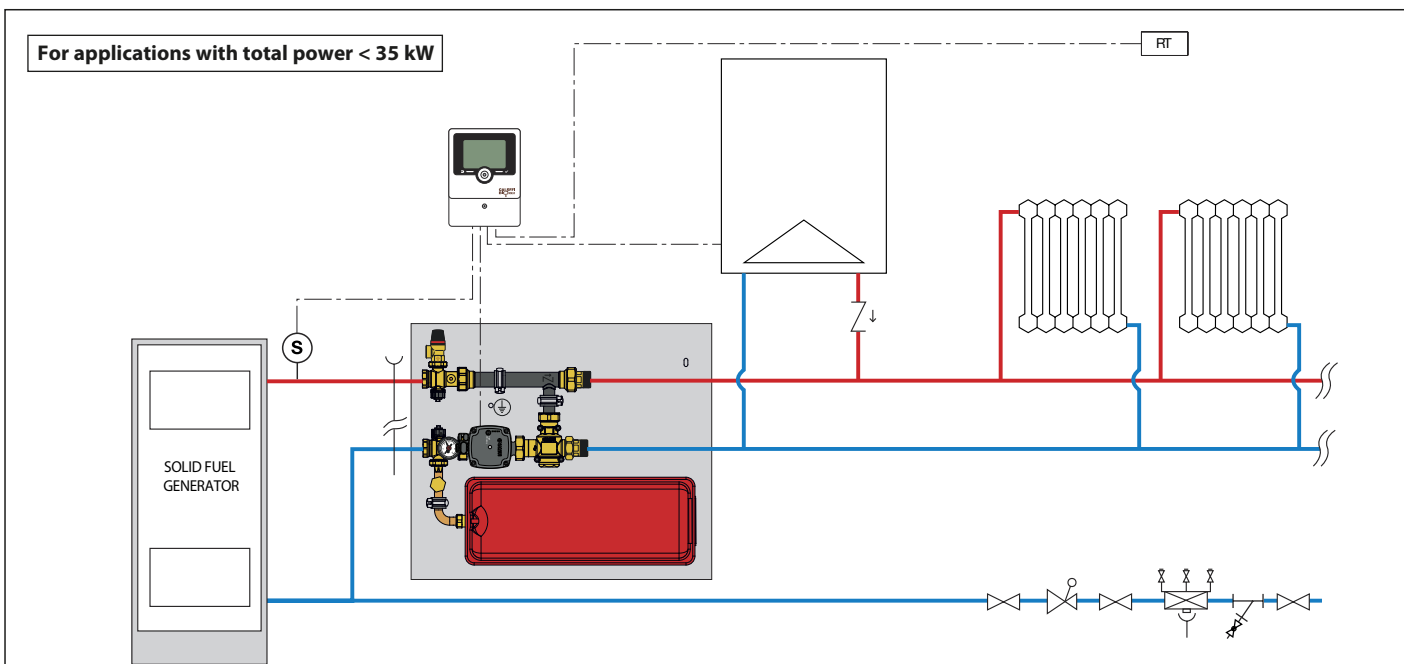

CONNECTION AND ENERGY MANAGEMENT UNIT (heating version)

2851

tech. broch. 01227

Connection and energy management unit, heating version.
 Male threaded connections.
 Medium: water, glycol solutions.
 Max. percentage of glycol: 30%.
 Temperature range: 5–100°C.
 Max. working pressure: 10 bar.
 Max. heat exchanger net output: 35 kW.
 Max. recommended primary circuit flow rate: 1,5 m³/h.
 Max. recommended secondary circuit flow rate (system): 1,5 m³/h.
 Anti-condensation set temperature (optional): 45°C, 55°C, 60°C, 70°C.
 Setting accuracy: ±2°C.
 By-pass complete closing temperature: $T_{mix} = T_{set} + 10^{\circ}C = Tr$.

Regulator

Supply: 230 V - 50/60 Hz.

Pumps

High-efficiency pump: YONOS PARA 25/6 RKA, YONOS PARA 15/6 RKA.

Diverter valve with spring return

Max. working pressure: 10 bar.
 Δp max.: 1 bar.

Diverter valve actuator with spring return

Synchronous motor.
 Normally closed.
 Supply: 230 V - 50/60 Hz.
 Opening time: 70–75 s.
 Closing time: 5–7 s.



Code



28515.WYP	3/4" M	1	–
285150WYP	3/4" M without anti-condensation valve	1	–

• Code completion

Setting	45°C	55°C	60°C	70°C
•	4	5	6	7

**For spare thermostats
see page 266**

Function

Main functional features:

- connection of new solid fuel generators (**both boilers and residential devices, with maximum heat output of 35 kW, both with open or closed vessel**) with other closed vessel generators;
- possibility of **not adding the power outputs of the two generators as described in INAIL (Italy)**;
- automatic system management with a specific digital regulator for heating circuits and simple solar thermal system;
- built-in anti-condensation system (optional) for solid fuel generator;
- easy access to components for maintenance;
- practical installation thanks to the arrangement in a box.

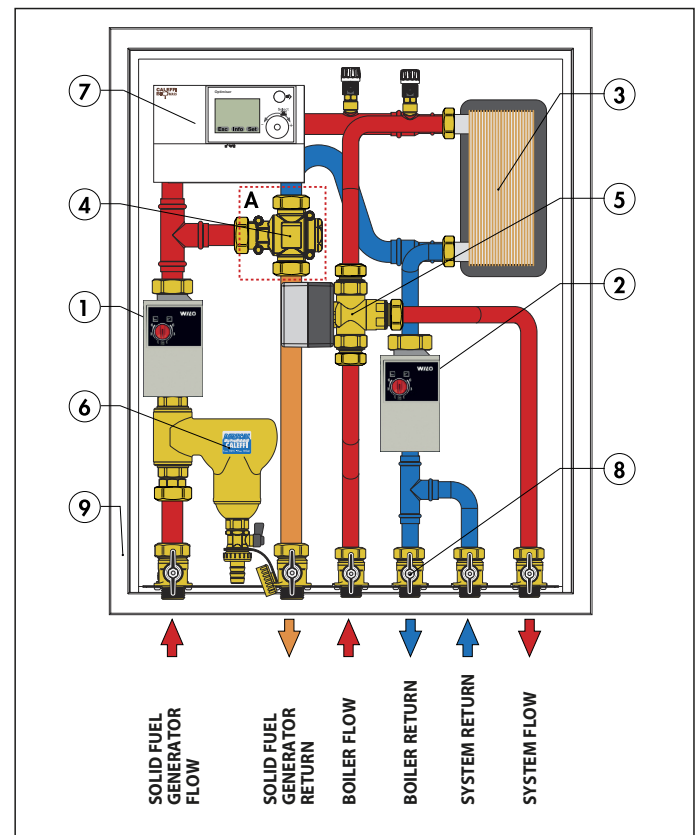

Characteristic components

- 1) Wilo YONOS PARA 25/6 RKA pump on primary side for solid fuel generator
- 2) Wilo YONOS PARA 15/6 RKA pump on secondary side (system)
- 3) Brazed plate heat exchanger
- 4) Anti-condensation valve (optional)
- 5) Three-way diverter valve with spring return
- 6) Dirt separator
- 7) Digital regulator
- 8) Shut-off ball valves
- 9) Box for wall-mounting (h x w x d): 790 x 650 x 160 mm.

Code 285150WYP without anti-condensation valve

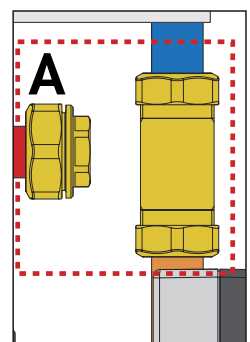

- A) Code 285150WYP without anti-condensation valve

CONNECTION AND ENERGY MANAGEMENT UNIT (heating and domestic hot water with storage version)

2853

tech. broch. 01228

Connection and energy management unit, heating and domestic hot water with storage version. Male threaded connections.
 Medium: water, glycol solutions.
 Max. percentage of glycol: 30%.
 Temperature range: 5–100°C.
 Max. working pressure: 10 bar.
 Max. heat exchanger net output: 35 kW.
 Max. recommended primary circuit flow rate: 1,5 m³/h.
 Max. recommended secondary circuit flow rate (system): 1,5 m³/h.
 Anti-condensation set temperature (optional): 45°C, 55°C, 60°C, 70°C.
 Setting accuracy: ±2°C.
 By-pass complete closing temperature: $T_{mix} = T_{set} + 10^\circ\text{C} = T_r$.

Regulator

Supply: 230 V - 50/60 Hz.

Pumps

High-efficiency pump: YONOS PARA 25/6 RKA, YONOS PARA 15/6 RKA.

Diverter valves with spring return

Max. working pressure: 10 bar.
 Δp max.: 1 bar.

Diverter valve actuator with spring return

Synchronous motor.
 Normally closed.
 Supply: 230 V - 50/60 Hz.
 Opening time: 70–75 s.
 Closing time: 5–7 s.



Code



28535.WYP	3/4" M	1	–
285350WYP	3/4" M without anti-condensation valve	1	–

• Code completion

Setting	45°C	55°C	60°C	70°C
•	4	5	6	7

**For spare thermostats
see page 266**

Function

Main functional features:

- connection of new solid fuel generators (**both boilers and residential devices, with maximum heat output of 35 kW, both with open or closed vessel**) with other closed vessel generators;
- possibility of **not adding the power outputs of the two generators as described in INAIL (Italy)**;
- automatic system management with a specific digital regulator for heating circuits, domestic water storage and simple solar thermal system;
- built-in anti-condensation system (optional) for solid fuel generator;
- easy access to components for maintenance;
- practical installation thanks to the arrangement in a box.

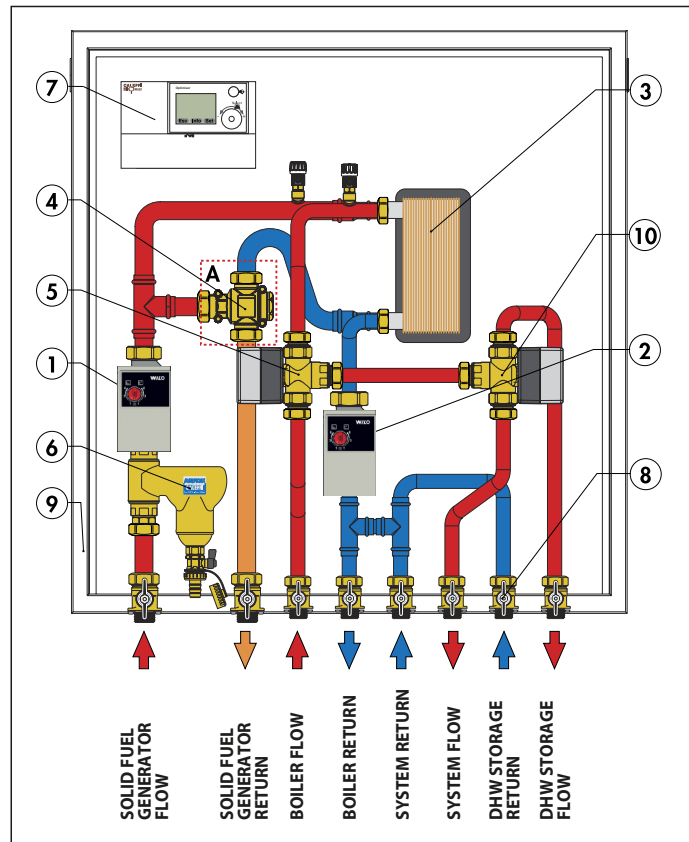

Characteristic components

- 1) Wilo YONOS PARA 25/6 RKA pump on primary side for solid fuel generator
- 2) Wilo YONOS PARA 15/6 RKA pump on secondary side (system)
- 3) Brazed plate heat exchanger
- 4) Anti-condensation valve (optional)
- 5) Three-way diverter valve with spring return
- 6) Dirt separator
- 7) Digital regulator
- 8) Shut-off ball valves
- 9) Box for wall-mounting (h x w x d): 790 x 810 x 160 mm.
- 10) Three-way diverter valve with spring return for priority on domestic water with storage

Code 285350WYP without anti-condensation valve

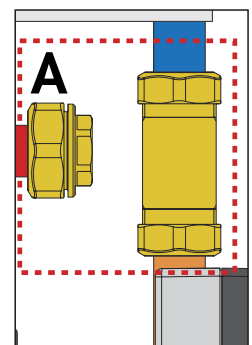

- A) Code 285350WYP without anti-condensation valve

CONNECTION AND ENERGY MANAGEMENT UNIT (heating and instantaneous domestic hot water version)

2855

tech. broch. 01229

Connection and energy management unit, heating and instantaneous domestic hot water version. Male threaded connections.
 Medium: water, glycol solutions.
 Max. percentage of glycol: 30%.
 Temperature range: 5–100°C.
 Max. working pressure: 10 bar.
 Max. heat exchanger net output: 35 kW.
 Max. recommended primary circuit flow rate: 1,5 m³/h.
 Max. recommended secondary circuit flow rate (system): 1,5 m³/h.
 Max. domestic hot water heat exchanger net output: 35 kW.
 Max. domestic hot water flow rate delivery: 1,1 m³/h.
 Anti-condensation set temperatures (optional): 45°C, 55°C, 60°C, 70°C.
 Setting accuracy: ±2°C.
 By-pass complete closing temperature: T_{mix} = T_{set}+10°C = T_r.

Regulator

Supply: 230 V - 50/60 Hz.

Pumps

High-efficiency pump: YONOS PARA 25/6 RKA, YONOS PARA 15/6 RKA.

Flow switch

Contacts normally open (NO).
 Contacts close with increasing flow at: 156 l/h.
 Contacts open with decreasing flow at: 108 l/h.

Diverter valve with spring return

Max. working pressure: 10 bar.
 Δp max.: 1 bar.

Diverter valve actuator with spring return

Synchronous motor.
 Normally closed.
 Supply: 230 V - 50/60 Hz.
 Opening time: 70–75 s.
 Closing time: 5–7 s.

Diverter ball valve for DHW priority

Max. working pressure: 10 bar.
 Δp max.: 10 bar.

Diverter ball valve actuator for DHW priority

Synchronous motor
 Supply: 230 V (±10%) - 50/60 Hz.
 Operating time (angle of rotation 90°): 10 s.



Code



28555.WYP	3/4" M	1	-
285550WYP	3/4" M without anti-condensation valve	1	-

Code completion

Setting	45°C	55°C	60°C	70°C
●	4	5	6	7

**For spare thermostats
see page 266**

Function

Main functional features:

- connection of new solid fuel generators (**both boilers and residential devices, with maximum heat output of 35 kW, both with open or closed vessel**) with other closed vessel generators;
- possibility of **not adding the power outputs of the two generators as described in INAIL (Italy)**;
- automatic system management with a specific digital regulator for heating circuits, instantaneous production of domestic hot water and simple solar thermal system;
- built-in anti-condensation system (optional) for solid fuel generator;
- easy access to components for maintenance;
- practical installation thanks to the arrangement in a box.

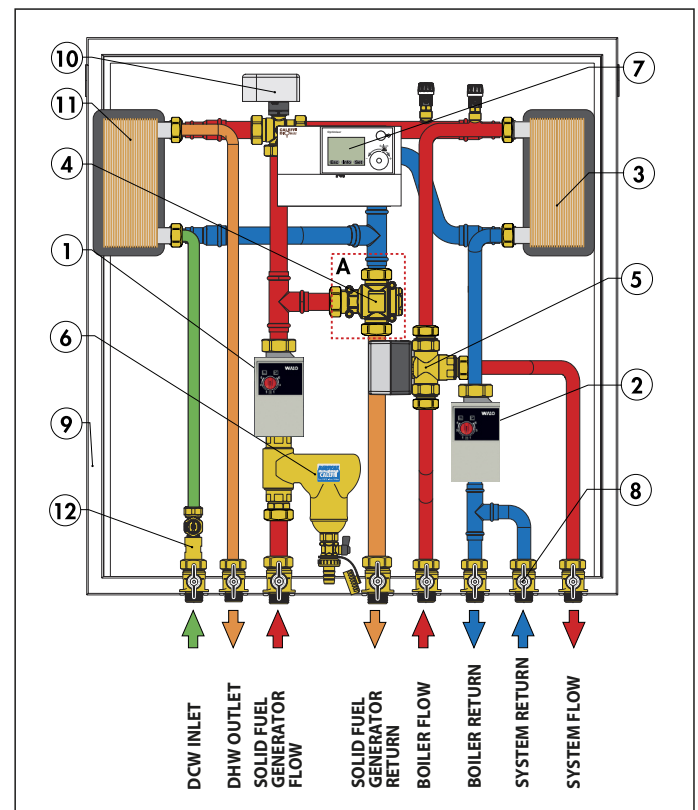

Characteristic components

- 1) Wilo YONOS PARA 25/6 RKA pump on primary side for solid fuel generator
- 2) Wilo YONOS PARA 15/6 RKA pump on secondary side (system)
- 3) Brazed plate heat exchanger for heating
- 4) Anti-condensation valve (optional)
- 5) Three-way diverter valve with spring return
- 6) Dirt separator
- 7) Digital regulator
- 8) Shut-off ball valves
- 9) Box for wall-mounting (h x w x d): 895 x 890 x 160 mm.
- 10) Three-way three point diverter ball valve for DHW priority
- 11) Brazed plate heat exchanger for DHW
- 12) Flow switch

Code 285550WYP without anti-condensation valve

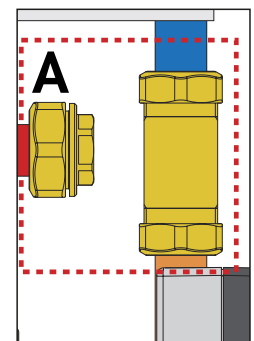

- A) Code 285550WYP without anti-condensation valve

DIGITAL REGULATOR FOR SYSTEMS WITH SOLID FUEL GENERATOR



1522

Digital regulator for systems with solid fuel generator.
Supply: 230 V (ac); $\pm 10\%$, 50/60 Hz.
Protection class: II.
Complete with three probes.

Optional probes to choose according to the type of system.



Code

152200



1

Function

The digital regulator makes it possible to combine a solid fuel generator with another type of generator already present in the heating system. The digital regulator automatically manages the two generators, receiving the signal from the probes and activating the pumps, the motorized diverter valves in the system, according to the heating circuit needs. Depending on the type and quantity of installed probes, the regulator supports the following system solutions:

- heating;
- production of domestic hot water by means of storage or instantaneous with plate heat exchanger;
- management of inertial water storage in parallel on the heating circuit or alternatively management of an independent solar system and direct inertial water storage.

The regulator has different programs which can be customized by user to several system situations.

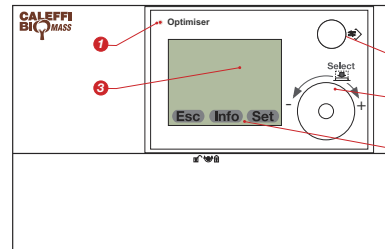

Description of controls

1. Functional status indicator LED.
2. Mini DIN connector on front of panel for PC connection.
3. Display: menu display.
4. Select knob: selection of menu, functions and parameter editing.
5. Function keys.

Program diagrams

The regulator allows the management of a thermal system complete with solid fuel generator, a boiler and an inertial water storage in parallel.

The phases of storage loading and unloading are automatically controlled, according to the system needs, with the consequent activation or deactivation of the boiler and the solid fuel generator.

Depending on the system type, different programs are available to design various functional configurations, both for the heating and the domestic hot water production.

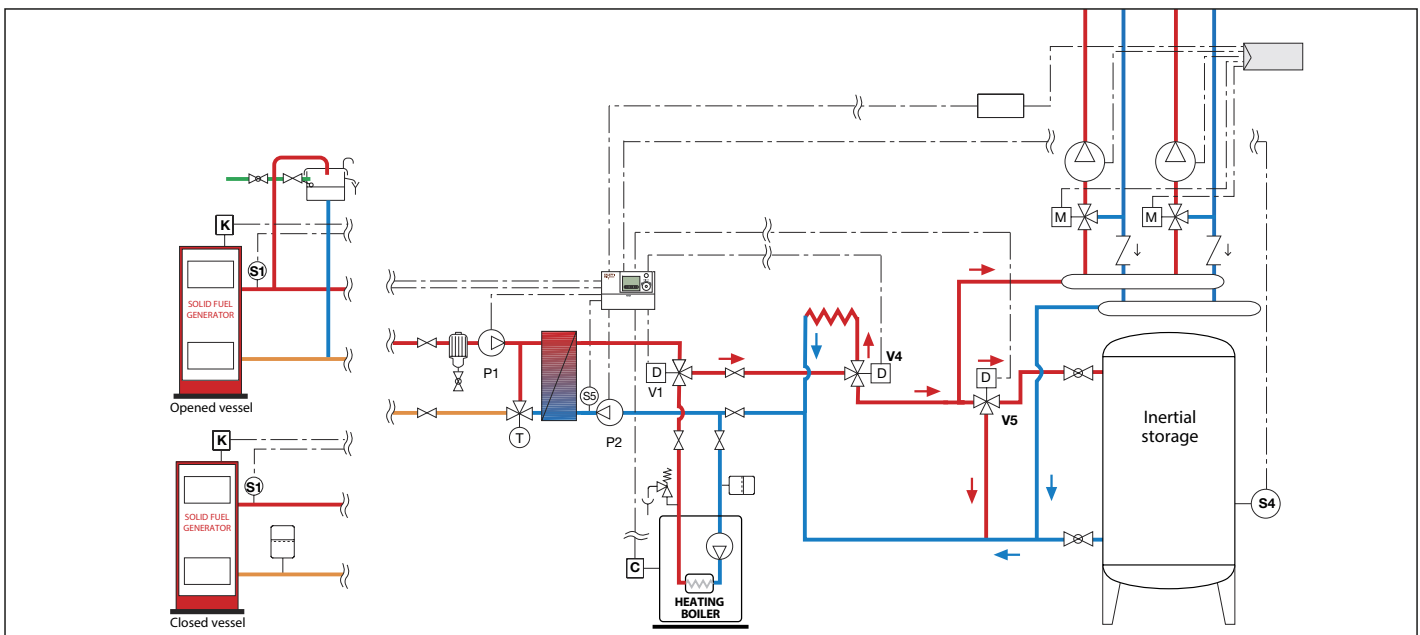

SOLID FUEL GENERATOR-TO-GAS BOILER CONNECTION KIT

Application diagram of kit SOLARINCAL 265 series with solid fuel generator

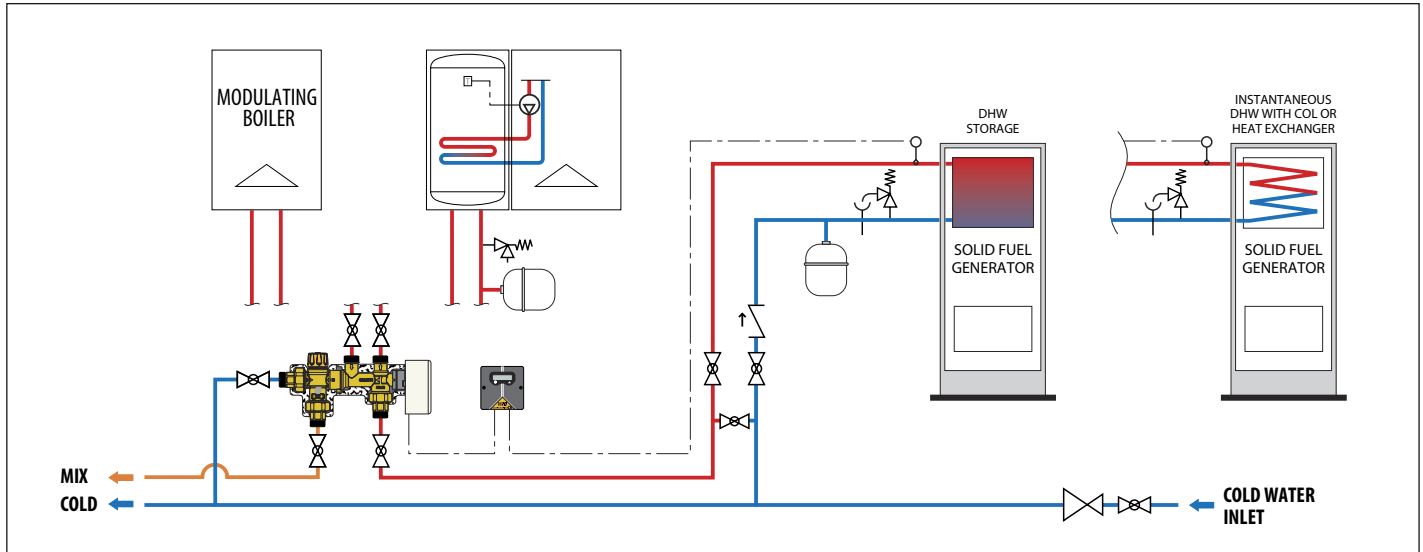

Application diagram of kit SOLARINCAL-T 262 series with solid fuel generator

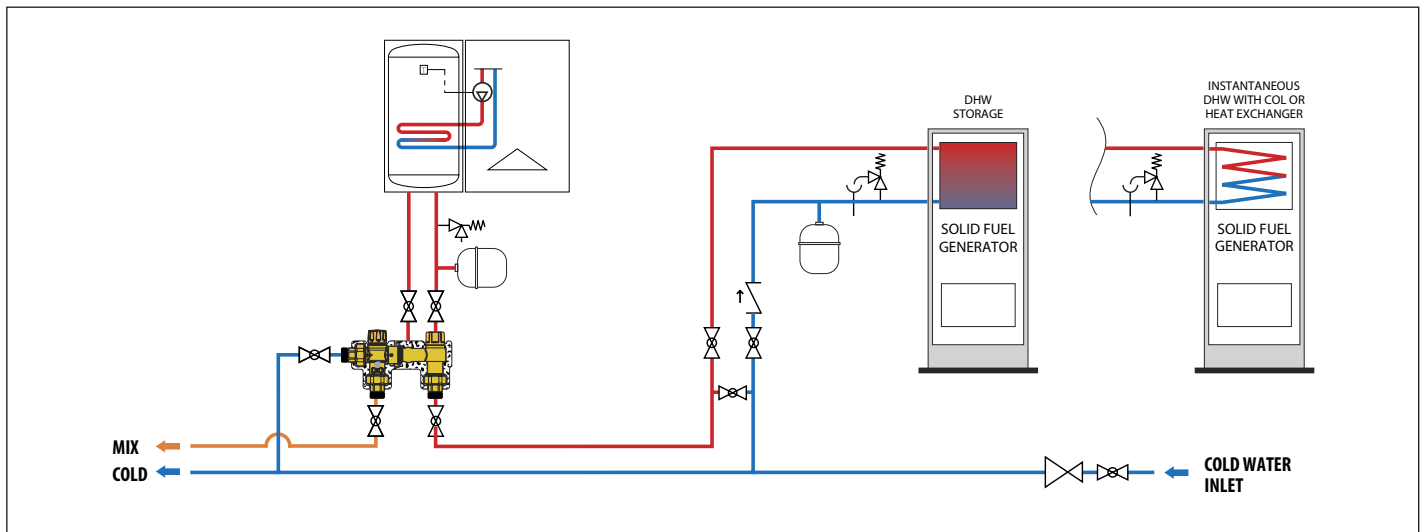

Application diagram of kit SOLARINCAL-T PLUS 263 series with solid fuel generator

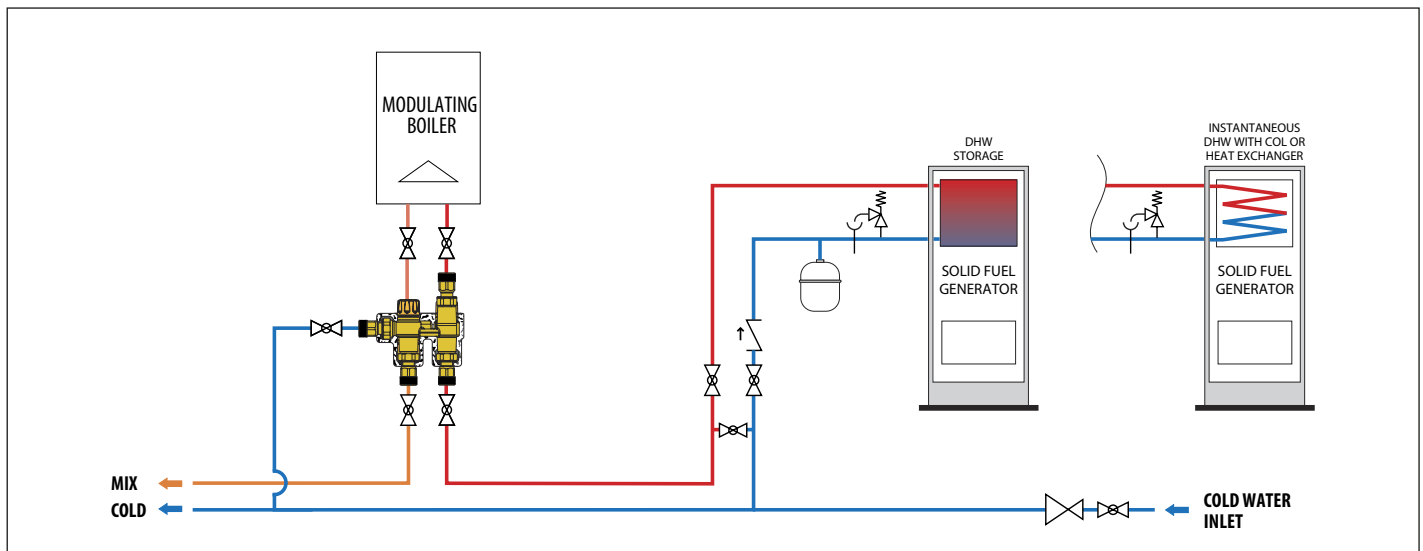

FITTING COUPLING

PRODUCT DIMENSIONS are available on www.caleffi.com

This diagram is just an indication

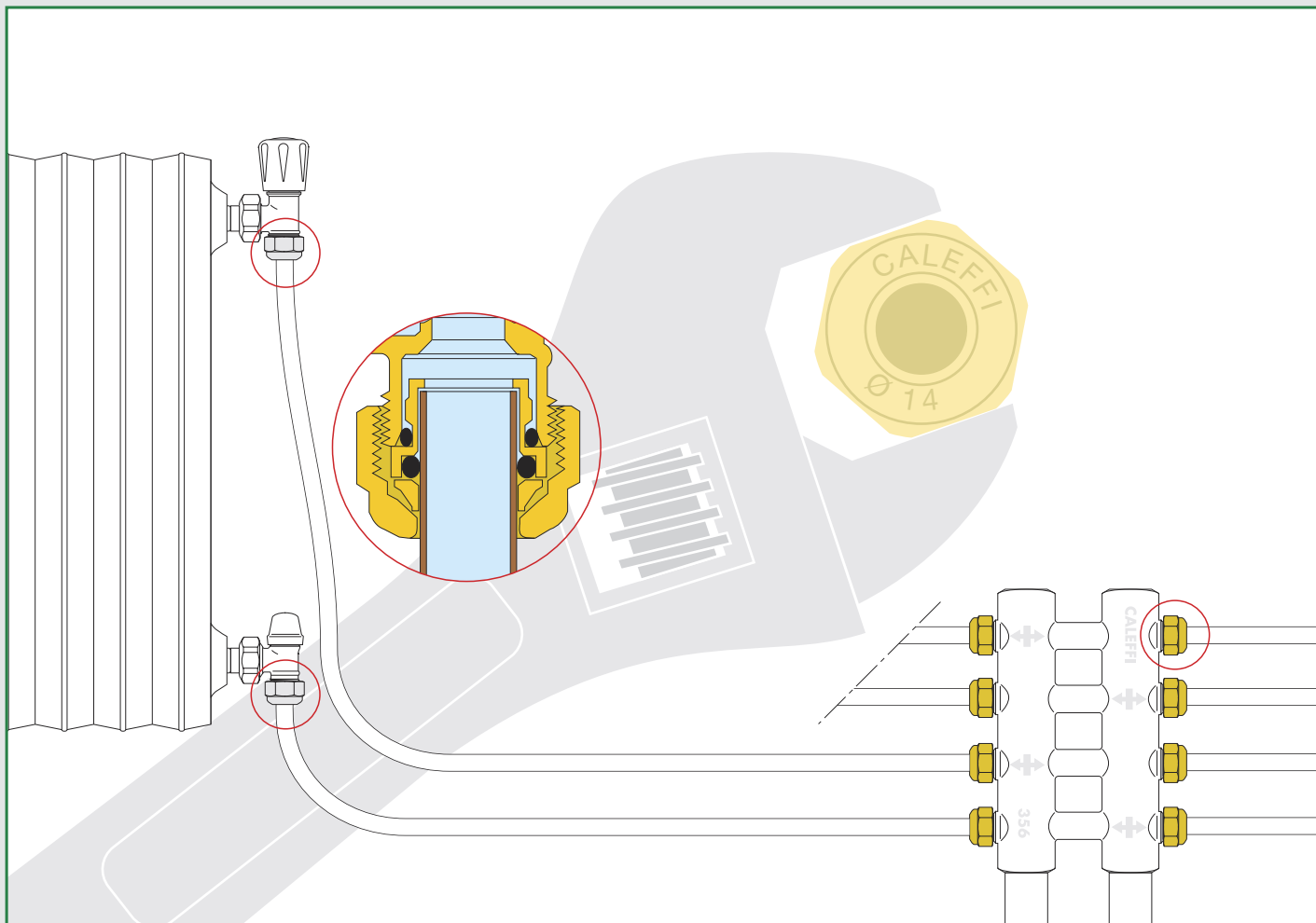

CHROME PLATED BRASS FITTINGS

23 p.1,5 pipes connection



6790 DARCAL

Fitting for multilayer plastic pipe with continuous high temperature use.

For a correct use, adjust the multilayer pipe diameter before installation using the Caleffi calibrator 679 series.

Code

679014	23 p.1,5 - Ø 14x2
679024	23 p.1,5 - Ø 16x2
679025	23 p.1,5 - Ø 16x2,25
679044	23 p.1,5 - Ø 18x2
679064	23 p.1,5 - Ø 20x2 metal ring
679065	23 p.1,5 - Ø 20x2,25
679066	23 p.1,5 - Ø 20x2,5

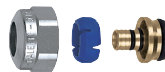

6810 DARCAL

Self-adjustable diameter fitting for single and multilayer plastic pipes.

Code

Code		Ø _{inside}	Ø _{outside}
681000	23 p.1,5	7,5- 8	12-14
681002	23 p.1,5	9 - 9,5	14-16
681001	23 p.1,5	9,5-10	12-14
681006	23 p.1,5	9,5-10	14-16
681015	23 p.1,5	10,5-11	14-16
681017	23 p.1,5	10,5-11	16-18
681024	23 p.1,5	11,5-12	14-16
681026	23 p.1,5	11,5-12	16-18
681035	23 p.1,5	12,5-13	16-18
681044	23 p.1,5	13,5-14	16-18



6810 DARCAL

Self-adjustable diameter fitting for single and multilayer plastic pipes. High chrome finish.

Code

Code		Ø _{inside}	Ø _{outside}
681101	23 p.1,5	9,5-10	12-14
681124	23 p.1,5	11,5-12	14-16



4470

Pre-assembled compression fitting, for annealed copper, hard copper, brass, mild and stainless steel. With O-Ring seal.

Code

447010	23 p.1,5 - Ø 10
447012	23 p.1,5 - Ø 12
447014	23 p.1,5 - Ø 14
447015	23 p.1,5 - Ø 15
447016	23 p.1,5 - Ø 16



4371

Compression fitting, for annealed copper, hard copper, brass, mild and stainless steel. With O-Ring seal. High chrome finish.

Code

437112	23 p.1,5 - Ø 12
437114	23 p.1,5 - Ø 14



4370

Compression fitting, for annealed copper, hard copper, brass, mild and stainless steel. With O-Ring seal.

Code

437010	23 p.1,5 - Ø 10
437012	23 p.1,5 - Ø 12
437014	23 p.1,5 - Ø 14
437015	23 p.1,5 - Ø 15
437016	23 p.1,5 - Ø 16



4380

Compression fitting, for copper pipes. With PTFE seal.

Code

438010	23 p.1,5 - Ø 10
438012	23 p.1,5 - Ø 12
438014	23 p.1,5 - Ø 14
438015	23 p.1,5 - Ø 15
438016	23 p.1,5 - Ø 16
438018	23 p.1,5 - Ø 18 with metal olive

23 p.1,5 M - Ø 18

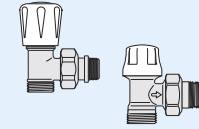

Series: 338

339

425

426

222 232

223 233

227 237

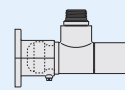
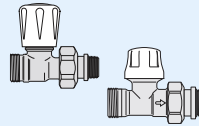

Series: 4001

4003

4004

4005

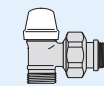

Series: 340

341

342

343

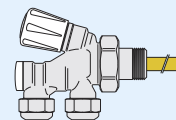
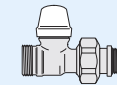

Series: 456

455

4501

348

452

328

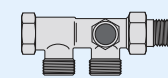
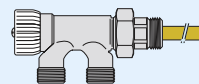

Series: 382

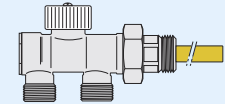

CHROME PLATED BRASS FITTINGS

3/4" pipes connection

6792 DARCAL
 Fitting for multilayer plastic pipe with continuous high temperature use.



For a correct use, adjust the multilayer pipe diameter before installation using the Caleffi calibrator 679 series.

Code	
679264	3/4" - Ø 20x2
679265	3/4" - Ø 20x2,25
679266	3/4" - Ø 20x2,5

4375
 Compression fitting, for copper pipes. With O-Ring seal.



Code	
437510	3/4" - Ø 10
437512	3/4" - Ø 12
437514	3/4" - Ø 14
437515	3/4" - Ø 15
437516	3/4" - Ø 16
437518	3/4" - Ø 18

6815 DARCAL
 Self-adjustable diameter fitting for single and multilayer plastic pipes.



Code		Ø _{inside}	Ø _{outside}
681502	3/4"	7,5- 8	12-14
681500	3/4"	9 - 9,5	14-16
681501	3/4"	9,5-10	12-14
681506	3/4"	9,5-10	14-16
681515	3/4"	10,5-11	14-16
681517	3/4"	10,5-11	16-18
681524	3/4"	11,5-12	14-16
681526	3/4"	11,5-12	16-18
681535	3/4"	12,5-13	16-18
681537	3/4"	12,5-13	18-20
681546	3/4"	13,5-14	18-20
681555	3/4"	14,5-15	18-20
681556	3/4"	15 -15,5	18-20
681564	3/4"	15,5-16	18-20

4385
 Compression fitting, for copper pipes. With PTFE seal.



Code	
438512	3/4" - Ø 12
438514	3/4" - Ø 14
438515	3/4" - Ø 15
438516	3/4" - Ø 16
438518	3/4" - Ø 18

3/4" M - Ø 18

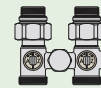

- Series:** 3010
 3011
 3012
 3013
 3014
 3015

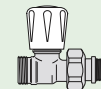
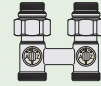

- Codes:** 338452
 339452
 340452
 342452
 343452

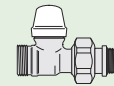

BRASS FITTINGS

1/2" pipes connection



5914
Fitting for plastic pipe.

Code	1/2"	Ø _{inside}	Ø _{outside}
591401	1/2"	8	13
591402	1/2"	10	12
591405	1/2"	10	15
591414	1/2"	11,6	16
591424	1/2"	12	16
591433	1/2"	13	16



58124
Nut and olive or single groove seal in PTFE, for copper pipe.

Code	1/2"	Ø
581240	1/2"	+ single groove Ø 10
581242	1/2"	+ single groove Ø 12
581244	1/2"	+ single groove Ø 14
581245	1/2"	+ single groove Ø 15
581246	1/2"	+ olive Ø 16

1/2" M - Ø 16



Series: 349
592
598



23 p.1,5 pipes connection



6791 DARCAL
Fitting for multilayer plastic pipe with continuous high temperature use.

For a correct use, adjust the multilayer pipe diameter before installation using the Caleffi calibrator 679 series.

Code	23 p.1,5	Ø
679114	23 p.1,5	- Ø 14x2
679124	23 p.1,5	- Ø 16x2
679125	23 p.1,5	- Ø 16x2,25
679144	23 p.1,5	- Ø 18x2



4460
Pre-assembled compression fitting, for annealed copper, hard copper, brass, mild and stainless steel. With O-Ring seal.

Code	23 p.1,5	Ø
446010	23 p.1,5	- Ø 10
446012	23 p.1,5	- Ø 12
446014	23 p.1,5	- Ø 14
446015	23 p.1,5	- Ø 15
446016	23 p.1,5	- Ø 16

23 p.1,5 M - Ø 18



Series: 350
351
349

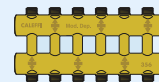

Series: 356
357
385
161

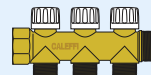

Series: 354

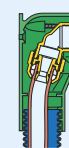

Series: 933 940
941 942
943 944
945 946
947 948



6800 DARCAL
Self-adjustable diameter fitting for single and multilayer plastic pipes.

Code	23 p.1,5	Ø _{inside}	Ø _{outside}
680000	23 p.1,5	7,5- 8	12-14
680002	23 p.1,5	9 - 9,5	14-16
680001	23 p.1,5	9,5-10	12-14
680006	23 p.1,5	9,5-10	14-16
680015	23 p.1,5	10,5-11	14-16
680017	23 p.1,5	10,5-11	16-18
680024	23 p.1,5	11,5-12	14-16
680026	23 p.1,5	11,5-12	16-18
680035	23 p.1,5	12,5-13	16-18
680044	23 p.1,5	13,5-14	16-18



3470
Compression fitting, for annealed copper, hard copper, brass, mild and stainless steel. With O-Ring seal.

Code	23 p.1,5	Ø
347010	23 p.1,5	- Ø 10
347012	23 p.1,5	- Ø 12
347014	23 p.1,5	- Ø 14
347015	23 p.1,5	- Ø 15
347016	23 p.1,5	- Ø 16

6800 DARCAL

Self-adjustable diameter fitting for single and multilayer plastic pipes.



Code	23 p.1,5	Ø _{inside}	Ø _{outside}
680055	23 p.1,5	14,5-15	18-20
680064	23 p.1,5	15,5-16	18-20

BRASS FITTINGS

3/4" pipes connection

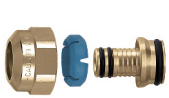

6795 DARCAL

Fitting for multilayer plastic pipe with continuous high temperature use.

For a correct use, adjust the multilayer pipe diameter before installation using the Caleffi calibrator 679 series.

Code

679514	3/4"	- Ø 14 x 2
679524	3/4"	- Ø 16 x 2
679525	3/4"	- Ø 16 x 2,25
679544	3/4"	- Ø 18 x 2
679564	3/4"	- Ø 20 x 2
679565	3/4"	- Ø 20 x 2,25
679566	3/4"	- Ø 20 x 2,5



6805 DARCAL

Self-adjustable diameter fitting for single and multilayer plastic pipes.

Code

Code	Øinside	Øoutside
680507	3/4"	7,5- 8 10,5-12
680502	3/4"	7,5- 8 12 -14
680503	3/4"	8,5- 9 12 -14
680500	3/4"	9 - 9,5 14 -16
680501	3/4"	9,5-10 12 -14
680506	3/4"	9,5-10 14 -16
680515	3/4"	10,5-11 14 -16
680517	3/4"	10,5-11 16 -18
680524	3/4"	11,5-12 14 -16
680526	3/4"	11,5-12 16 -18
680535	3/4"	12,5-13 16 -18
680537	3/4"	12,5-13 18 -20
680544	3/4"	13,5-14 16 -18
680546	3/4"	13,5-14 18 -20
680555	3/4"	14,5-15 18 -20
680556	3/4"	15 -15,5 18 -20
680564	3/4"	15,5-16 18 -20
680505	3/4"	17 22,5



6802 DARCAL

Compression ends fitting for multilayer pipe with fitting M-F.

Code

680285	3/4" F - Ø 25x2,5
680296	3/4" F - Ø 26x3



5915

Fitting for plastic pipe.

Code

591565	3/4"	Ø 16-21
591566	3/4"	Ø 16-22



58125

Nut and olive or single groove seal in PTFE, for copper pipe.

Code

581254	3/4"	+ single groove Ø 14
581256	3/4"	+ single groove Ø 16
581258	3/4"	+ olive Ø 18



3475

Compression fitting, for annealed copper, hard copper, brass, mild and stainless steel. With O-Ring seal.

Code

347510	3/4"	- Ø 10
347512	3/4"	- Ø 12
347514	3/4"	- Ø 14
347515	3/4"	- Ø 15
347516	3/4"	- Ø 16
347518	3/4"	- Ø 18



3475..S1

Compression fitting for annealed copper, hard copper, brass, mild steel and stainless steel pipes. With O-Ring seal. Specific to be used with manifolds 668...S1 series.

Code

347512S1	3/4"	- Ø 12
347514S1	3/4"	- Ø 14

1" pipes connection



6806 DARCAL

Self-adjustable diameter fitting for single and multilayer plastic pipes.

Code

Code	Øinside	Øoutside
680687	1"	17,5 25
680605	1"	19,5 25

3/4" M - Ø 18



Series: 592



Series: 650

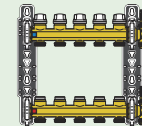

Series: 662
6620
6621
663

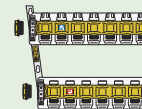

6630
6631

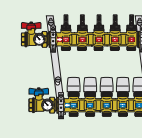

666...S1*
667...S1*
668...S1*

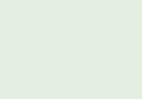

664
665
669
657

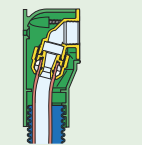

Series: 933
940
941
942
943
945
946



* Do not use with copper pipe fittings 347 and 5812 series

1" M - Ø 25



Series: 941
942

We reserve the right to change our products and their relevant technical data, contained in this publication, at any time and without prior notice.

The products in this catalogue have been designed, manufactured and factored by Caleffi in accordance with the requirements of EN ISO 9001 standard.
Factored products, listed by series in the index, are clearly identified by the "green dot ●".



CALEFFI S.p.A. · S.R.229, N.25 · 28010 Fontaneto d'Agogna (NO) · Italy · Tel. +39 0322 8491 · Fax +39 0322 863723
info@caleffi.com www.caleffi.com

© 2018 Copyright Caleffi