

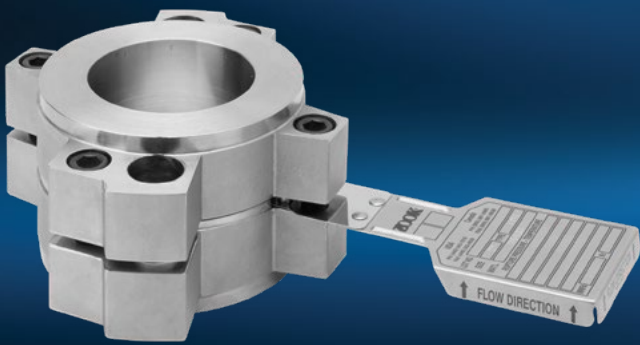

FA Series Forward-Acting Rupture Disk System



Safety through knowledge and performance.

FA Series Forward-Acting Rupture Disk System

In a continued effort to provide cutting edge products and technologies for rupture disk users, ZOOK is pleased to introduce our FA Series of Rupture Disks and Holders. The FA Series offers one unique holder design for use with multiple types of ZOOK Forward-Acting metal rupture disks.

Features / Benefits

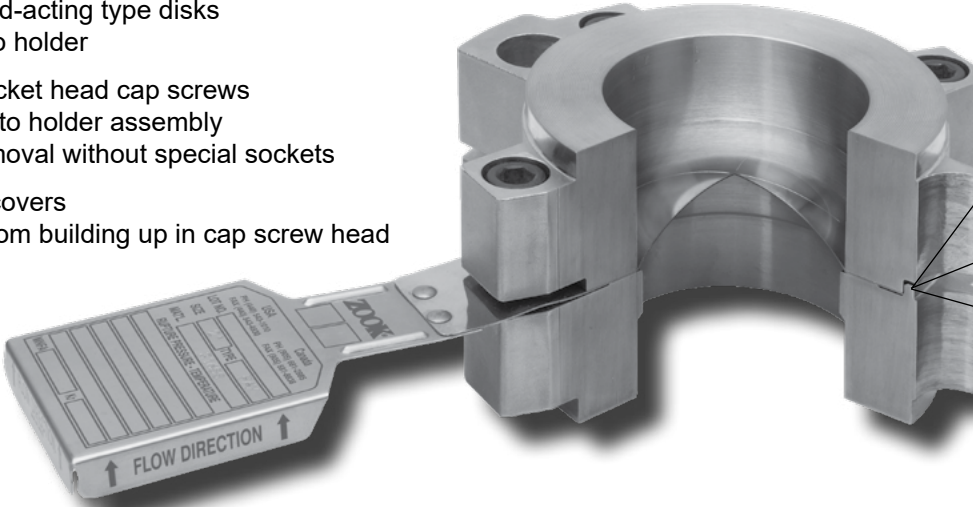
- Pre-Torque Design
 - Pre-assembly of a rupture disk into a holder prior to field installation
 - Removal of the assembly from the piping system for inspection without disturbing the seal integrity of the rupture disk
 - Pre-torque bolts properly seat the disk by engaging the holder bite
 - One holder design
 - Accepts multiple disk designs
 - Disk dome is contained within the holder assembly
 - Prevents damaging the disk during installation into mating flanges
 - Locating pin
 - Allows only forward-acting type disks to be mounted into holder
 - Fluoropolymer coated socket head cap screws
 - Resists corroding to holder assembly
 - Provides easy removal without special sockets
 - Polyethylene cap screw covers
 - Prevents debris from building up in cap screw head
- 
- Sizes 1" thru 12"
 - Standard holder materials:
 - Carbon Steel, 316SS, Hastelloy
 - Holder information is permanently affixed to the O.D. of holder
 - Bubble tight metal-to-metal bite and disk seal
 - Flow direction arrows on disk tag and holder
 - Provides permanent visual verification that holder assembly is properly oriented in the piping system
 - Flange class and type specific
 - Guards against installing an assembly into mating flanges with a different pressure rating than the rupture disk holder
 - Positioning hole in mounting lug
 - Located in the exact position as the mating flange
 - Allows for proper alignment
 - Can be used as an extra "hand" when installing into horizontal piping

FA Series Forward-Acting Rupture Disk System

FAC-R

- Composite design with process side ring
- Operating ratio up to 85%



FAC-V

- Composite design with vacuum support
- Operating ratio up to 85%



FAX

- Scored metal design
- Operating ratio up to 90%

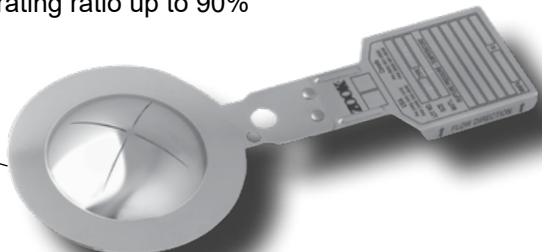

Safety Relief Valve Protection

When disk is mounted under a Relief Valve, the working components of the valve are isolated from hostile environments.

Option Liners

TFE liners are available to provide protection from corrosive media. Note that the maximum temperature ratings for disks supplied with liners is lower than the unlined disk.

FAC Rupture Disk Features

- Designed for Non-fragmentation
- Standard operating ratio of 80% of the marked rating on disk tag - may be extended to 85% of the minimum burst pressure¹
- Excels in liquid, gas, or two-phase applications
- Standard manufacturing ranges of 0%, -5%, and -10% ensures marked rating on disk tag does not exceed the MAWP of equipment
- FAC-V designed to withstands full vacuum
- Unique design ensures proper disk orientation into holder
- 3-dimensional stainless steel tag is standard
- CE, and TUV compliance available (contact ZOOK for ASME UD marking)

FAX Rupture Disk Features

- Designed for Non-fragmentation
- Standard operating ratio of 85% of the marked rating on disk tag - may be extended to 90% of the minimum burst pressure¹
- Excels in liquid, gas, or two-phase applications
- Standard manufacturing ranges of 0%, -5%, and -10% ensures marked rating on disk tag does not exceed the MAWP of equipment
- Minimum published pressures withstand full vacuum without vacuum support
- Resists product build-up. The smooth concave side of the disk is exposed to the process media
- Unique design ensures proper disk orientation into holder
- 3-dimensional stainless steel tag is standard
- ASME UD (gas service only), CE, and TUV compliance available



Certified Flow Resistance Factors (K_f)

Disk Type	K _f l (Liquid)	K _f g (Gas)
FAC-R	TBD	TBD
FAC-V	TBD	TBD
FAX	TBD	0.39



FA Series Specifications

Holder Dimensions / Specifications

Nominal Size	Available ANSI Flange Class*	Minimum Height (in)♦	Standard Height (in)			Weight (lbs.) (Short Pattern)	Number of Cap Screws	Cap Screws Hex Size	Gauge tap (NPT)**
			Short Pattern FAH 	Mid Pattern FAH-LP1 	Long Pattern FAH-LP2 				
1"	150/300/600	1-9/16"	2-1/8"	2-11/32"	2-9/16"	3.8	4	3/16"	1/8", 1/4"
1-1/2"	150/300/600	1-11/16"	2-1/4"	2-29/32"	3-9/16"	6.4	4	1/4"	1/8", 1/4"
2"	150/300/600	2-5/32"	2-23/32"	3-15/16"	5-5/32"	9.0	4	5/16"	1/8", 1/4"
3"	150/300/600	2-9/16"	3-1/8"	4-15/16"	6-23/32"	16.6	4	3/8"	1/8", 1/4"
4"	150/300	2-19/32"	3-5/32"	5-31/32"	8-3/4"	22.5	4	3/8"	1/8", 1/4"
6"	150/300	3-7/32"	3-7/16"	6-25/32"	10-3/32"	36.00	8	5/16"	1/8", 1/4"
8"	150/300	4-1/16"	4-5/8"	9-1/32"	13-15/32"	53.4	8	3/8"	1/8", 1/4"
10"	150	4-3/4"	5-21/32"	11-5/32"	16-11/16"	99.8	12	3/8"	1/8", 1/4"
12"	150/300	5-1/16"	6-17/32"	13-5/32"	19-25/32"	136.00	12	1/4"	1/8", 1/4"

Notes:

* Holders are also available to fit DIN and JIS flanging. Contact ZOOK for details.

♦ Minimum height specified in table above will maintain the pre-torque feature of the rupture disk holder. Refer to ASME/ANSI B16.5 pipe flanges and flange fittings (Table 2) for max allowable pressure/temperature ratings per flange class.

Options / Accessories

Mid/Long Pattern

- Can be machined to meet existing piping specifications
- Prevents rupture disk membrane from protruding beyond the outlet holder after burst

Replacement Fluoropolymer Coated Cap Screws



Cap Screw Specifications*	
Type	Socket Head
Material	Alloy Steel
Hardness	38-43-RC
Threads	UNRF 3A

* Required to meet Pre-Torque specifications

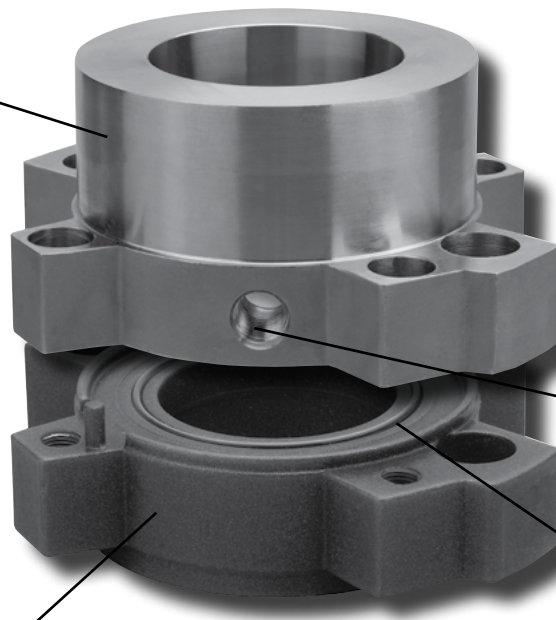

Special Coating

- Fluoropolymer Teflon Sintered (FS)
- Provides durable, non-stick surface (Requires O-Ring Seal)

Gaskets

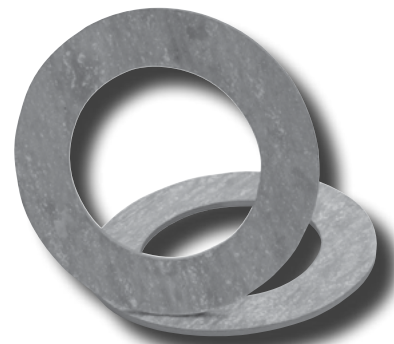

Gauge Tap**

- Used for monitoring pressure / temperature at rupture disk location
- Also available on inlet holder

O-Ring Seal

- Teflon encapsulated Viton



Teflon – TM DuPont
Hastelloy C – TM Haynes International

FA_012018

Visit us at www.zookdisk.com

SERVING AMERICA, CENTRAL & SOUTH AMERICA

16809 Park Circle Drive
Chagrin Falls, Ohio 44022
United States

Toll Free: +1 800 543 1043
Phone: +1 440 543 1010
Fax: +1 440 543 4930
E-mail: sales@zookdisk.com

SERVING EUROPE, MIDDLE EAST & AFRICA

Navigation House, Bridge St.
Killamarsh, Sheffield, S21 1AL
United Kingdom

Phone: +44 (0) 1909 560999
Fax: +44 (0) 1909 560860
E-mail: sales.europe@zookdisk.com

SERVING CANADA

4400 South Service Road
Burlington, Ontario, L7L 5R8
Canada

Toll Free: +1 800 370 6057
Phone: +1 905 681 2885
Fax: +1 905 681 8838
E-mail: sales.canada@zookdisk.com

SERVING ASIA PACIFIC

Unit No. 23A-05, Menara Landmark
No.12, Jalan Ngee Heng
80000 Johor Bahru, Johor,
Malaysia

Phone: +60 (7) 2910099
Fax: +60 (7) 2910096
E-mail: sales.asia@zookdisk.com



Safety through knowledge and performance.